

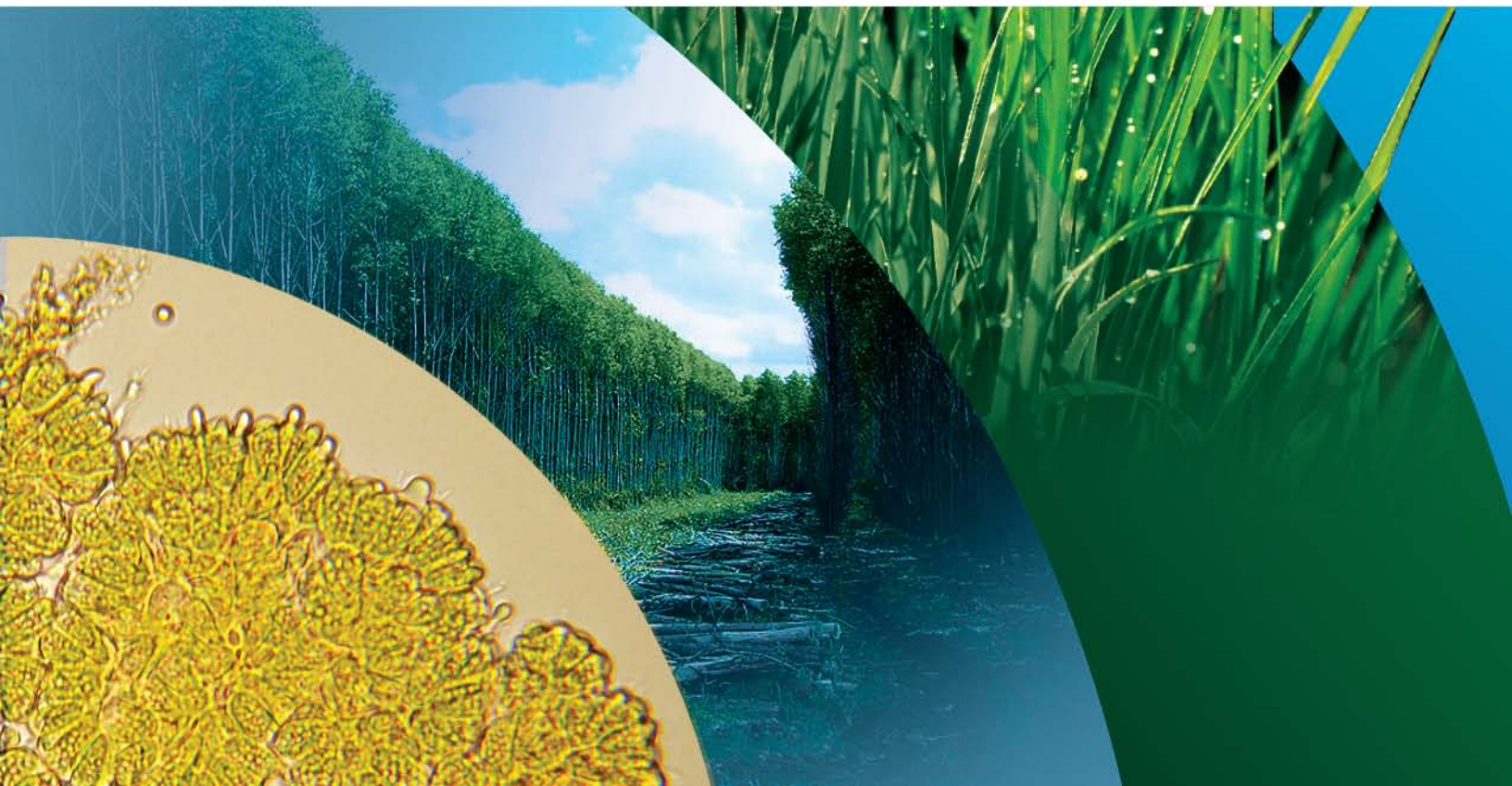

BIOMASS Multi-Year Program Plan

November 2010



EXECUTIVE SUMMARY

The Biomass Program is one of the nine technology development programs within the Office of Energy Efficiency and Renewable Energy (EERE) at the U.S. Department of Energy (DOE). This Multi-Year Program Plan (MYPP) sets forth the goals and structure of the Biomass Program. It identifies the research, development, demonstration and deployment (RDD&D) activities the Program will focus on over the next five years, and outlines why these activities are important to meeting the energy and sustainability challenges facing the nation.

This MYPP is intended for use as an operational guide to help the Biomass Program manage and coordinate its activities, and as a resource to help articulate its mission and goals to management and the public.

Biomass Program Mission and Goals

The mission of the Biomass Program (the Program) is to:

Develop and transform our renewable biomass resources into cost-competitive, high-performance biofuels, bioproducts, and biopower through targeted research, development, demonstration, and deployment supported through public and private partnerships.

The goals of the Program are to develop sustainable, cost-competitive biomass utilization technologies to:

- *Enable the production of biofuels nationwide and reduce dependence on oil through the creation of a new domestic bioenergy industry supporting the EISA goal of 36 bgy of renewable transportation fuels by 2022, and*
- *Increase biopower's contribution to national renewable energy goals through increasing biopower generating capacity.*

Technology Portfolio

The Program manages a diverse portfolio of technologies across the spectrum of applied RDD&D within the dynamic context of changing budgets and administrative priorities. The portfolio is organized to reflect the biomass-to-bioenergy supply chain – from the farmer's field to the end user (see Figure A).

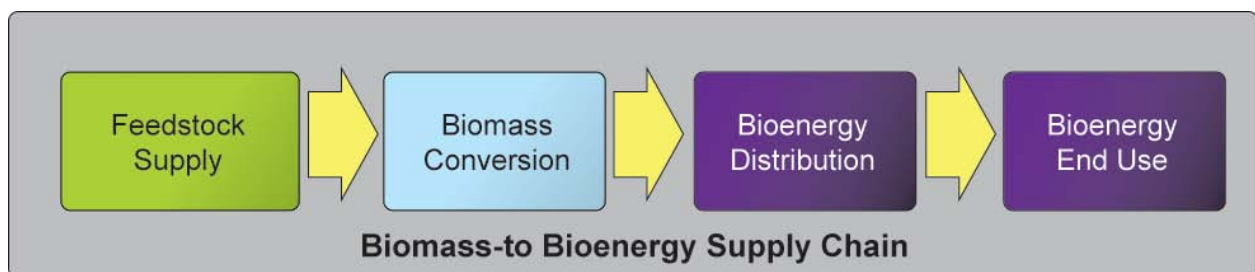

Figure A: Biomass-to-Bioenergy Supply Chain

The Program has developed a coordinated framework for managing its portfolio based on systematically investigating, evaluating, and down-selecting the most promising opportunities

across a wide range of emerging technologies and technology readiness levels (TRLs). This approach is intended to support a diverse technological portfolio in applied research and development, while identifying the most promising targets for follow-on industrial-scale demonstration and deployment.

Key components of the portfolio include:

- research and development of a sustainable, high-quality feedstock supply system;
- research and development of biomass conversion technologies;
- industrial-scale demonstration and validation of integrated biorefineries and biopower generation; and
- cross-cutting sustainability, analysis, and market expansion activities.

Technology Development Timeline and Key Activities

In order to achieve the Program's goals, all of the challenges and barriers identified within this MYPP need to be addressed. However, the issues identified in Figure B are critical and will be emphasized within the Program's efforts over the next five years:

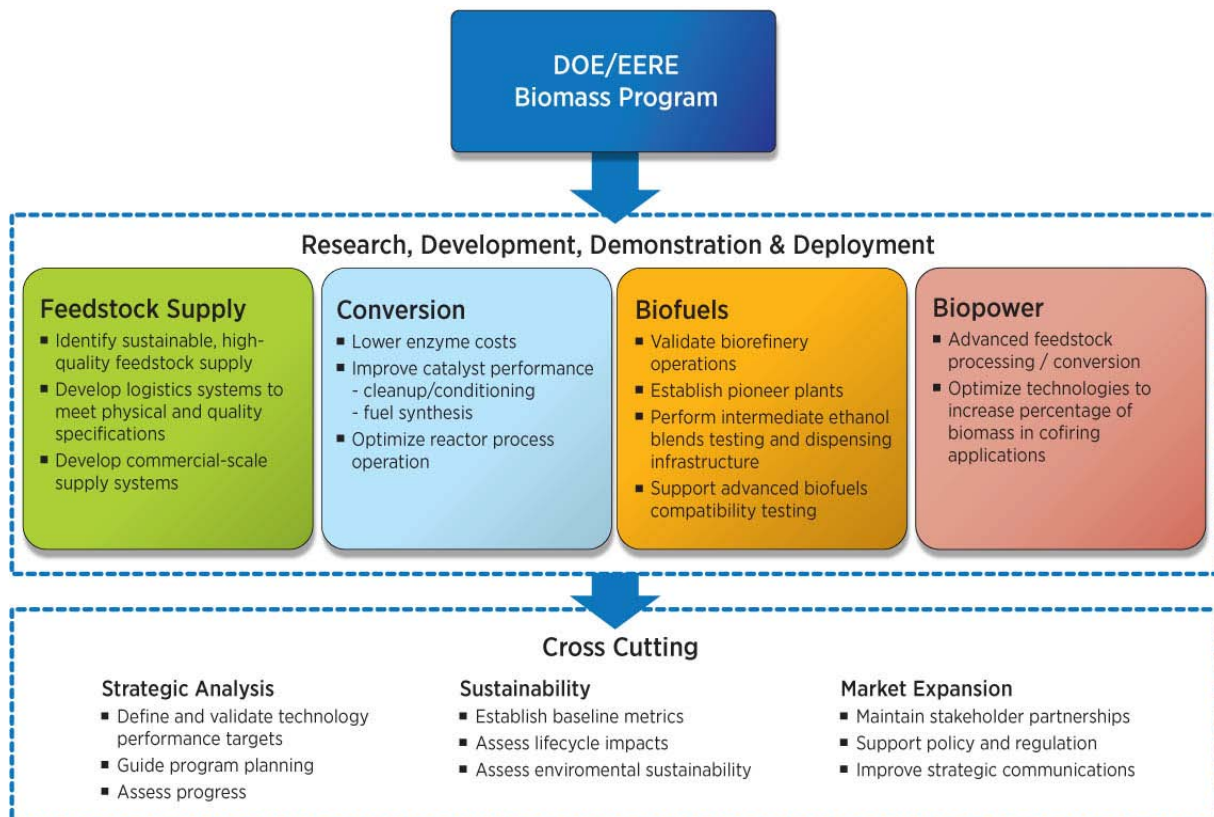

Figure B: Program Structure with High Impact Research Areas

Figure C illustrates the near-term technology development timeline and key activities of the Program. In the longer term, the Program will continue to support basic science and RDD&D of advanced biomass utilization technologies. Detailed lifecycle analysis of environmental, economic, and social impacts, while not specifically detailed as milestones, will continue to inform decisions regarding Program activities.

This approach ensures development of required technological foundation, leaves room for pursuing solutions to technical barriers as they emerge, enables demonstration activities that are critical to proof of performance, and lays the groundwork for future commercial deployment without competing with or duplicating work in the private sector. The plan addresses important technological advances to produce biofuels, as well as the underlying infrastructure needed to ensure that feedstocks are available and products can be distributed safely with the quality and performance demanded by end consumers.

The Biomass Program’s MYPP is designed to allow the Program to progressively enable the deployment of increasing amounts of biofuels, bioproducts, and biopower across the nation from a widening array of feedstocks. This approach will not only have a significant impact on oil displacement at the earliest, but will also facilitate the shift to renewable, sustainable bioenergy technologies in the long term.

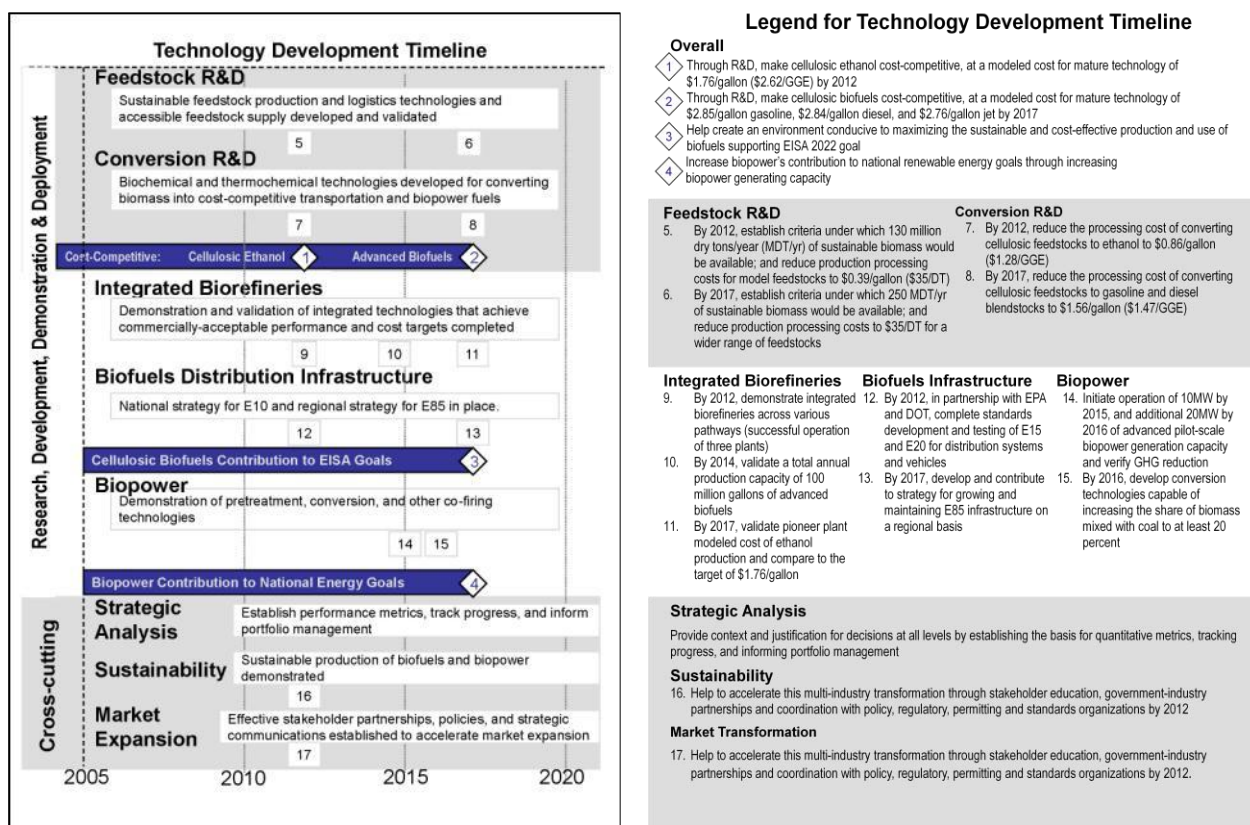

Figure C: Biomass Program Strategy and Timeline for Technology Development

Contents

Section 1: Program Overview	1-1
1.1 Market Overview and Federal Role of the Program	1-4
1.1.1 Current and Potential Markets	1-4
1.1.2 State, Local, and International Political Climate	1-7
1.1.3 Competing Alternative Fuel Technologies	1-9
1.1.4 Market Barriers	1-9
1.1.5 History of Public Efforts in Biomass RDD&D	1-10
1.1.6 Biomass Program Justification	1-11
1.2 Program Vision and Mission	1-12
1.3 Program Design	1-13
1.3.1 Program Structure	1-13
1.3.2 Program Logic	1-14
1.3.3 Relationship to Other Federal Programs	1-15
1.4 Program Goals and Multiyear Targets	1-18
1.4.1 Program Strategic Goals	1-18
1.4.2 Program Performance Goals	1-19
1.4.3 Program Multi-Year Targets	1-20
Endnotes	1-24
Section 2: Program Technology Research, Development, Demonstration, & Deployment Plan	2-1
2.1 Feedstock Supply Research and Development	2-8
2.1.1 Feedstock Support of Biomass Program Strategic Goals	2-9
2.1.2 Feedstock Support of Biomass Program Performance Goals	2-9
2.1.3 Feedstock Technical Challenges and Barriers	2-10
2.1.4 Feedstock Supply R&D Approach for Overcoming Challenges and Barriers	2-12
2.1.5 Prioritizing Feedstocks Supply R&D Barriers	2-16
2.1.6 Feedstock Platform Milestones and Decision Points	2-18
2.2 Conversion Research and Development	2-21
2.2.1 Biochemical Conversion Research and Development	2-21
2.2.1.1 Biochemical Conversion R&D Support of Program Strategic Goals	2-24
2.2.1.2 Biochemical Conversion R&D Support of Program Performance Goals	2-24
2.2.1.3 Biochemical Conversion Technical Challenges and Barriers	2-24
2.2.1.4 Biochemical Conversion R&D Approach for Overcoming Challenges and Barriers	2-26
2.2.1.5 Prioritizing Biochemical Conversion Barriers	2-30
2.2.1.6 Biochemical Conversion R&D Milestones and Decision Points	2-31
2.2.2 Thermochemical Conversion Research & Development	2-34
2.2.2.1 Thermochemical Conversion R&D Support of Program Strategic Goals	2-37
2.2.2.2 Thermochemical Conversion R&D Support of Program Performance Goals	2-37
2.2.2.3 Thermochemical Conversion R&D Technical Challenges and Barriers	2-38
2.2.2.4 Thermochemical Conversion R&D Approach for Overcoming Challenges and Barriers	2-39
2.2.2.5 Prioritizing Thermochemical Conversion R&D Focus	2-43
2.2.2.6 Thermochemical Conversion R&D Milestones and Decision Points	2-45
2.3 Integrated Biorefineries	2-49
2.3.1 Integrated Biorefineries Support of Program Strategic Goals	2-52
2.3.2 Integrated Biorefineries Support of Program Performance Goals	2-54

2.3.3	Integrated Biorefineries Challenges and Barriers.....	2-55
2.3.4	Integrated Biorefineries Approach for Overcoming Challenges and Barriers	2-57
2.3.5	Prioritizing Integrated Biorefinery Barriers.....	2-61
2.3.6	Integrated Biorefinery Milestones and Decision Points	2-61
2.4	Biofuels Distribution Infrastructure and End Use	2-65
2.4.1	Biofuels Distribution Infrastructure and End Use R&D Support of Program Strategic Goals	2-67
2.4.2	Biofuels Distribution Infrastructure and End Use R&D Support of Program Performance Goals.....	2-67
2.4.3	Biofuels Distribution Infrastructure Challenges and Barriers.....	2-67
2.4.4	Biofuels Infrastructure Approach for Overcoming Challenges and Barriers.....	2-70
2.4.5	Prioritizing Infrastructure Barriers and Activities.....	2-73
2.4.6	Biofuels Distribution Infrastructure and End Use Milestones and Decision Points	2-73
2.5	Biopower	2-76
2.5.1	Biopower Support of Program Strategic Goals	2-79
2.5.2	Biopower Support of Program Performance Goals	2-80
2.5.3	Biopower Challenges and Barriers	2-80
2.5.4	Biopower Approach for Overcoming Challenges and Barriers.....	2-82
2.5.5	Prioritizing Biopower Focus	2-84
2.6	Sustainability	2-87
2.6.1	Sustainability Support of Biomass Program Strategic Goals	2-90
2.6.2	Sustainability Support of Program Goals.....	2-90
2.6.3	Sustainability Technical Challenges and Barriers	2-91
2.6.4	Sustainability Approach for Overcoming Challenges and Barriers	2-92
2.6.5	Prioritizing Sustainability Barriers	2-94
2.6.6	Sustainability Milestones and Decision Points	2-95
2.7	Strategic Analysis.....	2-98
2.7.1	Strategic Analysis Support of Program Strategic Goals.....	2-98
2.7.2	Strategic Analysis Support of Program Performance Goals	2-99
2.7.3	Strategic Analysis Challenges and Barriers	2-99
2.7.4	Approach for Overcoming Challenges and Barriers.....	2-99
2.8	Bioenergy Market Expansion	2-106
2.8.1	Bioenergy Market Expansion Support of Program Strategic Goals	2-107
2.8.2	Bioenergy Market Expansion Support of Program Performance Goals.....	2-107
2.8.3	Bioenergy Market Expansion Challenges and Barriers.....	2-108
2.8.4	Approach for Overcoming Bioenergy Market Expansion Challenges and Barriers	2-108
	Endnotes.....	2-112
	Section 3: Program Portfolio Management.....	3-1
3.1	Program Portfolio Management Process	3-2
3.2	Program Analysis	3-5
	Endnotes.....	3-11
	Appendix A: Biomass Program Structure	A-1
	Appendix B: Technical Projection Tables	B-1
	Appendix C: Calculation Methodology for Cost Targets	C-1

Section 1: Program Overview

Growing concerns over national energy security and climate change have renewed the urgency for developing sustainable biofuels, bioproducts, and biopower. Biomass utilization for fuels, products, and power is recognized as a critical component in the nation's strategic plan to address our continued and growing dependence on imported oil. The U.S. dependence on imported oil exposes the country to critical disruptions in fuel supply, creates economic and social uncertainties for businesses and individuals, and impacts our national security.

Biomass is the only renewable resource that can supplant petroleum-based liquid transportation fuels in the near term. The United States has over a billion tons¹ of sustainable biomass resources that can provide fuel for cars, trucks, and jets; make chemicals; and produce power to supply the grid, while creating new economic opportunities and jobs throughout the country in agriculture, manufacturing, and service sectors.

The 2007 Energy Independence and Security Act (EISA) sets aggressive goals for moving biofuels into the marketplace to reduce the nation's dependence on foreign sources of energy and reduce greenhouse gas emissions from the transportation sector by increasing the supply of renewable transportation fuels to 36 billion gallons by 2022.²

To support these goals, the Biomass Program (the Program), within the Department of Energy's Office of Energy Efficiency and Renewable Energy (EERE), is focused on forming cost-share partnerships with key stakeholders to develop, demonstrate, and deploy technologies for advanced biofuels production from lignocellulosic and algal biomass.

Biomass

Biomass includes agricultural residues, forest resources, perennial grasses, woody energy crops, wastes (municipal solid waste, urban wood waste, and food waste), and algae. It is unique among renewable energy resources in that it can be converted to carbon-based fuels and chemicals, in addition to power.

Scope of Effort / Framework for Success

Meeting these goals requires significant and rapid advances in the entire biomass-to-bioenergy supply chain – from the farmer's field to the consumer (see Figure 1-1).

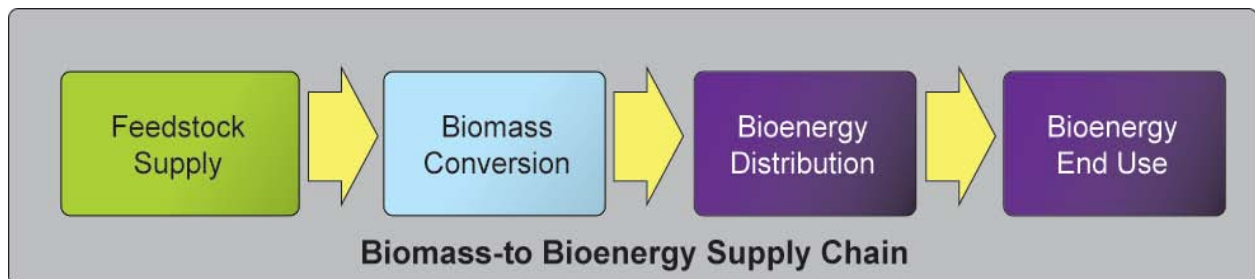

Figure 1-1: Biomass-to-Bioenergy Supply Chain

Each element of the supply chain must be engaged as summarized below:

- **Feedstock Supply:** Produce large, sustainable supplies of regionally available biomass and implement cost-effective biomass feedstock infrastructure, equipment, and systems for biomass harvesting, collection, storage, preprocessing, and transportation.
- **Bioenergy Production:** Develop and deploy cost-effective, integrated biomass conversion technologies for the production of biofuels, bioproducts, and biopower.
- **Bioenergy Distribution:** Implement biofuels distribution infrastructure (storage, blending, transportation – both before and after blending, and dispensing).
- **Bioenergy End Use:** Assess impact of fuel blends on end-user vehicles.

This breadth of scope requires the participation of a broad range of public and private stakeholders, including the general public, the scientific/research community, trade and professional associations, environmental organizations, the investment and financial community, existing industries, and government policy and regulating organizations. These stakeholders possess valuable insights and perspectives that can help identify the most critical challenges and better define strategies for effectively deploying biofuels. The framework for success also requires extensive coordination and collaboration across multiple federal stakeholder agencies.

Biomass Program's Framework for RDD&D

The Biomass Program uses an integrated framework to manage its research, development, demonstration and deployment (RDD&D) activities. The Program down-selects the most promising opportunities through systematic investigation and evaluation of a broad range of emerging technologies across several technology readiness levels (TRLs defined in Table 1-1). This approach supports a diverse technology portfolio in applied research and development, and identifies the most promising targets for follow-on industrial-scale demonstration and deployment.

The Program implements this framework through a series of Resource Loaded Plans (RLPs) developed around two broad categories of effort: RDD&D and Crosscutting Activities. The RLP process takes a rigorous approach in identifying the critical path activities and resources required to advance selected technologies through the stage-gate hierarchy of TRLs in the RDD&D pipeline.

This approach has several distinct advantages:

- It ensures the Program will examine diverse feedstocks and conversion technologies for producing biofuels, bioproducts and biopower.
- It effectively links resources with the stages of technology readiness, from applied research through commercial deployment.
- The RLP process identifies gaps within the portfolio as well as crucial linkages across RDD&D stages.
- It is adequately flexible to accommodate new ideas and approaches, as well as various combinations of feedstock and process in real biorefineries.

- It incorporates a stage-gate process which guarantees a series of periodic technology readiness reviews to help inform the down-selection process.

Table 1-1: DOE Technology Readiness Levels (TRLs)

TRL 1	<u>Basic principles observed and reported.</u> This is lowest level of technology readiness. Scientific research begins with a systematic study directed toward greater knowledge or understanding of the fundamental aspects of phenomena and of observable facts without specific applications or products in mind. The knowledge or understanding will later be translated into applied research and development. Example might include studies of a technology's basic properties.
TRL 2	<u>Technology concept and/or application formulated invention begins.</u> Once basic principles are observed, practical applications can be invented. Applications are speculative and there may be no proof or detailed analysis to support the assumptions.
TRL 3	<u>Analytical and experimental critical function and/or characteristic proof of concept.</u> Active research and development is initiated. This includes analytical studies and laboratory studies to physically validate analytical predictions of separate elements of the technology. Examples include components that are not yet integrated or representative.
TRL 4	<u>Component and/or breadboard validation in laboratory environment.</u> Basic technological components are integrated to establish that they will work together. This is relatively "low fidelity" compared to the eventual system. Examples include integration of "ad hoc" hardware in the laboratory.
TRL 5	<u>Component and/or breadboard validation in relevant environment.</u> Fidelity of breadboard technology increases significantly. The basic technological components are integrated with reasonably realistic supporting elements so it can be tested in a simulated environment. Examples include "high fidelity" laboratory integration of components.
TRL 6	<u>System/subsystem model or prototype demonstration in a relevant environment.</u> Representative model or prototype system, which is well beyond that of TRL-5, is tested in a relevant environment. This represents a major step up in a technology's demonstrated readiness. Examples include testing a prototype in a high-fidelity laboratory environment or in simulated operational environment.
TRL 7	<u>System prototype demonstration in a operational environment.</u> This represents a major step up from TRL-6. It requires the demonstration of an actual system prototype in an operational environment, such as in a light duty vehicle on the road. Examples include testing a prototype battery in an operational hybrid gas-electric vehicle.
TRL 8	<u>Actual system completed and qualified through test and Demonstration.</u> Technology has been proven to work in its final form and under expected conditions. In almost all cases, this RL-8 represents the end of true system development. Examples include developmental test and evaluation of the system in its intended parent system to determine if it meets design specifications.
TRL 9	<u>Actual system proven through successful mission operations.</u> The technology is applied and operated in its final form and under real life conditions, such as those encountered in operational test and evaluation. In almost all cases, this is the end of the last "bug fixing" aspects of true system development. Examples include using the system under various real life conditions.

Expanded Program Focus on Advanced Biofuels

While the overall mission of the Biomass Program is focused on developing advanced technologies for the production of fuels, products, and power from biomass, the Program’s near-term goals are focused on the conversion of biomass into liquid transportation fuels.

Historically, the Program’s focus has been on RDD&D for ethanol production from lignocellulosic biomass. The driving factors behind the Program’s historical focus on cellulosic ethanol are as follows:

- i) Technology Readiness
 - Over the last two decades, DOE-funded R&D has led to significant progress in the biochemical processes used to convert cellulosic biomass to ethanol. First generation technology for cellulosic ethanol production is now in the demonstration phase.

- DOE-funded R&D in this area has led to a well-developed body of work regarding the performance of ethanol as both a low-volume percentage (E10) gasoline blend in conventional vehicles and at higher blends (E85) in flexible-fuel vehicles (FFVs).

ii) Market Acceptance

- Starch-based ethanol is a well-established commodity fuel with wide market acceptance. Continued success and growth of the ethanol industry can help pave the way for the future introduction of cellulosic ethanol into the marketplace.
- FFV technology is commercially available from a number of U.S. automakers, and several have plans to significantly increase FFV production volumes and expand FFV marketing efforts in the coming years.

iii) Policy Factors

- Federal legislation predominantly focused on cellulosic ethanol production as a “second generation” biofuel to displace imported petroleum-based transportation fuels with domestic renewable fuels.

More recent national and DOE goals require the Program to expand its scope to include the development of other advanced biofuels that will contribute to the volumetric requirements of the Renewable Fuels Standard (RFS). This includes biofuels such as biobutanol, hydrocarbons from algae, and biomass-based hydrocarbon fuels (renewable gasoline, diesel, jet fuel).

Thus, while the Program’s short-term objectives include demonstrating commercially viable cellulosic ethanol production, the investments the Program has made in technologies that can reduce the recalcitrance of lignocellulosic biomass will be leveraged toward the development of third generation advanced biofuels, bioproducts, and bioenergy.

1.1 Market Overview and Federal Role of the Program

Markets for biofuels, bioproducts, and bioenergy exist today both in the United States and around the world, yet the untapped potential is enormous. Industry growth is currently constrained by limited infrastructure, high production costs, competing energy technologies, and other market barriers. Market incentives and legislative mandates are helping to overcome some of these barriers.

1.1.1 Current and Potential Markets

Major end-use markets for biomass-derived products include transportation fuels, products, and power. Today, biomass is used as a feedstock in all three categories but the contribution is small compared to oil and other fossil-based products. Most bio-derived products are now produced in facilities dedicated to a single primary product, such as ethanol, biodiesel, plastics, paper, or power (corn wet mills are an exception). The primary feedstock sources for these facilities are conventional grains, plant oils, and wood.

To meet national goals for increased production of renewable fuels, products, and power from biomass, a more diverse feedstock resource base is required – one that includes biomass from

agricultural and forest residues, and dedicated energy crops. Ultimately the industry is expected to move toward large biorefineries that produce a portfolio of biofuels and bioproducts, with integrated, onsite cogeneration of heat and power.

Transportation Fuels: America’s transportation sector relies almost exclusively on refined petroleum products, accounting for over 70% of the oil used. Oil accounts for 94% of transportation fuel use, with biofuels, natural gas, and electricity accounting for the balance.³ Nearly 9 million barrels of oil are required every day to fuel the 247 million vehicles that constitute the U.S. light-duty transportation fleet.

Biomass is a direct, near-term alternative to oil for supplying liquid transportation fuels to the nation. In the United States, nearly all gasoline is now blended with ethanol up to 10% by volume, and cars produced since the late 1970s can run on E10. U.S. automakers have committed to increase their production of FFVs that can use E85 (blends of gasoline and ethanol up to 85%) to 50% of yearly production by 2012.

High world oil prices, supportive government policies, growing environmental and energy security concerns, and the availability of low-cost corn and plant oil feedstocks have provided

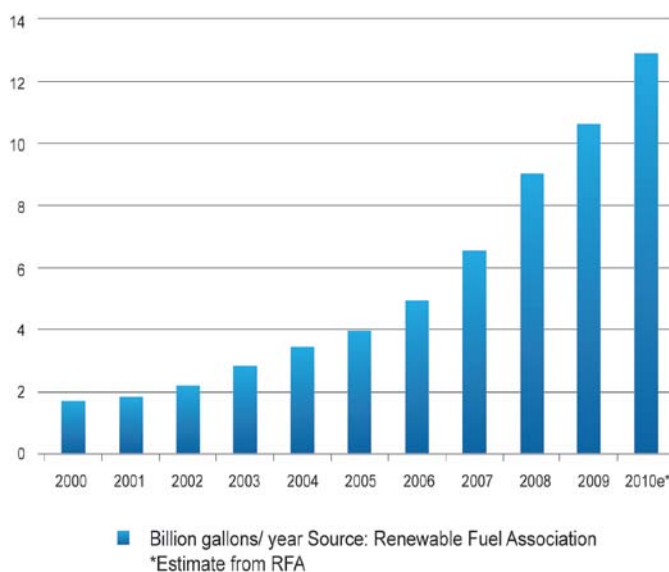

favorable market conditions for biofuels in recent years. Ethanol, in particular, has been buoyed by the need to replace the octane and clean-burning properties of MTBE, which has been removed from gasoline because of groundwater contamination concerns. As shown in Figure 1-2, current domestic production of ethanol from grains has increased rapidly over the past five years, from under 4 billion gallons per year to nearly 13 billion gallons in 2010.

Figure 1-2: U.S. Ethanol Production Capacity

Over the last few years, commodity prices have fluctuated dramatically, creating market risks for biofuel producers and the supply chain. The national RFS legislated by EISA 2007 provides a reliable market for biofuels of 15.2 billion gallons by 2012. Blender’s tax credits for ethanol and

biodiesel have helped to ensure biofuels can compete with gasoline. Historically, when the blender’s tax credit is subtracted from wholesale prices, biofuels are price competitive with petroleum fuels on a volumetric basis.⁴

To successfully penetrate the target market, however, the minimum profitable cellulosic ethanol price must be cost competitive with corn ethanol and low enough to compete with gasoline. A minimum profitable ethanol selling price of \$2.50/GGE (gallon gasoline equivalent) can compete on an energy-adjusted basis with gasoline derived from oil costing \$75 to \$80/barrel. Given the broad range of oil prices projected by the Energy Information Administration (EIA) in 2017 (\$51

to \$156/bbl),⁵ cellulosic technology may continue to require policy support and regulatory mandates.

Limited rail and truck capacity has complicated the delivery of ethanol, contributing to regional ethanol supply shortages and price spikes. Feedstock and product transportation costs remain problematic for the biofuel industry and have led many biofuel producers to locate near a dedicated feedstock supply or large demand center to minimize transportation costs.

Retail distribution also continues to be an issue. Although E10 is ubiquitous across the United States, a limited number of fueling stations for biodiesel and E85 exist. In 2009, less than 2% of fueling stations were equipped for dispensing these fuels.⁶ Some retail station owners are hesitant to offer higher percentage blends because the unique physical properties of the blends may require costly retrofits to storage and dispensing equipment. Independent station owners may also be uncomfortable with the market risk associated with novel biofuels and are reluctant to install new infrastructure.

Consumer attitudes about fuel prices and performance, biofuel-capable vehicles, and the environment also affect demand for biofuels. Consumers who are generally unfamiliar with biofuels have been hesitant to use them, even where they are available.

Products: Approximately 10% of U.S. crude oil imports are used to make chemicals and products such as plastics for industrial and consumer goods.⁷ Many products derived from petrochemicals could be replaced with biomass-derived materials. Less than 4% of U.S. chemical sales are biobased.⁸ Organic chemicals such as plastics, solvents, and alcohols represent the largest and most direct market for bioproducts.⁹ The market for specialty chemicals is much smaller but is projected to double in 15 years¹⁰ and offers opportunities for high-value bioproducts. These higher-value products could be used to increase the product slate and profitability of large integrated biorefineries. The price of bioproducts remains relatively high compared to petroleum-based products largely due to the high cost of converting biomass to chemicals and materials.

As the price of oil has increased, so has U.S. chemical manufacturers' interests in biomass-derived plastics and chemicals. Some traditional chemical companies are forming alliances with food processors and other firms to develop new chemical products that are derived from biomass, such as natural plastics, fibers, cosmetics, liquid detergents, and a natural replacement for petroleum-based antifreeze.

Biomass-derived products will also compete with existing starch-based bioproducts such as poly lactic acid. For biomass-derived products to compete, they must be cost competitive with these existing products and address commodity markets. New biomass-derived products will also have to compete globally and will, therefore, require efficient production processes and low production costs.

Power: Less than 2% of the oil consumed in the United States is used for power generation.¹¹ Fossil fuels dominate U.S. power production and account for over 70% of generation, with coal comprising 48%, natural gas 21%, and oil 1%.¹² The balance of power is provided by nuclear

(20%) and renewable sources (9%) of which biopower accounts for 1%. New natural gas-fired, combined cycle plants are expected to increase the natural gas contribution, with coal-fired power maintaining a dominant role. Renewable energy, including biopower, is projected to have the largest increase in production capacity between 2008 and 2035.¹³

Dedicated utility-scale biomass power applications are a potential route to further reducing our reliance on fossil fuels and improving the sustainability associated with power generation. Limits to the availability of a reliable, sustainable feedstock supply as well as competing demands for biofuels to meet EISA goals may constrain the feedstock volumes available for utilization in biopower applications and may also increase feedstock costs for both applications. A near-term opportunity for reducing GHG by increasing the use of biomass for power generation is to increase the deployment of cofiring applications for biomass and biomass-derived intermediates in existing power generating facilities.

1.1.2 State, Local, and International Political Climate

State and Local Political Climate

States play a critical role in developing energy policies by regulating utility rates and the permitting of energy facilities. Over the last two decades, states have collectively implemented hundreds of policies promoting the adoption of renewable energy. To encourage alternatives to petroleum in the transportation sector, states offer financial incentives for producing alternative fuels, purchasing FFVs, and developing alternative fuels infrastructure. In some cases, states mandate the use of ethanol and/or biodiesel. Several states have also established renewable portfolio standards to promote the use of biomass in power generation.

Many states encourage biomass-based industries to stimulate local economic growth, particularly in rural communities that are facing challenges related to demographic changes, job creation, capital access, infrastructure, land use, and environment. Growth in the ethanol and biodiesel industry creates jobs through plant construction, operation, maintenance, and support. An ethanol facility producing 40 million gallons per year is estimated to expand the local economic base by \$110.2 million each year through direct spending of \$56 million and \$1.2 million in increased state and local tax receipts.¹⁴ Several states have also recently begun to develop policies to reduce greenhouse gas emissions and are looking to biomass power and biofuels applications as a means to achieve targeted reductions.

International Political Climate

Oil is expected to remain the dominant energy source for transportation worldwide through 2030, with consumption expected to increase from 86.1 million barrels per day in 2008 to 110.6 million barrels per day in 2035.¹⁵ However, the use of renewable fuels is rising. Many nations are seeking to reduce petroleum imports, boost rural economies, and improve air quality through increased use of biomass. Some countries are pursuing biofuels as a means to reduce greenhouse gas (GHG) emissions. Brazil and the United States lead the world in production of biofuels for transportation, primarily ethanol (see Figure 1-3), and several other countries have developed ethanol programs, including China, India, Canada, Thailand, Argentina, Australia, and Colombia.

As countries are developing policies to encourage bioenergy, many are also developing sustainability criteria for the bioenergy they produce and use within their countries. Both the United States and the European Union (EU) have focused on GHG reduction requirements for their fuel. The EU has also established a committee to coordinate the development of further biofuel sustainability criteria.

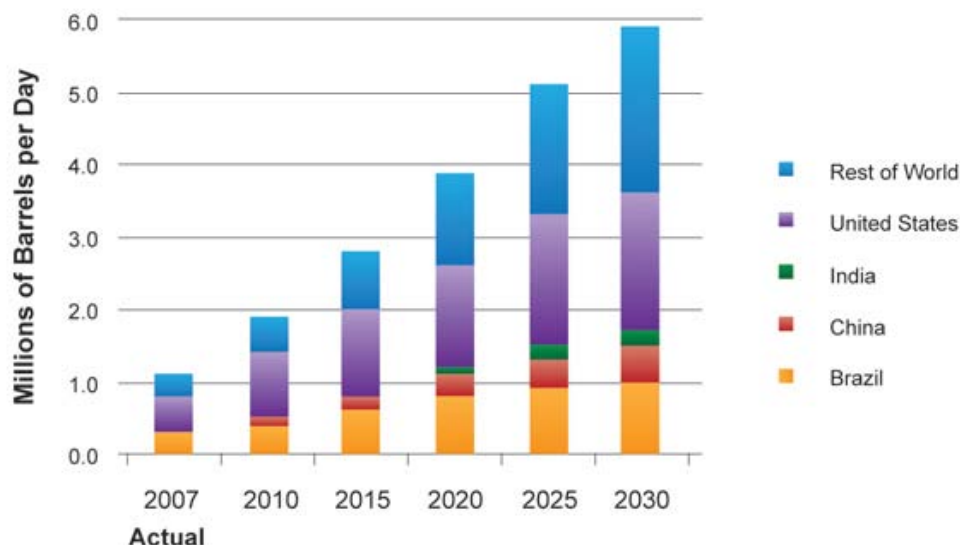

Figure 1-3: Global Production of Biofuels

Several international groups, notably the Roundtable on Sustainable Biofuels, the International Organization for Standardization, and the Global Bioenergy Partnership, are in the process of developing criteria and standards for sustainability that could be utilized in evaluation of biofuel production and processing. These criteria will address environmental, social, and economic aspects of bioenergy production.

The relationship between bioenergy, agriculture, and land use change has been the subject of increasing attention, particularly with regards to the conversion of old growth forests and native prairies into agriculture production. Policymakers, eager to address this issue, have encouraged scientists in the field of bioenergy to focus on researching the indirect impacts of bioenergy production in order to understand the magnitude of the linkage and to identify and protect any vulnerable areas valued for their role in preserving biodiversity and sequestering carbon.

In recent years, attention has focused on how the expanding production of bioenergy crops can influence international markets, potentially triggering price surges and price volatility for staple foods. Some governments have addressed this issue through discouraging the use of food-based feedstocks for bioenergy production. Recently, China halted construction of new corn-based ethanol plants and has worked to promote policies that encourage the production of biofuels from non-food feedstocks grown on marginal land. Many countries, particularly in the developing world, have identified ways by which bioenergy production can actually increase food security by generating employment, raising income in farming communities, and promoting rural development (Food and Agriculture Organization of the United Nations or UN FAO).¹⁶

1.1.3 Competing Alternative Fuel Technologies

The principal technologies that compete with biomass today rely on continued use of fossil energy sources to produce transportation fuels, products, and power in conventional petroleum refineries, petrochemical plants, and power plants. In the future, as oil demand and prices continue to rise, non-traditional technologies will likely compete with biofuels in meeting some of the transportation fuel needs of the United States. Competing technologies include:

- **Hydrogen:** Hydrogen can be produced via water electrolysis, reforming renewable liquids or natural gas; coal gasification; or nuclear synthesis routes.
- **Oil Shale-Derived Fuels:** Oil shale is a rock formation that contains large concentrations of combustible organic matter called kerogen and can yield significant quantities of shale oil. Various methods of processing oil shale to remove the oil have been developed.
- **Tar Sands-Derived Fuels:** Tar sands (also called oil sands) contain bitumen or other highly viscous forms of petroleum, which is not recoverable by conventional means. The petroleum is obtained either as raw bitumen or as a synthetic crude oil. The United States has significant tar sands resources – about 58.1 billion barrels.¹⁷
- **Coal-to-Liquids:** In terms of cost, coal-derived liquid fuels have traditionally been non-competitive with fuels derived from crude oil. As oil prices continue to rise, however, coal-derived transportation fuels may become competitive. It should be noted that conventional coal-to-liquid technologies can often be adapted to use biomass as a feedstock, both in standalone applications or blended with coal.
- **Electricity:** Electricity can be used to power electric vehicles (EVs). EVs store electricity in an energy storage device such as a battery or produce on-board power via a fuel cell, and power the vehicle's wheels via an electric motor. Plug-in hybrid electric vehicles (PHEVs) combine the benefits of pure electric vehicles and hybrid electric vehicles.

1.1.4 Market Barriers

Biorefineries using cellulosic biomass as a feedstock face market barriers at the local, state, and federal levels. Feedstock availability, production costs, investment risks, consumer awareness and acceptance, and infrastructure limitations pose significant challenges for the emerging bioenergy industry. Widespread deployment of integrated biorefineries will require demonstration of cost-effective biorefinery systems and sustainable, cost-effective feedstock supply infrastructure. The following market barriers are discussed fully in [Section 2](#):

- Feedstock Availability and Cost
- Agricultural Sector-Wide Paradigm Shift
- Cost of Production
- Higher Biofuel Delivery Costs
- High Risk of Large Capital Investments
- Inadequate Supply Chain Infrastructure
- Inconsistent or Competing Policies and Drivers to Facilitate Multi-Sector Shifts
- Insufficient or Inconsistent Regulations and Standards
- Level of Industry and Consumer Acceptance and Awareness
- Availability of Biofuels Distribution Infrastructure

- Availability of Biofuel-Compatible Vehicles
- Lack of Understanding of Environmental/Energy Tradeoffs
- Off-take Agreements
- Market Uncertainty

1.1.5 History of Public Efforts in Biomass RDD&D

Efforts in bioenergy were initiated by the National Science Foundation (NSF) and subsequently transferred to DOE in the late 1970s. Early projects focused on biofuels and biomass energy systems. In 2002, the Biomass Program was formed to consolidate the biofuels, bioproducts, and biopower research efforts across EERE into one comprehensive program. From the 1970s to the present, DOE has invested over \$3.7 billion (including more than \$900 million in ARRA funds) in a variety of RDD&D programs covering biofuels (particularly ethanol), biopower, feedstocks, municipal wastes, and a variety of biobased products. Key policy shifts, major new legislation, and EERE funding levels are shown in Figure 1-4. While steady progress has been achieved in many technical areas, considerably more progress is required to make biomass utilization technology applications competitive in the marketplace.

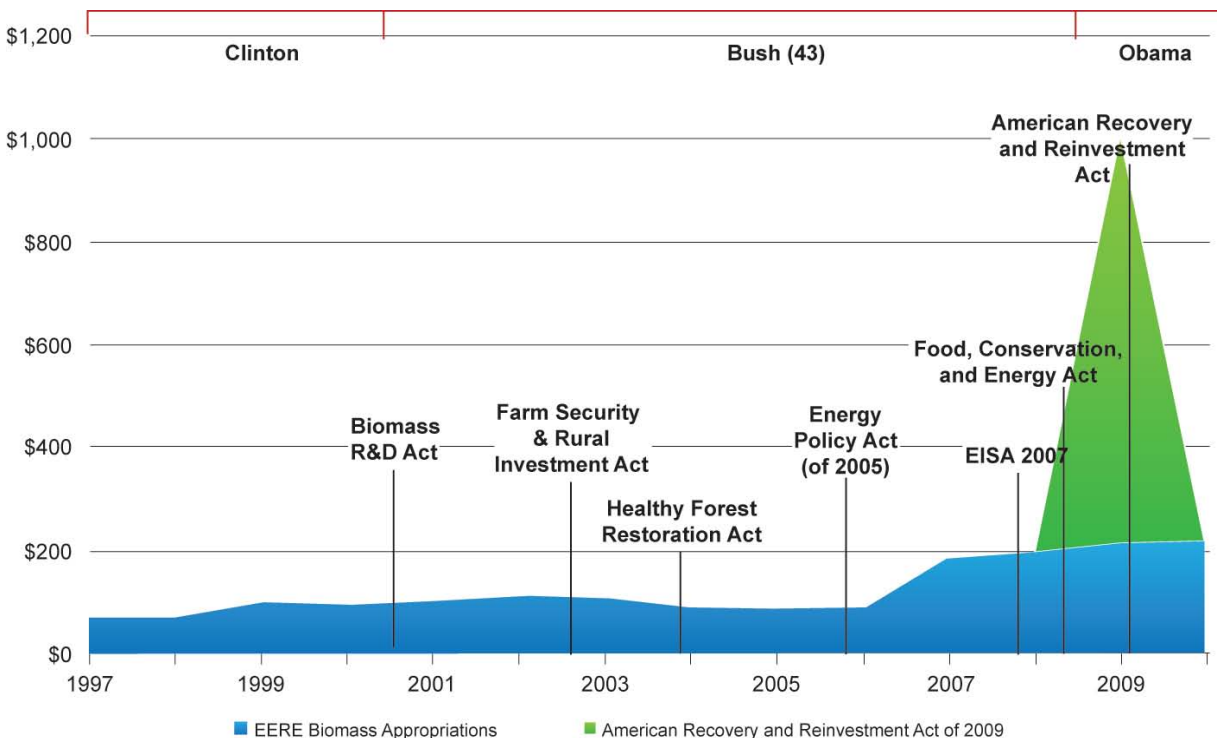

Figure 1-4: DOE EERE Funding for Biomass RDD&D

Especially in recent years, several legislative, regulatory, and policy efforts have increased the focus on increasing and accelerating biomass-related RDD&D. These efforts are summarized in Table 1-2.

Table 1-2: Legislative, regulatory, and policy efforts

May 2009	Presidential Memorandum on Biofuels	Memorandum that, among other requirements, established a Biofuels Interagency Working Group to consider policy actions to accelerate and increase biofuels production, deployment, and use. The Group is co-chaired by the Secretaries of DOE and USDA and the Administrator of EPA.
February 2009	American Reinvestment and Recovery Act (ARRA)	<ul style="list-style-type: none"> • Provided funds for grants to accelerate commercialization of advanced biofuels R&D and pilot-, demonstration-, and commercial-scale integrated biorefinery projects. • Provided funds to other DOE programs for basic R&D, innovative research, tax credits, and other projects.
May 2008	The Food, Conservation, and Energy Act of 2008 (Farm Bill)	<ul style="list-style-type: none"> • Provided grants, loans, and loan guarantees for developing and building demonstration and commercial-scale biorefineries. • Established a \$1.01 per gallon producer tax credit for cellulosic biofuels. • Established the Biomass Crop Assistance Program (BCAP) to support the production of biomass crops. • Provided support for continuation of the Biomass R&D Initiative, the Biomass R&D Board, and the Technical Advisory Committee.
December 2007	Energy Independence and Security Act (EISA) of 2007	Supported the continued development and use of biofuels, including a significantly expanded Renewable Fuels Standard, requiring 36 bgy renewable fuels by 2022 with annual requirements for advanced biofuels, cellulosic biofuels and biobased diesel.
August 2005	Energy Policy Act of 2005 (EPAAct)	Renewed and strengthened federal policies fostering ethanol production, including incentives for the production and purchase of biobased products; these diverse incentives range from authorization for demonstrations to tax credits and loan guarantees.

1.1.6 Biomass Program Justification

Between 2008 and 2035, U.S. energy consumption is projected to rise by 14% while domestic energy production by 22%. Petroleum imports, which now serve more than 54% of U.S. energy needs, are projected to decline to 44% by 2035.¹⁸ Biofuels are projected to have the largest increase in meeting domestic consumption, growing from 3.5% to over 11% of liquid fuels.¹⁹ This decreased reliance on imported energy improves our national security, economic health, and future global competitiveness. In addition, the U.S. transportation sector is responsible for one-third of U.S. carbon dioxide (CO₂) emissions, the principal GHG contributing to global warming.

Combustion of biofuels and production of biopower also releases some CO₂, but that release is largely balanced by CO₂ uptake for the plants' growth. Depending upon how much fossil energy is used to grow and process the biomass feedstock, bioenergy can substantially reduce net GHG emissions. Biomass is the only renewable energy resource that can be converted to a liquid transportation fuel, and increased use of renewable fuels provides the best near-term option for reducing GHG emissions from the transportation sector.

The overarching federal role is to ensure the availability of a reliable, affordable, and environmentally sound domestic energy supply. Billions of dollars have been spent over the last century to construct the nation's energy infrastructure for fossil fuels. The production of alternative transportation fuels from new primary energy supplies like biomass is no small undertaking. The federal role is to invest in the high-risk, high-value biomass technology RDD&D that is critical to the nation's future but that industry would not pursue independently.

States, associations, and industry will be key participants in deploying biomass technologies once risks have been sufficiently reduced by federal programs.

1.2 Program Vision and Mission

EISA 2007 aimed to increase the supply of alternative fuels and set a mandatory RFS requiring transportation fuels that are sold in the United States contain a minimum of 36 billion gallons of renewable fuels, including advanced and cellulosic biofuels and biomass-based diesel, by 2022. DOE has set a goal in its Strategic Plan to promote energy security through a diverse energy supply that is reliable, clean, and affordable.

To meet both EISA and DOE goals, the Biomass Program is focused on developing, demonstrating and deploying biofuel, bioproducts, and biopower technologies in partnership with other government agencies, industry and academia. The Program supports four key tenets of the EERE Strategic Plan (which is currently being updated):

- Dramatically reduce dependence on foreign oil
- Promote the use of diverse, domestic and sustainable energy resource
- Establish a domestic bioenergy industry
- Reduce carbon emissions from energy production and consumption

The Biomass Program's vision, mission, and goals are shown below in Figure 1-5.

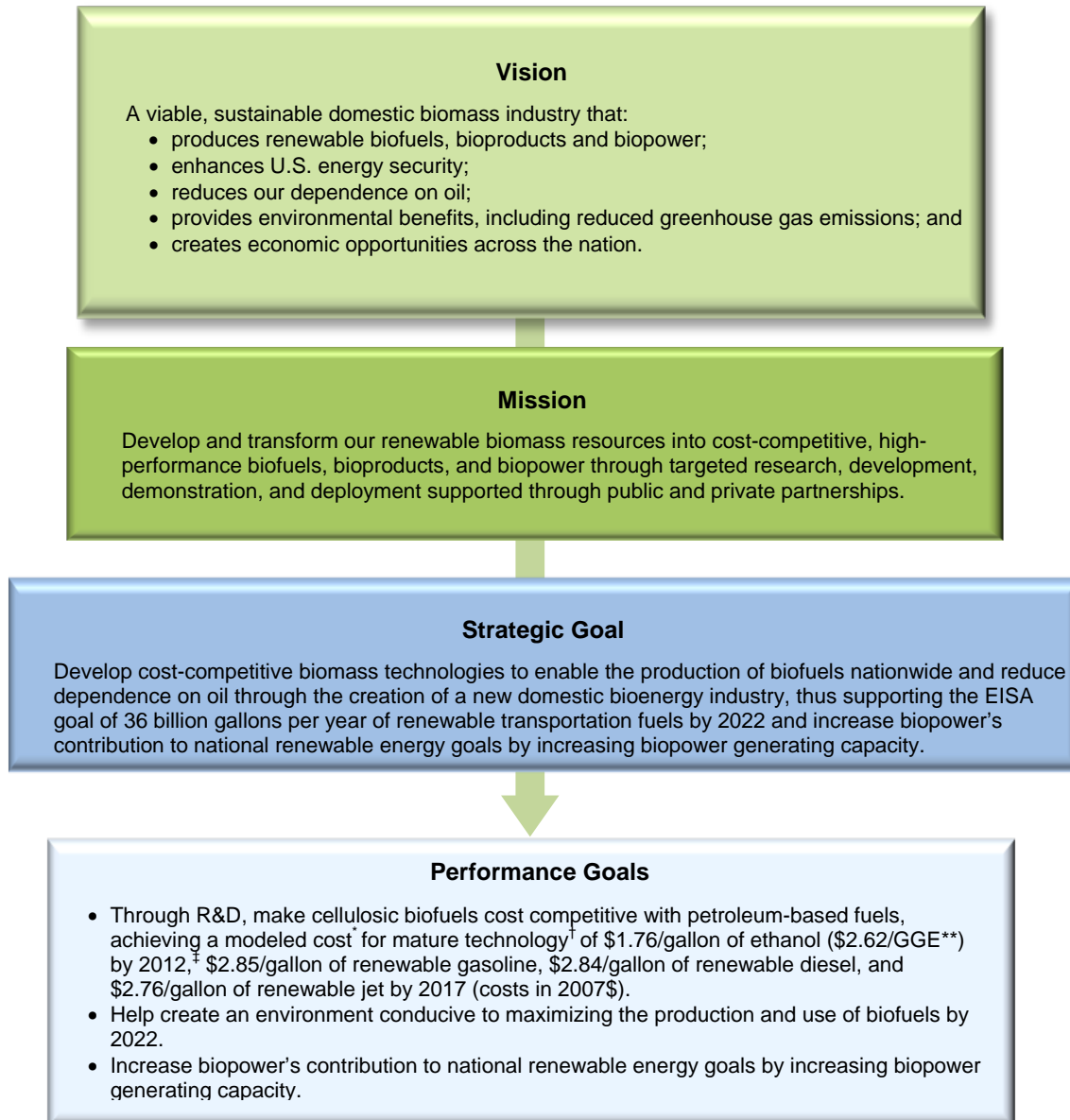

Figure 1-5: Strategic Framework for the Biomass Program

1.3 Program Design

1.3.1 Program Structure

As shown in Figure 1-6, the Biomass Program administration and work breakdown structure is organized around two broad categories of effort: Research, Development, Demonstration and Deployment, and Crosscutting Activities. The first category is comprised of four technical elements: Feedstock R&D, Conversion R&D, Biofuels, and Biopower. Cross-cutting Activities include Sustainability, Strategic Analysis, and Market Expansion.

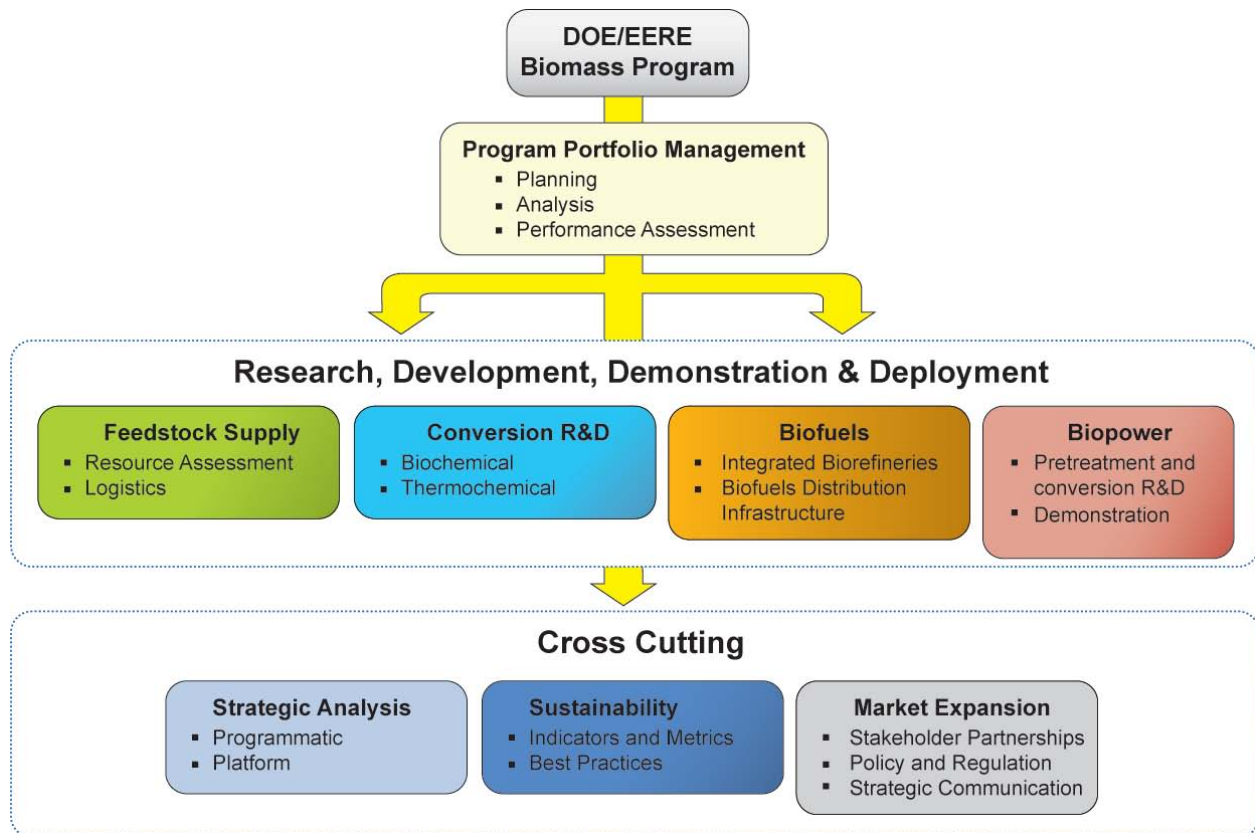

Figure 1-6: Elements of the Biomass Program

This approach provides for the development of pre-commercial, enabling technologies as well as the integration and demonstration activities critical to proof of performance. It also accommodates the sustainability, analytical, and market expansion activities needed to help the Program overcome market barriers and accelerate technology deployment.

The organization, activities, targets, and challenges of each of the Program’s four technical elements and three cross-cutting elements are described in detail in [Section 2](#).

1.3.2 Program Logic

The Program logic diagram shown in Fig. 1-7 identifies inputs that guide the Program strategy and external factors that require continuous monitoring to determine the need for any programmatic adjustments. The diagram shows Program activities and their outputs, leading to outcomes that support the Program mission and vision. This progression of linkages supports the framework for the Program strategy and this MYPP.

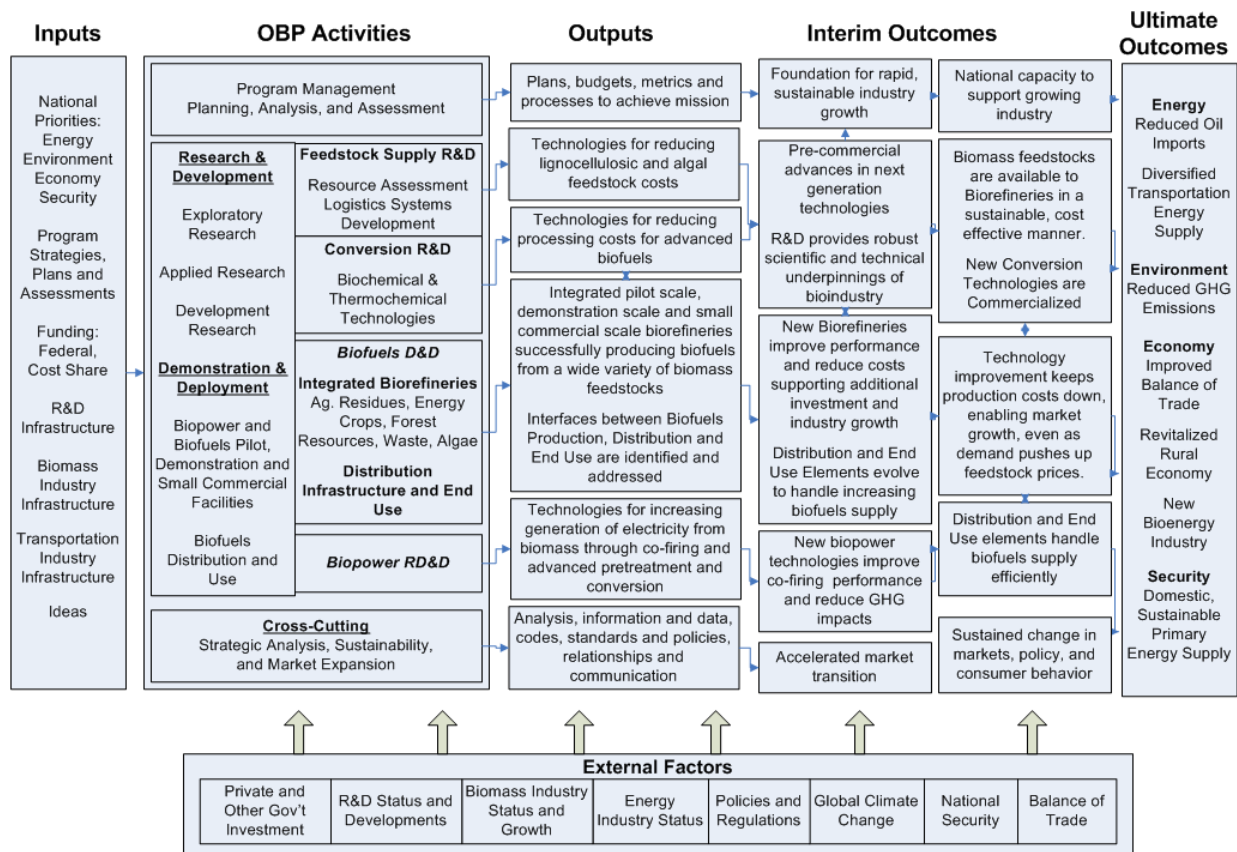

Figure 1-7: Biomass Program Logic Diagram

1.3.3 Relationship to Other Federal Programs

Coordination with other government offices involved in bioenergy is essential to avoid duplication, leverage limited resources, optimize the federal investment, ensure a consistent message to stakeholders, and meet national energy goals. As shown in Table 1-3, the Biomass Program coordinates with several other federal agencies through a range of informal and formal mechanisms.

Table 1-3: Summary of Federal Agency Roles across the Biomass-to-Bioenergy Supply Chain

Federal Agency	Feedstock Production	Feedstock Logistics	Biomass Conversion	Biorefineries and Biopower	Biofuels Distribution	Biofuels End Use
Department of Energy	Plant and algal science; genetics and breeding; feedstock resource assessment; sustainable land, crop, and forestry management	Sustainable logistics systems including harvesting, handling, storage, and pre-processing systems; testing logistics systems at demonstration scale	Biochemical conversion (pretreatment/ enzyme cost reductions); recalcitrance of all biomass resources; thermochemical conversion to fuels and power (gasification and pyrolysis)	Cost-shared projects and/or loan guarantees to (1) biorefineries, to demonstrate and deploy integrated conversion processes at pilot, demonstration, and commercial scale and (2) biopower combustion systems related to biomass as a co-firing feedstock in coal-fired boilers; demonstrations of biomass co-firing	Safe, adequate, sustainable, and cost-effective biofuels transportation/distribution systems development and deployment	Engine optimization/ certification; vehicle emissions impact; market reporting and education to improve awareness regarding impacts of biofuels
Department of Agriculture	Sustainable land, crop, and forest management; plant science; genetics and breeding; planting/ establishment payments to biomass crop producers	Sustainable harvesting of biomass crop and forest residue removal; equipment systems related to planting	Biochemical conversion (pretreatment/ enzyme cost reductions); recalcitrance of forest resources; thermo-chemical conversion to fuels and power; on-farm biofuels systems	Loan guarantees to viable commercial-scale facilities and grants to demonstration-scale facilities; payments to existing biorefineries to retrofit power sources to be renewable; producers to support and expand production of advanced biofuels refined from sources other than cornstarch	Loan guarantees and grants to (1) support safe and sustainable biofuel transportation/distribution; (2) refineries and blending facilities development; (3) flex fuel pumps installation; and (4) support financing of transportation/distribution industry/businesses	Market awareness and education to end users of advantages of increased biofuels use
Environmental Protection Agency	Effects of feedstock production systems, including affects on ecosystem services (water quality, quantity, biodiversity, etc.)		Biowaste-to-energy; air, water, waste characterization of emissions and regulations/ permitting; TSCA review of inter-generic genetically-engineered microbes used for biomass conversion; testing protocols and performance verification	Health/environmental impacts of biofuels supply chain lifecycle; air, water, waste characterization of emissions and regulations/ permitting; policy and research on waste-to-energy; testing protocols and performance verification; market impact of biofuels production	Permitting, air emission characterization; regulation of underground storage tanks; emergency management and remediation of biofuel spills	Engine optimization/ certification; characterization of vehicle emissions and air quality, environmental, and public health impacts; regulation of air emissions; market awareness/ impact of biofuels on public health, ambient air, and vehicles
Department of Commerce/ National Institute for Standards and Technology			Catalyst design, biocatalytic processing, biomass characterization, and standardization; standards development, measurement, and modeling		Materials reliability for storage containers, pipelines, and fuel delivery systems	Standard reference materials, data, and specifications for biofuels
Department of Transportation	Sustainable land, crop, and forestry management	Feedstock transport infrastructure development			Safe, adequate, cost-effective biofuels transportation/distribution systems development	Promotion of safe and efficient transportation while improving safety, economic competitiveness, and environmental sustainability
National Science Foundation	Plant genetics, algal science, and other paths to improve biofuels feedstocks and wastes as energy sources	Basic research on modifications or processes to improve feedstock preprocessing	Basic and applied research on catalysts, processes, characterization for biochemical and thermochemical conversion technologies; lifecycle analysis; environmental impact amelioration	Supportive R&D on health/environmental impacts; also, bioproducts from biorefineries		Supportive R&D on health/ environmental/safety/social issues of biofuels use
Department of the Interior	Forest management	Forest management / fire prevention (recovery of forest thinnings)	Biorefinery permitting on DOI-managed lands			
Department of Defense	Basic R&D on feedstock processing (MSW/waste biomass)		Solid waste gasification; applied algal and cellulosic feedstock research and development			Biofuels testing; Standard reference materials, data, and specifications for biofuels

Coordination among DOE Programs and Offices

Office of Science (SC): The Biomass Program regularly coordinates with SC on fundamental and applied biomass research activities and to share information about new partnerships, major research efforts, conversion- and feedstock-related activities, and possible joint funding requests.²⁰

Advanced Research Projects Agency-Energy (ARPA-E): The program coordinates with ARPA-E on biomass-related projects.

Office of Fossil Energy (FE): The Program is working with FE to develop technology improvements to increase the efficiency, environmental performance, and economic viability of utility-scale biopower applications.

Office of Energy Efficiency and Renewable Energy (EERE): The following EERE programs also contribute to one or more aspects of biomass utilization technology development:

- **Fuel Cell Technologies Program (FCT):** The production of hydrogen from biomass is pursued through two main pathways – distributed reforming of bio-derived liquids and biomass gasification. Research efforts on reformation and gasification, the availability of biomass, and renewable hydrogen as an enabler for biofuel production are coordinated between FCT and the Biomass Program. In addition, the programs collaborate on using algae to produce biofuels and hydrogen.
- **Vehicle Technologies Program (VTP):** Research on the use of non-petroleum fuels, particularly ethanol and diesel replacements, are coordinated with VTP. This coordination focuses on product distribution infrastructure and end use. The Program also interfaces with VTP’s Clean Cities Program, which develops public/private partnerships to promote alternative fuels, vehicles, and infrastructure.
- **Industrial Technologies Program (ITP):** Biomass-based technologies for gasification and the production of biobased fuels, chemicals, materials, heat, and electricity are of interest to ITP distributed energy, chemicals, and forest products subprograms.
- **Federal Energy Management Program (FEMP):** FEMP works with the federal fleet to increase the use of biopower, renewable and alternative fuels, and FFVs.
- **EERE Office of Technology Advancement and Outreach:** Program outreach efforts are supportive of and coordinated with broader corporate efforts of this Office.
- **EERE Business Administration, Planning, Budget Formulation, and Analysis (PBFA):** Program analysis activities support PBFA in carrying out EERE cross-cutting corporate analysis.

DOE Loan Guarantee Programs (LGP): The Program is actively engaged with LGP to support construction financing for first-of-a-kind integrated biorefinery facilities.*

*LGP provides loans and loan guarantees to a range of projects to spur further investments in advanced clean energy technologies.

1.4 Program Goals and Multiyear Targets

This subsection describes Biomass Program’s goals and targets.

1.4.1 Program Strategic Goals

As stated in [Section 1.2](#), the Program’s overarching strategic goals are to:

Develop cost-competitive biomass technologies to:

- *enable the production of biofuels nationwide and reduce dependence on oil through the creation of a new domestic bioenergy industry, thus supporting the EISA goal of 36 billion gallons per year of renewable transportation fuels by 2022; and*
- *increase biopower’s contribution to national renewable energy goals by increasing biopower generating capacity.*

The Program’s high-level schedule aims for cost-competitive cellulosic ethanol by 2012, cost-competitive renewable-gasoline, -diesel, and -jet by 2017, and supports EISA 2022 renewable fuels goals (Figure 1-8).

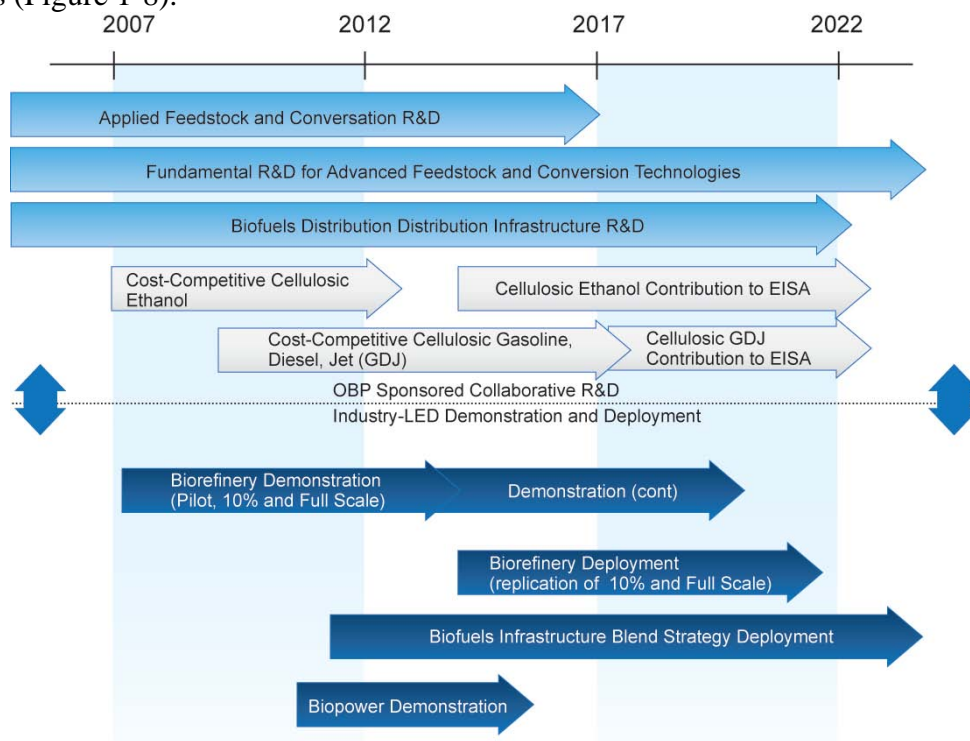

Figure 1-8: Biomass Program High-Level Schedule

The strategic goals for each program element support the overarching Biomass Program strategic goal, as shown in Figure 1-9. These goals are integrally linked – demonstration and validation activities, for example, will depend upon an available, sustainable feedstock supply, cost-effective conversion technologies, adequate distribution infrastructure, and strategic alliances and outreach to catalyze market expansion.

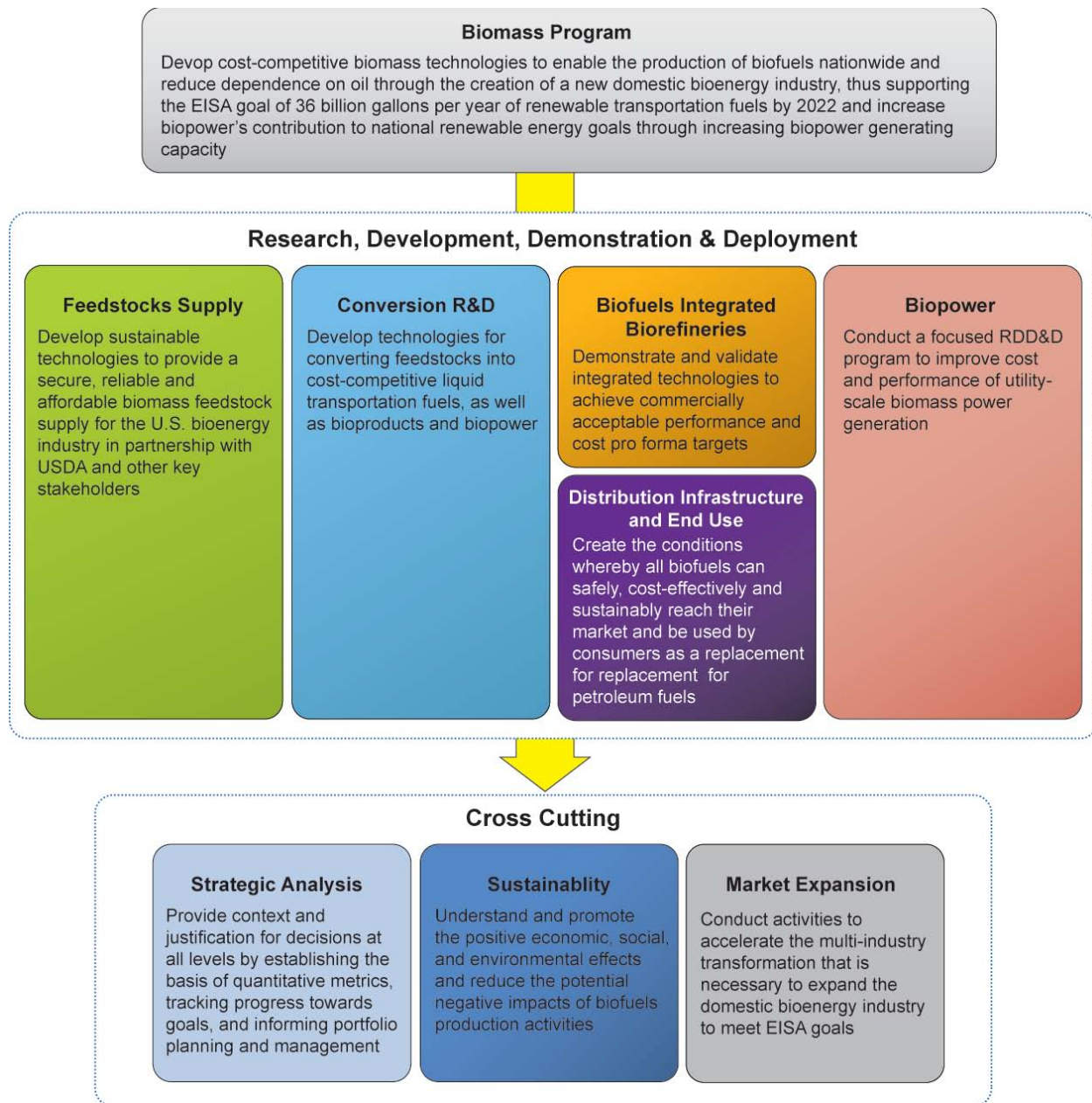

Figure 1-9: Strategic Goals for the Biomass Program

1.4.2 Program Performance Goals

The overall performance goals set for the Program are shown below. These goals reflect the near-term strategy of making cellulosic ethanol cost competitive and the mid-term strategy of making advanced cellulosic renewable gasoline, diesel, and jet cost competitive, as the most effective path for meeting EISA goals:

- Through RDD&D, make cellulosic biofuels cost competitive at a modeled* cost for mature technology* of \$1.76/gallon ethanol (\$2.62/GGE) by 2012, \$2.85/gallon of

* The modeled cost refers to the use of models to project the cost such as those defined in the NREL design reports:

- “Lignocellulosic Biomass to Ethanol Process Design and Economics Utilizing Co-Current Dilute Acid Prehydrolysis and Enzymatic Hydrolysis for Corn Stover,” NREL TP-510-32438, June 2002.

renewable gasoline, \$2.84/gallon of renewable diesel, and \$2.76/gallon of renewable jet by 2017

- Help create an environment conducive to maximizing the sustainable production and use of biofuels by 2022
- Increase biopower’s contribution to national renewable energy goals by increasing biopower generating capacity

2012 Program performance goals were established on the basis of the EIA’s 2009 projected reference wholesale gasoline price estimate in 2007 dollars.²¹ The 2017 Program performance goals were established on the basis of the EIA’s 2009 projected reference case with ARRA wholesale price estimate in 2007 dollars.²²

1.4.3 Program Multi-Year Targets

The Program’s multi-year targets for 2010 – 2017 are listed in Table 1-4, while the high-level milestones leading to these targets are listed in Table 1-5. [Section 2](#) describes in more detail the technical element performance goals and high-level milestones for all Program technical areas.

Table 1-4: Program Multi-Year Targets

Feedstock Supply R&D
<p>Resource Assessment</p> <ul style="list-style-type: none"> ▪ By 2012, establish geographic and economic criteria under which 130 million dry tons (DT) per year would be available. ▪ By 2017, establish geographic, economic, quality and environmental criteria under which 250 million DT per year would be available.
<p>Feedstock Logistics</p> <ul style="list-style-type: none"> ▪ By 2012, reduce costs for dry herbaceous feedstocks (i.e., field dried corn stover) from harvest to biochemical conversion plant gate to \$0.39 per gallon of ethanol (equivalent to approximately \$35/DT in 2007 \$). ▪ By 2017, reduce costs from harvest to biochemical conversion plant gate to \$35/DT for a wider range of herbaceous feedstocks. ▪ By 2012, reduce the logistics costs for woody feedstocks from harvest to gasification plant gate to \$0.49 per gallon of ethanol (equivalent to approximately \$35/DT in 2007 \$). ▪ By 2017, reduce the logistics costs for woody feedstocks from harvest to plant gate to \$35/DT for a wider range of woody feedstocks.
Conversion R&D
<p>Biochemical</p> <ul style="list-style-type: none"> ▪ By 2012, reduce the estimated mature technology processing cost for biochemical conversion of cellulosic feedstocks to ethanol to \$0.92 per gallon in 2012.

-
- “Thermochemical Ethanol via Indirect Gasification and Mixed Alcohol Synthesis of Lignocellulosic Biomass,” NREL/TP-510-41168, April 2007.
 - “Uniform-Format Solid Feedstock Supply System: A Commodity-Scale Design to Produce an Infrastructure-Compatible Build Solid from Lignocellulosic Biomass,” near final draft at 4/24/09.

* The ethanol production cost targets are estimated mature technology processing costs which means that the capital and operating costs are assumed to be for an “nth plant” where several plants have been built and are operating successfully so that additional costs for risk financing, longer startups, under performance, and other costs associated with pioneer plants are not included.

<p>Thermochemical</p> <ul style="list-style-type: none"> ▪ By 2012, reduce the estimated mature technology processing cost for gasification-to-ethanol to \$0.86 per gallon of ethanol (\$1.28/GGE). ▪ By 2017, reduce the estimated mature technology processing cost for a biomass-based thermochemical route that produces gasoline and diesel blendstocks to \$1.56 per gallon of total blendstock (\$1.47/GGE).
<p>Integrated Biorefineries</p> <ul style="list-style-type: none"> ▪ By 2012, demonstrate the successful operation of three integrated biorefineries across various pathways. ▪ By 2014, validate a total annual production capacity of 100 million gallons of advanced biofuels. ▪ By 2017, validate mature technology plant model for cost of ethanol production based on demonstration plant performance and compare to the target of \$1.76/gal ethanol (\$2.62/GGE).
<p>Biofuels Distribution Infrastructure and End Use R&D</p> <ul style="list-style-type: none"> ▪ By 2017, facilitate development of the infrastructure and market capacity to transport, store, and use 24 billion gallons of biofuels by 2017. ▪ By 2017, reduce the biofuels delivery cost to be competitive with the delivery costs of gasoline and diesel fuels – less than \$0.16 per gallon. ▪ By 2022, facilitate development of the infrastructure and market capacity to transport, store, and use 36 billion gallons.
<p>Biopower</p> <ul style="list-style-type: none"> ▪ By 2011, develop specifications for improved feedstock quality for materials suitable for use in advanced power generation approaches. ▪ By 2014, develop pre-treatment and conversion technologies capable of increasing the share of biomass mixed with coal to at least 20%. ▪ By 2015, initiate operation of 10 MW of advanced pilot-scale biopower generation capacity. ▪ By 2016, initiate operation of an additional 20 MW of advanced pilot-scale biopower generation capacity.
<p>Sustainability</p> <ul style="list-style-type: none"> ▪ By 2012, identify metrics and set targets for climate, water, and land-use for agricultural residues, energy crops (herbaceous and woody), and forest resources. ▪ By 2013, identify metrics and set targets for soil quality and air quality for agricultural residues, energy crops (herbaceous and woody), and forest resources. ▪ By 2017, implement best practices for a process for sustainable integrated agricultural residue to biofuel. ▪ By 2022, implement best practices for a process for sustainable integrated energy crops (herbaceous or woody) and forest resources to bioenergy.
<p>Strategic Analysis</p> <ul style="list-style-type: none"> ▪ By 2012, understand the impacts of competition for biomass resources on feedstock cost, GHG emissions, and the ability to meet the 2022 EISA goals for biofuels.

Table 1-5: Program Multi-Year Targets for 2007 – 2022

Feedstock Pathway	Agricultural Residue	Herbaceous Energy	Woody Energy	Forest Resources	Waste Processing	Algae
Research and Development						
Feedstocks						
Resource Assessment	X	X	X	X		
By 2012, identify environmental (climate, water, and land use) and feedstock quality (i.e. size, chemical composition, moisture, etc.) criteria and establish a methodology for incorporation into biomass supply assessments for agricultural residues, energy crops, and forest resources pathways.	X	X	X	X		
By 2013, identify environmental criteria (soil health and air quality) and establish a methodology for incorporation into biomass supply assessments for agricultural residues, energy crops, and forest resources pathways.	X	X	X	X		
By 2014, integrate environmental and feedstock quality criteria into biomass supply assessments for agricultural residues, energy crops, and forest resources pathways.	X	X	X	X		
By 2016, produce a fully integrated assessment of the potentially available feedstock supplies under specified criteria and conditions.	X	X	X	X		
Logistics						
By 2012, validate baseline integrated feedstock logistics systems for dry corn stover and debarkable woody forest resources at field scale.	X	X	X	X		
By 2015, validate advanced herbaceous and woody biomass preprocessing systems against conversion quality criteria.	X	X	X	X		
By 2017, validate fully integrated advanced feedstock logistics systems that accept all herbaceous and woody biomass resources at field scale.	X	X	X	X		
Conversion						
Biochemical						
By 2012, validate integrated production of ethanol from corn stover, via biochemical conversion.	X					
Thermochemical						
By 2012, validate integrated conversion process to produce ethanol from mixed alcohols via gasification of woody feedstocks at scale sufficient to enable transfer to pilot scale operation.			X	X		
By 2015, validate integrated conversion process for woody biomass to renewable-gasoline or -diesel via pyrolysis at scale sufficient to enable transfer to pilot scale operation.			X	X		
By 2017, validate fully integrated conversion process for woody biomass to renewable-gasoline or -diesel via pyrolysis at scale sufficient to enable transfer to pilot scale operation.			X	X		
By 2015, validate integrated production of biomass to gasoline or diesel via pyrolysis routes at pilot plant scale	X	X	X	X	X	
Demonstration and Deployment						
Integrated Biorefineries						
By 2012, demonstrate the successful operation of three integrated biorefineries across various pathways.	X	X	X	X	X	X
By 2014, validate a total annual production capacity of 100 million gallons of advanced biofuels.	X	X	X	X	X	X
By 2017, mature technology plant model will be validated for cost of ethanol production based on demonstration plant performance and compared to the target of \$1.76/gal EtOH (\$2.62/GGE).	X	X	X	X	X	X

Feedstock Pathway	Agricultural Residue	Herbaceous Energy	Woody Energy	Forest Resources	Waste Processing	Algae
Biofuels Distribution Infrastructure and End Use						
By 2011, existing infrastructure modes and transportation capacity for ethanol assessed and E15 testing and characterization completed.	N/A	N/A	N/A	N/A	N/A	N/A
By 2012, market end use capacity for ethanol based on E15 waiver decision determined.	N/A	N/A	N/A	N/A	N/A	N/A
By 2017, all appropriate testing and characterization for waiver applications of the most promising advanced biofuels completed.	N/A	N/A	N/A	N/A	N/A	N/A
By 2017, demonstrate and validate production of ethanol from mixed alcohols produced from energy crops (lignin- or biomass-derived) syngas at demonstration or commercial scale.	N/A	N/A	N/A	N/A	N/A	N/A
Biopower						
By 2014, develop specifications for improved feedstock quality for materials suitable for use in advanced power generation approaches.	X	X	X	X	X	
By 2015, initiate operation of 10 MW of advanced pilot-scale biopower generation capacity and verifying associated GHG reductions.	X	X	X	X	X	
By 2016, initiate operation of an additional 20 MW of advanced pilot-scale biopower generation capacity and verifying associated GHG reductions.	X	X	X	X	X	
By 2017, develop pre-treatment and conversion technologies capable of increasing the share of biomass mixed with coal to at least 20% (heat input basis).	X	X	X	X	X	
Sustainability						
Analysis						
By 2012, establish baseline and targets for all sustainability categories for the integrated biomass to biofuel process for agricultural residues, energy crops (woody or herbaceous), and forest resources.	X	X	X	X		
By 2017, evaluate and compare the sustainability of agricultural residues, energy crops, and forest resources pathways for biofuel production.	X	X	X	X		
By 2022, evaluate and compare the sustainability of biofuel production pathways.	X	X	X	X	X	X
Demonstration						
By 2015, demonstrate sustainable production of biofuel from agricultural residues at pilot scale including all sustainability categories.	X					
By 2017, demonstrate sustainable production of biofuel from woody or herbaceous energy crops at pilot scale including all sustainability categories.		X	X			
By 2022, demonstrate sustainable biofuel production from all feedstocks	X	X	X	X	X	X
Best Practices Deployment						
By 2017, implement best practices for all sustainability categories for a sustainable integrated biomass-to-biofuel process for agricultural residue.	X					
By 2022, implement best practices for all sustainability categories for a sustainable integrated biomass to bioenergy process for energy crops (woody or herbaceous) and forest resources.		X	X	X		
<p>Demonstration: At pilot scale and beyond, verify that the unit operations operate as designed and meet the complete set of performance metrics (individually and as an integrated system).</p> <p>Validation: At pilot scale and beyond, ensure the process/system meets desired expectations/original intent. Validation goes beyond just meeting all of the performance metrics; it is an assessment of whether the system actually fulfills/completes a portion of the program effort so that the Program can move on to the next priority.</p>						

Endnotes

- ¹ *Biomass as a Feedstock for a Bioenergy and Bioproducts Industry: The Technical Feasibility of a Billion-Ton Annual Supply*, Robert D. Perlack, et al., USDA/DOE, DOE/GO-102005-2135, April 2005.
- ² EISA 2007 legal reference.
- ³ Annual Energy Review 2009, Report #: DOE/EIA-0384(2009), Release Date: August 19, 2009
http://www.eia.doe.gov/aer/pecss_diagram.html
- ⁴ EIA 2007 Annual Energy Outlook.
- ⁵ EIA 2010 Annual Energy Outlook, http://www.eia.doe.gov/oiaf/aeo/excel/figure16_data.xls
- ⁶ Number of E85 stations in US: Alternative Fuels and Advanced Vehicles Data Center, Updated 8/10/2010; Number of retail gasoline stations in US: NPN Petroleum and Convenience, July/August 2010.
- ⁷ Biobased Chemicals and Products, 2010, Biotechnology Industry Organization.
- ⁸ Biobased Chemicals and Products, 2010, Biotechnology Industry Organization.
- ⁹ *Winning the Oil Endgame: Innovation for Profits, Jobs, and Security*, Amory B. Lovins, et al., Rocky Mountain Institute, 2004.
- ¹⁰ Biobased Chemicals and Products, 2010, Biotechnology Industry Organization
- ¹¹ EIA Annual Energy Review, 2010 data, <http://www.eia.doe.gov/oiaf/aeo/index.html>
- ¹² EIA Annual Energy Outlook 2010 with Projections to 2035, Report #:DOE/EIA-0383(2010), Release Date: May 11, 2010
- ¹³ Annual Energy Outlook 2010 with Projections to 2035, Report #: DOE/EIA-0383(2010), Release Date: May 11, 2010, <http://www.eia.doe.gov/oiaf/aeo/electricity.html>
- ¹⁴ RFA Ethanol Outlook 2005 <http://www.ethanolrfa.org/outlook2005.pdf>
- ¹⁵ International Energy Outlook 2009, DOE/EIA, [http://www.eia.doe.gov/oiaf/ieo/pdf/0484\(2010\).pdf](http://www.eia.doe.gov/oiaf/ieo/pdf/0484(2010).pdf)
- ¹⁶ <http://www.fao.org/bioenergy/foodsecurity/befs/en/>
- ¹⁷ World Energy Council Survey of Energy Resources 2001 <http://www.worldenergy.org/wec-geis/publications/reports/ser/bitumen/bitumen.asp>
- ¹⁸ US Department of Energy, Energy Information Agency, Annual Energy Outlook 2008 (Early Release) (March 2008 revised) DOE/EIA 0383-2008
- ¹⁹ Annual Energy Outlook 2010 with Projections to 2035, Report #:DOE/EIA-0383(2010), Release Date: May 11, 2010
- ²⁰ SC-EERE jointly developed the 2005 research roadmap “Breaking the Biological Barriers to Cellulosic Ethanol: A Joint Research Agenda”, which outlines the basic science and applied research needed to accelerate advances in cellulosic ethanol, and has helped guide multiyear technical planning.
- ²¹ EIA, “Annual Energy Outlook 2009,” Table 112, U.S.,
http://www.eia.doe.gov/oiaf/archive/aeo09/supplement/suptab_112.xls
- ²² EIA, “Annual Energy Outlook 2009 Reference Case with ARRA,” Table 112, U.S.,
http://www.eia.doe.gov/oiaf/aeo/supplement/stimulus/arra/excel/suptab_112.xls

Section 2: Program Technology Research, Development, Demonstration, & Deployment Plan

The Biomass Program’s research, development, demonstration, and deployment (RDD&D) efforts are organized around five key technical and three cross-cutting elements (Figure 2-1). The first two technical Program elements – Feedstock Supply R&D and Conversion R&D – primarily focus on research and development. The next two technical areas – Integrated Biorefineries and Distribution Infrastructure – primarily focus on demonstration and deployment. The fifth technical area, Biopower includes both R&D and demonstration activities. The cross-cutting elements – sustainability, strategic analysis, and market expansion – focus on addressing barriers that could impede adoption of biomass technologies. This organization of the work allows the Program to allocate resources for pre-commercial, enabling technology development, as well as for demonstration and deployment of technologies across the biomass-to-bioenergy supply chain.

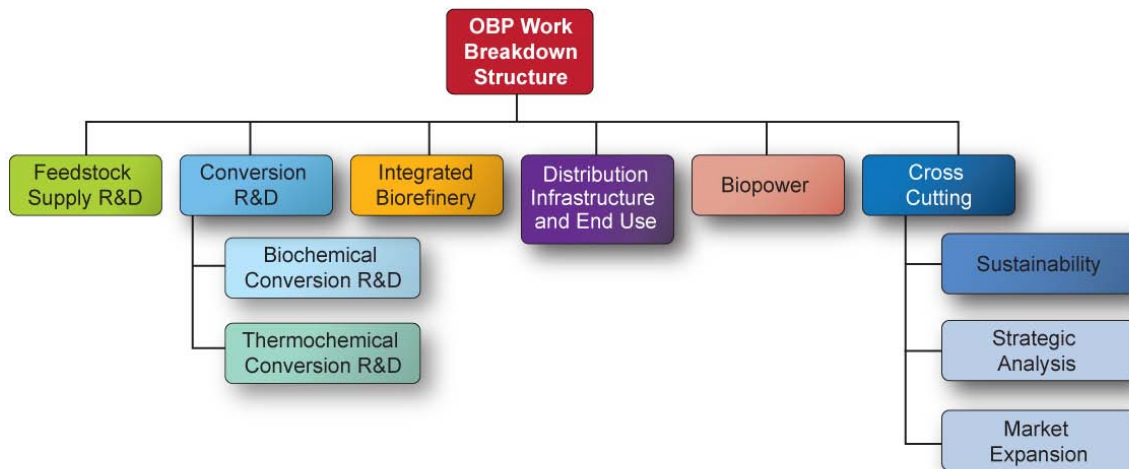

Figure 2-1: Biomass Program Work Breakdown Structure (Technical Elements Only)

Program Work Breakdown Structure

Research and Development (R&D)

The R&D activities sponsored by the Program are focused on addressing technical barriers, providing engineering solutions, and developing the scientific and engineering underpinnings of a bioenergy industry. Near- to mid-term applied R&D is focused on moving current feedstock and conversion technologies from concept to bench to integrated pilot scale. The goal of longer-term R&D is to develop basic knowledge of biomass, biological systems, and biochemical and thermochemical processes; this knowledge can ultimately be used to develop new or improved technologies that increase the conversion efficiency and/or reduce the conversion cost. Program R&D is performed by national laboratories, industry, and universities.

The Program R&D includes three technical elements:

- **Feedstock Supply R&D** is focused on developing sustainable technologies to provide a reliable, affordable, and sustainable biomass supply. This R&D is conducted in partnership with the U.S. Department of Agriculture (USDA) and DOE’s Office of

Science. The Program’s primary focus is on feedstock resource assessment, feedstock logistics, i.e., harvesting, storage and transportation, and algal feedstock supply R&D. (For details, see [Section 2.1](#))

- **Conversion R&D** is focused on developing technologies to convert feedstocks into cost-competitive liquid transportation fuels, as well as bioproducts and biopower. Biochemical conversion efforts focus on producing sugars from biomass and fermenting those sugars to fuels or chemicals. Thermochemical conversion work is focused on producing intermediates from biomass and organic biorefinery residues via gasification, pyrolysis, and other chemical means and converting these intermediates into fuels, chemicals, or power. (For details, see [Section 2.2](#))
- **Biopower R&D** is focused on developing technologies that will facilitate the use of biomass as a feedstock for power generation. Activities include the development of cost-effective feedstock pretreatment and conversion processes to improve overall power generation cycle efficiency, lower overall production costs, and reduce greenhouse gas (GHG) emissions. In addition, the Program will undertake combustion system R&D to resolve technical issues relating to biopower combustion operations and to mitigate technical challenges resulting from introducing biomass as a cofiring feedstock in coal-fired boilers. (For details, see [Section 2.5](#))

Technology Demonstration and Deployment

The Biomass Program’s demonstration and deployment activities focus on integrated biorefinery and biopower applications. The integrated biorefinery activities address the proverbial “Valley of Death” between pilot scale and commercial scale deployment, while biopower activities focus on proving cofiring at scale to enable near-term replication.

For biofuels, the goal of the demonstration and deployment activities is to develop emerging production technologies beyond bench scale to pre-commercial demonstration scale, culminating in the construction of pioneer biofuels production plants. The Program is also working to facilitate the introduction and expansion of biofuels distribution infrastructure and biofuels-compatible vehicles across the United States into the marketplace. These demonstration and deployment efforts directly align with the biomass-to-bioenergy supply chain, as illustrated in Figure 2-2.

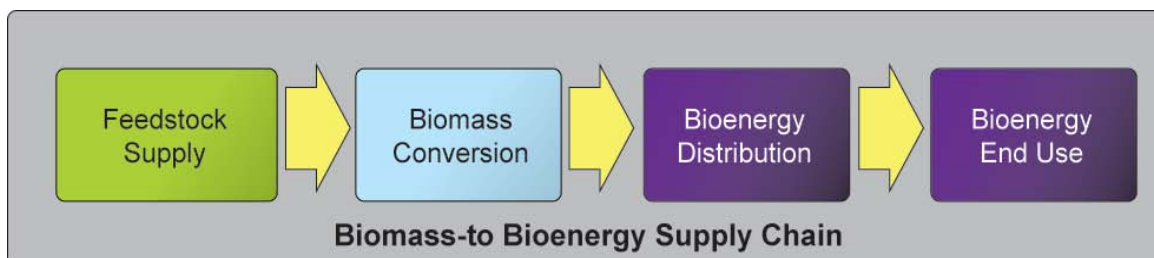

Figure 2-2: Scope of Program’s Demonstration and Deployment Efforts

The ultimate technology demonstration and deployment goal is to develop the supporting infrastructure needed to enable a fully developed and operational biomass-to-bioenergy supply chain in support of the Program’s goals. Demonstration and deployment is conducted via Program partnerships with industry and other key stakeholders and includes two technical elements:

- **Integrated Biorefinery** activities focus on demonstration and deployment of integrated conversion processes at a sufficient scale to demonstrate and validate commercially acceptable cost and performance targets. These efforts are industry-led, cost-shared, competitively awarded projects. Intellectual property and geographic and market factors will determine the feedstock and conversion technology options that industry will choose to demonstrate and commercialize. Government cost share of biorefinery development is essential due to the high technical and financial risk. The Program will fund a number of pilot-scale, demonstration-scale, and commercial-scale biofuel production facilities over the next five years (see [Section 2.3](#)).
- **Biofuels Distribution Infrastructure and End Use** activities focus on coordinating with other federal agencies to develop the required biofuels distribution and end use infrastructure. These activities include evaluating the performance and materials, environmental impacts, and health and safety impacts of intermediate ethanol blends (e.g., E15 and E20), as well as supporting growth of E85 where regionally appropriate (see [Section 2.4](#)).
- **Biopower Demonstration** activities focus on demonstrations of biomass cofiring to increase the amount of biomass used for electricity generation, as well as to increase the efficiency, environmental performance, and economic viability of biopower applications. These efforts will be industry-led, cost-shared, competitively awarded projects (see [Section 2.5](#)).

Cross-Cutting Activities

- **Sustainability** activities focus on developing the resources, technologies, and systems needed to grow a biomass energy industry in a way that protects our environment. While oil displacement is at the core of the Program’s mission, a shift beyond renewable energy to long-term sustainability is increasingly important. The existing and emerging bioenergy industry, which includes such diverse sectors as agriculture, waste management, and automobile manufacturing, will need to invest in systems based on economic viability and market needs, while also addressing the more overarching concerns such as food security and environmental sustainability. To that end, the Biomass Program is working to articulate the challenges related to sustainable bioenergy production and partnering with other agencies to address these challenges through basic and applied research and analysis (see [Section 2.6](#)).
- **Strategic Analysis** includes a broad spectrum of cross-cutting analyses to support decision making, demonstrate progress toward goals, and direct research activities. Programmatic analysis helps frame the overall program goals and priorities and covers issues that impact all technology areas, such as lifecycle assessment of GHG emissions from bioenergy. Platform-level analysis helps to monitor and check the program accomplishments in each technology area. Continued public-private partnerships with the biomass scientific community and multi-lab coordination efforts will help ensure that the analysis results from the program are transparent, transferable, and comparable (see [Section 2.7](#)).
- **Market Expansion** through the increased production and use of biofuels, biopower, and bioproducts will require fundamental changes in our economy over the next decade. Achieving program goals will require significant changes across multiple sectors and industries. Bioenergy market expansion is focused on identifying and addressing non-technical and market barriers to bioenergy adoption and use. Market expansion activities

include stakeholder partnerships and collaboration, government policy and regulation, and strategic communications (see [Section 2.8](#)).

The Program’s Biorefinery Feedstock Pathways Framework

The biorefinery feedstock pathways framework integrates efforts among the technical elements and aligns with the major bioenergy industry market segments. Figure 2-2 shows the relationship between program elements. Figure 2-3 shows the relationships between the biorefinery pathways currently supported by the Program in terms of feedstocks, conversion processes, and products. The Biomass Program’s pathways framework highlights the Program’s current priority feedstock pathways to biofuel production: Agricultural Residue Processing, Energy Crops, Forest Resources, Waste, and Algae pathways.

The Program uses the biorefinery pathway framework to identify priorities and balance the RDD&D activities that are expected to have the greatest impact on achieving Program goals. Figure 2-3 shows the Program integration of R&D and demonstration and deployment of integrated biorefineries that will use the broad range of biomass feedstocks and leverage the know-how, capabilities, and infrastructure of the existing bioenergy industry.

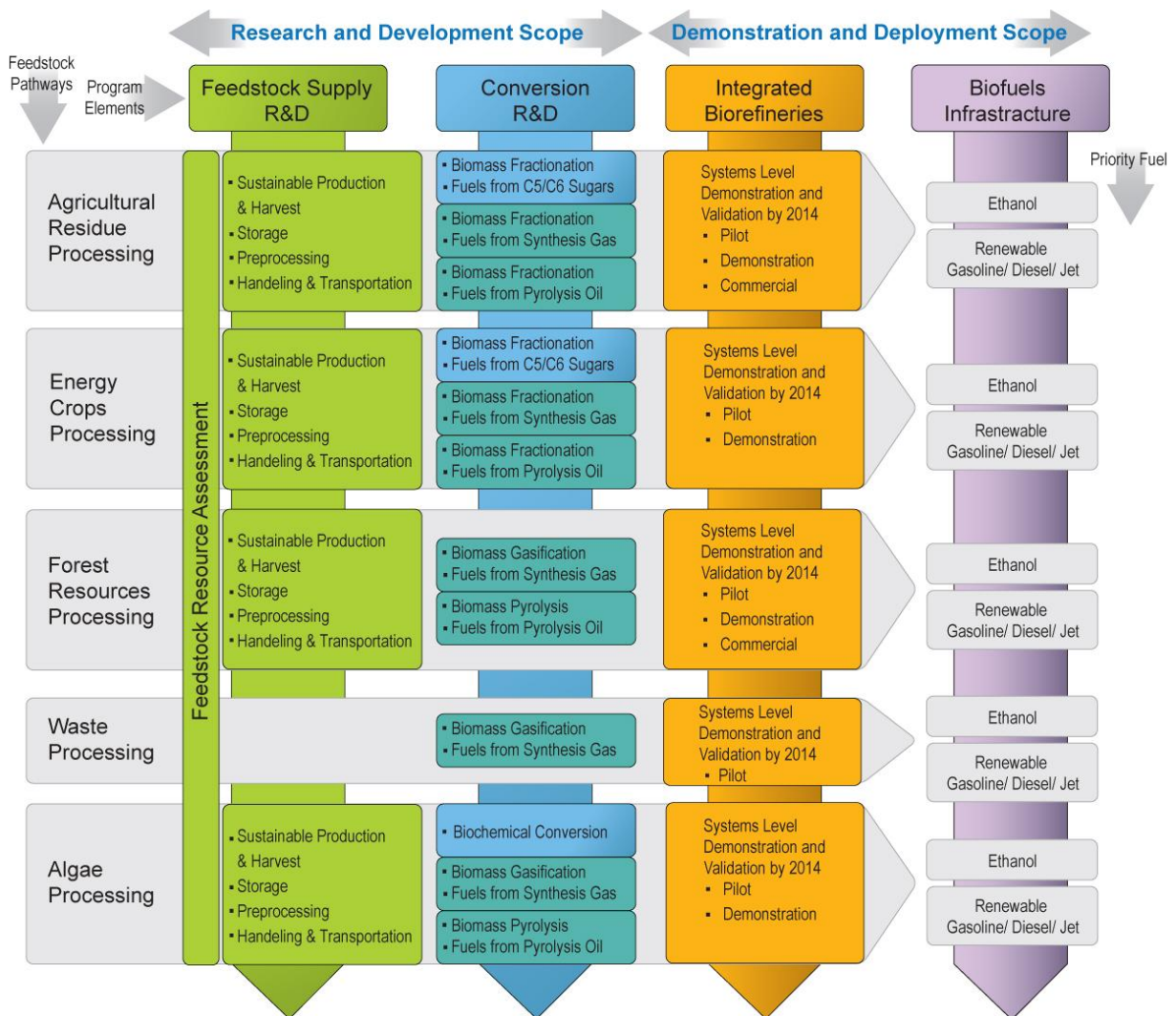

Figure 2-3: Program Technical Element Links to Biorefinery Pathway Framework

Premises for Program’s Biorefinery Feedstock Pathway Framework

The Program biorefinery feedstock pathway framework has developed over time to support the following needs:

- Recognize the diversity of feedstocks and the need to address substrate-specific issues from production through conversion
- Highlight the need for integration between the feedstock production, feedstock logistics, and conversion elements in the biomass supply chain
- Identify the complete set of technologies required up to and including those in the biorefinery, as well as the connections or interfaces between the individual technology parts, especially those from fundamentally different technical areas or disciplines
- Clarify how new technologies could fit into the existing bioenergy industry market segments (e.g., corn ethanol, pulp and paper mills)
- Identify current and future synergies within existing bioenergy industry market segments
- Envision the transition from today’s bioenergy industry to the future.

The biorefinery pathways were charted in a manner so that they would link to specific portions of the resource base identified in the *Billion Ton Study*^{*} and either:

- (1) represent existing segments of today’s bioindustry where possible, or
- (2) accommodate potential major future bioindustry market segments where envisioned.

Additionally, the pathways were designed keeping the following factors in mind:

- Specific enough to enable
 - creation of detailed RDD&D plans by giving technical context to performance metrics and cost targets
 - tracking of technological status and progress toward commercialization
- Flexible enough to be able to include new ideas and approaches as they are identified
- Generic enough so that combinations of pathways or pathway segments could be used to describe biorefineries
- Detailed enough with multiple levels of detail so that information could be rolled up or drilled down into depending on the need.

Pathway Links to the Biomass Resource Base

Linking the biorefinery pathways to a biomass resource base bounds the total bioenergy potential from each source and helps to clearly identify the necessary R&D associated with feedstock production and logistics. The resource base also guides prioritization so that the Program can focus on the feedstocks with the greatest impact on its goals.

The Billion Ton study—published in 2005 and currently being updated—described the potential biomass supply that could be generated from U.S. agricultural and forest lands, as well as secondary and tertiary residues. The majority of the types of biomass resources described in the study are included as feedstocks to one of the pathways shown in Figure 2-4. This figure shows

^{*} Joint report by USDA and DOE: *Biomass as a Feedstock for a Bioenergy and Bioproducts Industry: The Technical Feasibility of a Billion-Ton Annual Supply*, Robert D. Perlack, et al. (April 2005).

categories of feedstocks that led to pathway definitions. However, there are some portions of the biomass resource base, such as animal manures, that do not currently have corresponding pathways defined in detail. These portions do not currently represent a significant segment of the overall Program investment and are covered by other federal efforts (most notably USDA and EPA). Biomass from nonterrestrial sources, such as algae, was also not included in the Billion Ton Study. Efforts to define this potential biomass resource base are ongoing.

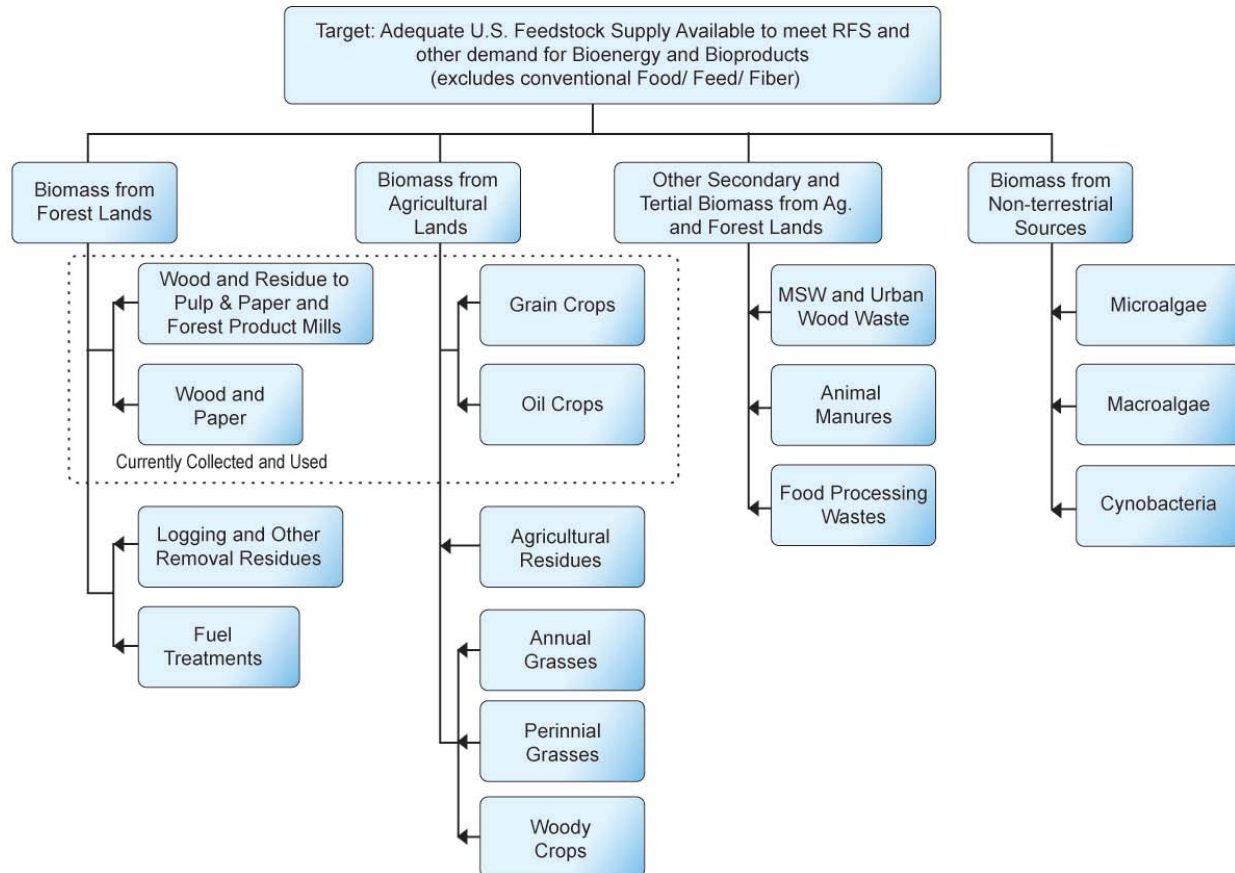

Figure 2-4: Biomass Resource Categories

Pathway Links to Bioenergy Industry Market Segments – Current and Future

The existing bioenergy industry provides opportunities for public-private partnerships to integrate and demonstrate new conversion technologies in existing commercial plants where the feedstock and infrastructure exist that could support a buildout of additional capacity (e.g., corn wet and dry grind mills, pulp and paper mills). These biorefinery pathways provide nearer-term opportunities to help achieve program goals. Efforts along these pathways serve a twofold purpose; the first benefit is the acceleration of technology deployment since the use of existing infrastructure with a readily available feedstock lowers the capital cost and associated risk. The second benefit is a reduction in the time it takes to build stand-alone plants. Integrating new technology into existing plants improves yield, efficiency, and profitability of the existing operation while increasing the likelihood of obtaining commercial financing to enable the expansion of the domestic biofuels industry.

Agricultural residue, forest resources, energy crop, and algae pathways require significant R&D in the areas of feedstock production, feedstock logistics, and conversion technologies. While development time is longer for these options, their potential impact on displacing imported oil by producing biofuels is significantly larger.

Program Element Discussion

The remainder of Section 2 details plans for each Program element:

Feedstock Supply	Section 2.1
Conversion	Section 2.2
Integrated Biorefineries	Section 2.3
Biofuels Infrastructure	Section 2.4
Biopower	Section 2.5
Sustainability	Section 2.6
Strategic Analysis	Section 2.7
Market expansion.....	Section 2.8

Each element discussion is organized as follows:

- Brief overview of the element process concept and its interfaces with other elements of the program (in the context of biomass-to-bioenergy supply chain);
- Element strategic goal, as derived from the Program strategic goals;
- Element performance goals, as derived from the Program performance goals and biorefinery pathway milestones;
- Technical and market challenges and barriers, and a demonstration and deployment elements discussions include market barriers and are addressed in the Market Expansion Section 2.2.2.5;
- Strategies for overcoming barriers, the basis for element work breakdown structures (tasks and activities with links to barriers); and
- Prioritization, milestones, and timelines.

2.1 Feedstock Supply Research and Development

The size of the U.S. bioenergy industry will, to a large degree, be determined by the quantity and quality of biomass available. As the starting material in the biomass-to-biofuels, biopower, or bioproducts supply chain, sufficient and secure supply of affordable, high quality feedstocks is a critical step in accomplishing Program goals. Feedstock Supply R&D, therefore, relates strongly to all other facets of the program portfolio; it is, however, specifically linked to the Program's Conversion and Integrated Biorefinery technology areas as feedstock is the substrate for conversion technologies.

The Program anticipates that USDA will lead the U.S. government's lignocellulosic feedstock production efforts, in accordance with the February 3, 2010 White House release of "Growing America's Fuel." The Program will work with USDA to incorporate its programmatic activities into USDA's strategy. The Program also coordinates with DOE's Office of Science (SC) on advanced feedstock production R&D via the SC Joint Genomes Institute under the Genomes-to-Life Program; the SC and USDA's National Institute on Food and Agriculture (NIFA) annual solicitation on feedstock genomics; the DOE and NIFA's annual solicitation under the Biomass Research and Development Initiative; and the SC Bioenergy Centers.

Feedstock Supply R&D supports the first element of the biomass supply chain (Figure 1-1) and includes three primary research areas: feedstock resource assessment, feedstock production, and feedstock logistics.

The conceptual flow diagram in Figure 2-5 outlines the main elements of the feedstock supply system. Process details are available in the most recent roadmap document.¹

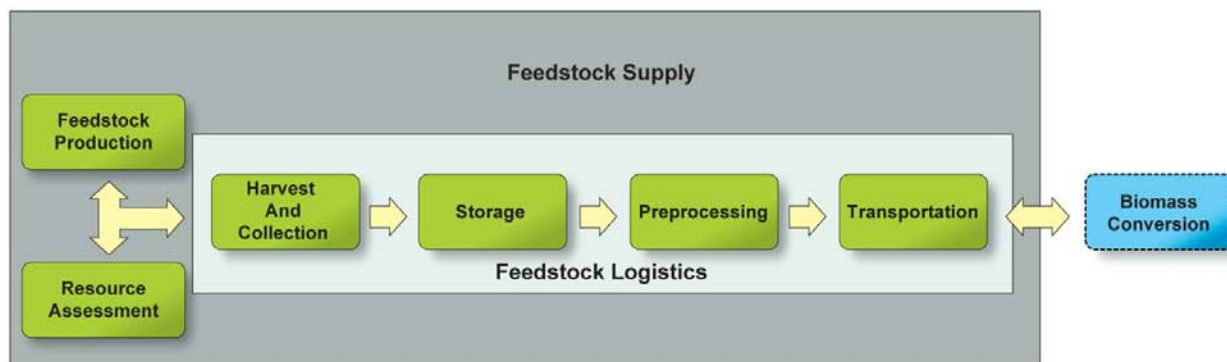

Figure 2-5: Feedstocks Supply Flow Diagram

Resource Assessment: Biomass Program feedstock resource assessment activities include identification of the geographic location, price, and environmental sustainability of accessing existing and potential future feedstock resource, as well as projecting future supply availability and prices.

Feedstock Production: Feedstock production addresses all the steps required to sustainably produce lignocellulosic and algal biomass feedstocks to the point they are ready to be collected or harvested.

Feedstocks Logistics: Feedstock logistics refers collectively to the steps that take place after the feedstock is produced but before the biomass is converted into fuels, power, or products. These unit operations include feedstock harvest, collection, storage, preprocessing, and transportation to the biorefinery.

In order to accommodate the significant differences in feedstock characteristics, conventional logistics systems will be designed and validated for two feedstock subclasses:

- Dry herbaceous (<20% moisture content; includes field dried corn stover)
- Woody (about 50% moisture; includes conventional logging / pulp wood resources)

The diversity of biomass feedstocks, including crop residues, herbaceous energy crops, woody energy crops, and forest resources will be addressed through transition from conventional agriculture and forestry biomass supply systems to advanced systems in the 2013 to 2017 timeframe.²

2.1.1 Feedstock Support of Biomass Program Strategic Goals

The Biomass Program's overarching strategic goal is to *develop sustainable, cost-competitive biomass technologies to enable the production of biofuels, biopower, and bioproducts nationwide and reduce dependence on oil through creation of a new domestic bioenergy industry, thus supporting the EISA goal of 36 bgy of renewable transportation fuels by 2022.*

Biomass feedstocks are essential to achieving this goal as they are the basis on which all other program platforms rely. The cost, quantity, and quality of feedstock available will determine the amount of biofuels that can be produced. The Feedstock strategic goal is to *develop sustainable technologies to provide a secure, reliable and affordable biomass feedstock supply for the U.S. bioenergy industry in partnership with USDA and other key stakeholders.* The ultimate outcome (2030 and beyond) of feedstock supply R&D is technology and methods that can supply over 1 billion tons per year of biomass feedstocks in a sustainable and cost-effective manner.

Feedstock Supply R&D directly addresses and supports assessment, production, harvesting, preprocessing, and delivery of feedstocks for the Agricultural Residues, Energy Crops, Forest Resources, and Algae pathways.

2.1.2 Feedstock Support of Biomass Program Performance Goals

Feedstock Supply R&D has two high-level performance goals, one for resource assessment and another for logistics:

- The feedstock resource assessment goal is to establish geographic and economic criteria under which 130 million dry tons (DT) per year would be available by 2012, and to establish geographic, economic, quality, and environmental criteria under which 250 million DT per year would be available by 2017.
- The feedstock logistics goal for dry herbaceous feedstocks (i.e., field dried corn stover) is to reduce costs from harvest to biochemical conversion plant gate to \$0.39 per gallon of ethanol (equivalent to approximately \$35/DT in 2007 \$) by 2012*, and then achieve those same cost goals for a wider range of herbaceous feedstocks by 2017. For woody feedstock resources, the logistics cost goal from harvest to gasification plant gate is \$0.49

* Table B-2 in Appendix B

per gallon of ethanol (equivalent to approximately \$35/DT in 2007 \$) by 2012, and then achieve those same cost goals for a wider range of woody feedstocks by 2017*. Cost-saving and process-improving technologies will be developed within each stage of the feedstock supply chain (Figure 2-5).

The specific **resource assessment milestones** under investigation are:

- By 2012, identify environmental (climate, water, and land use) and feedstock quality (i.e., size, chemical composition, moisture, etc.) criteria and establish a methodology for incorporation into biomass supply assessments for agricultural residues, energy crops, and forest resources pathways
- By 2013, identify environmental criteria (soil health and air quality) and establish a methodology for incorporation into biomass supply assessments for agricultural residues, energy crops, and forest resources pathways
- By 2014, integrate environmental and feedstock quality criteria into biomass supply assessments for agricultural residues, energy crops, and forest resources pathways
- By 2016, produce a fully integrated assessment of the potentially available feedstock supplies under specified criteria and conditions

The specific **feedstock logistics milestones** under investigation are:

- By 2012, validate baseline integrated feedstock logistics systems for dry corn stover and debarkable woody forest resources at field scale
- By 2015, validate advanced herbaceous and woody biomass preprocessing systems against conversion quality criteria
- By 2017, validate a fully integrated advanced feedstock logistics system that accepts all herbaceous and woody biomass resources at field scale

2.1.3 *Feedstock Technical Challenges and Barriers*

Feedstock Supply Technical Barriers

Ft-A. Feedstock Availability and Cost: The lack of credible data on price, location, environmental sustainability, quality, and quantity of available biomass feedstocks creates uncertainty for investors and developers of emerging biorefinery technologies. Estimates of current and potential feedstock resources are limited in scope and do not consider how major advances in production technologies will impact future biomass availability.

Ft-B. Sustainable Production: Existing data on the productivity and environmental effects of biomass feedstock production systems and residue collection are not adequate to support lifecycle analysis of biorefinery systems. A number of sustainability questions (such as water and fertilizer inputs, establishment and harvesting impacts on soil, etc.) have not been comprehensively addressed. New production technologies for feedstock systems such as algae are also required to address cost, productivity, and sustainability issues.

Ft-C. Feedstock Genetics and Development: The productivity and robustness of algae and other feedstocks used for biofuel production could be improved by selection, screening, breeding

* Table B-3 in Appendix B

and/or genetic engineering. This will require extensive ecological, genetic, and biochemical information, which is currently lacking for most algal species.

Feedstock Logistics Technical Barriers

Ft-D. Sustainable Harvesting: Current crop harvesting machinery is unable to selectively harvest desired components of cellulosic biomass and address the soil carbon and erosion sustainability constraints. Biomass variability places high demand and functional requirements on biomass harvesting equipment. Current systems cannot meet the capacity, efficiency, or delivered price requirements of large cellulosic biorefineries, nor can they effectively deal with the large biomass yields per acre of potential new biomass feedstock crops. In addition, feedstock specifications and standards against which to engineer harvest equipment, technologies, and methods, do not currently exist. Specifically in the case of algal biomass, current harvesting and dewatering technologies are costly and energy- and resource-intensive.

Ft-G. Feedstock Quality and Monitoring: Physical, chemical, microbiological, and post-harvest physiological variations in feedstocks arising from differences in variety, geographical location, and harvest methods are not well understood. In addition, feedstock processing standards and specifications for feedstocks are not currently available.

Ft-H. Biomass Storage Systems: Characterization and analysis of different storage methods and strategies are needed to better define storage requirements. Storage elements need to be understood as a function of feedstock source, biomass moisture, climate, storage time, and cost. Stored biomass that is or becomes wet is susceptible to spoilage, rotting, spontaneous combustion, and odor problems, therefore, the impact of these post-harvest physiological processes must be controlled to the benefit of biorefining processes.

Ft-J. Biomass Material Properties: Data on biomass quality and physical property characteristics for optimum conversion are limited. Methods and instruments for measuring physical and biomechanical properties of biomass are lacking. Information on moisture effects on quality and physical properties of biomass as affected by feedstock variability and climatic conditions is incomplete.

Ft-K. Biomass Physical State Alteration: The initial sizing and grinding of cellulosic biomass affects efficiencies and quality of all the downstream operations, yet little information exists on these operations with respect to the multiplicity of cellulosic biomass resources and biomass format requirements for biorefining. New technologies and equipment are required to process biomass between the field and conversion facilities. The harvest season for most crop-based cellulosic biomass is short, especially in northern climates, thus requiring preprocessing systems that facilitate stable biomass storage, densification, and blending for year-round feedstock delivery to the biorefinery.

Ft-L. Biomass Material Handling and Transportation: The capital and operating costs for the existing package-based equipment and facilities for handling cellulosic biomass are not cost-effective. The low density and fibrous nature of cellulosic biomass make it difficult and costly to collect, handle, and transport. For algal biomass, there is a need for characterization and analysis of collection, handling, and transportation systems.

Ft-M. Overall Integration and Scale-Up: Existing biomass harvesting, collection, storage, handling, and transport systems are not designed for the large-scale needs of integrated biorefineries. Feedstock logistics infrastructure has not been defined for various locations, climates, feedstocks, storage methods, etc. The lack of experience with integrating time-sensitive collection, storage, transportation and delivery operations to ensure year-round supply of large amounts of biorefinery feedstock is a barrier to widespread implementation of biorefinery technology. The lack of data on variability of biomass resources and how this variability affects shelf life and processing yields are further barriers. Integration of one or more aspects of the feedstock supply system—either alone or in combination with biorefinery operations—may lead to overall efficiencies. Further, the lack of analysis quantifying benefits and drawbacks of potential integration options is a barrier to cost savings and biorefinery efficiency improvement. There is also significant potential for systems integration and optimization with current algal production and logistics systems. New technologies, engineering designs, and siting strategies are required to develop more efficient ways to use resources and energy in these systems.

Ft-N. Algal Feedstock Processing: After cultivation and harvesting of algal feedstocks, algal biomass may require processing or fractionation into lipids, carbohydrates, and/or proteins before these individual components can be converted or further processed into the desired fuel or product. Current technologies for algal fractionation and product extraction are not cost-competitive, scalable, or sustainable. Options to circumvent or improve these processes exist, for example by conversion of whole algal biomass, or secretion or direct production of the desired fuel or product in culture, but little data exists on the cost, sustainability, and efficiency of these processes.

2.1.4 Feedstock Supply R&D Approach for Overcoming Challenges and Barriers

The Feedstock Supply R&D approach for overcoming feedstock supply challenges and barriers is outlined in its work breakdown structure (WBS), organized around five key activities as shown in Figure 2-6. The current feedstock supply R&D efforts are focused on assessing current and potential sustainable biomass feedstock supplies at various locations and costs; establishing a baseline for lignocellulosic feedstock productivity and environmental sustainability across all regions of the U.S.; improving the capacity and efficiency of feedstock harvesting, handling, collection, preprocessing, storage, and transportation; and controlling stability and maintaining feedstock quality throughout the logistics system operations and according to conversion specifications. In partnership with USDA and the SC, feedstock R&D activities are performed by national laboratories, universities, industry, and a variety of state and regional partners.

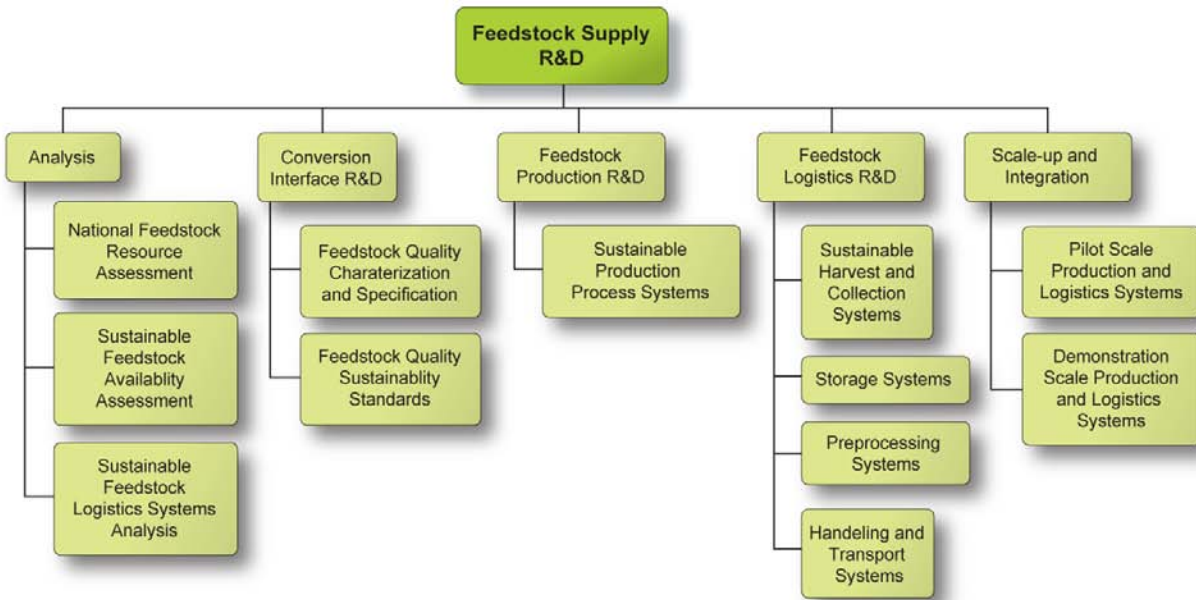

Figure 2-6: Feedstocks Supply R&D Work Breakdown Structure

The R&D approach of each WBS activity is described below, while Table 2-1 summarizes each activity's work as it relates to specific barriers and biorefinery pathways.

Analysis

The primary area of work within Analysis is resource assessment, which includes establishing an inventory of national feedstock resource potential and assessing environmentally sustainable feedstock availability now and in the future. A revised resource assessment will be released by early 2011, which will include updated biomass feedstock supply curves that incorporate county-level and environmental sustainability data under several technology scenarios. These supply curves will be updated as projections of technology and underlying market conditions evolve and will be maintained in a Web-based GIS database. Analysis also includes developing design cases and state of technology assessments for cost-effective, sustainable, and reliable delivery of cellulosic biomass resources to end use facilities, and of the production and processing of algal feedstocks. Algal resource assessments to examine algal biomass production potential are also underway. Planned R&D analysis activities for algal feedstocks and processing systems include techno-economic and lifecycle analyses for multiple algal biomass production and processing scenarios.

Conversion Interface R&D

Efficient linkage between feedstock supply and conversion processes is critical. The Conversion Interface area primarily addresses the boundary between feedstock logistics and conversion technologies by characterizing feedstock quality and identifying conversion specifications. Specific activities include the collection and organization of feedstock samples gathered from the Regional Feedstock Partnership trials and other partners for characterization. This data is shared with the feedstock producer who grew/collected the sample, as well as with Conversion R&D researchers.

Feedstock Production RD&D

The primary activity of Feedstock production RD&D is developing sustainable feedstock production processes, systems, and standards.

Program efforts to overcome feedstock production barriers and optimize lignocellulosic feedstock production regionally are implemented through the Regional Biomass Energy Feedstock Partnerships (Partnership) in conjunction with the Sun Grant Initiative, land grant universities, the national laboratories, and USDA. The Partnership is dedicated to improving the assessment and sustainable production of feedstocks in each region. It does this by working to establish a productivity baseline for dedicated herbaceous energy crops (such as sorghum, switchgrass and miscanthus), short rotation woody crops (such as hybrid poplar and willow), and agricultural residues (such as corn stover) through a series of multi-year replicated field trials. Select trial sites will also collect environmental sustainability data such as soil carbon, water use, and greenhouse gas emissions.

The Biomass Program also directly supports R&D of algal feedstocks and issues related to the sustainable production of algae-derived biofuels with the goal of creating abundant, cost-effective, and sustainable algae biomass supplies in the U.S. Algal feedstock R&D focuses on algal genetics, strain development, and algal cultivation strategies. These efforts will also factor in the economic and environmental sustainability of various routes and technologies to produce algal biofuels and bioproducts.

Feedstock Logistics RD&D

The Program's feedstock logistics R&D is focused on developing and optimizing cost-effective integrated systems for collecting, storing, preprocessing, and transporting a range of biomass feedstocks, including agricultural residues, forest resources, dedicated energy crops, and algae. Current Program efforts deal with the major challenges associated with developing a logistics system that is capable of supplying biorefiners with high density, aerobically stable, high quality biomass material. This will be achieved by improving the capacity and efficiency of each feedstock logistics unit operation. In the case of algal feedstocks, there is also a focus on developing effective ways to process or fractionate algal biomass directly into different fuel or product precursors.

Scale-up and Integration

Scale-up and Integration activities address the assimilation of feedstock production and feedstock logistics systems at scales equivalent to those addressed by the Program's Integrated Biorefinery technology area – pilot scale and demonstration scale.

Table 2-1: Feedstock Supply R&D Activity Summary

Goal: Develop sustainable technologies to provide a secure, reliable, affordable, and sustainable biomass feedstock supply for the U.S. bioenergy industry in partnership with USDA and other key stakeholders.				
WBS Element	Description	FY 2010 Performer	Barrier(s) Addressed	Pathway(s) Addressed *
Analysis	Analyze availability, cost, and sustainability of feedstocks, and feedstocks production and logistics systems <ul style="list-style-type: none"> - Inventory National Feedstock Resources by identifying, quantifying and geo-spatially analyzing total available feedstock volume, cost, and type by location - Assess Sustainable Feedstock Availability - Assess Sustainable Feedstock Logistics Supply Systems and design biomass supply systems that are cost competitive and meet supply requirements - Assess the Supply Potential for cyanobacteria, microalgae, and macroalgae-based production systems - Assess Multiple Algae Production and Processing Systems for cost-competitiveness and sustainability 	Idaho National Laboratory (INL), Oak Ridge National Laboratory (ORNL), Argonne National Laboratory (ANL), National Renewable Energy Laboratory (NREL), Pacific Northwest National Laboratory (PNNL), Sandia National Laboratory (SNL), Regional Feedstock Partnerships National Alliance for Advanced Biofuels and Bioproducts (NAABB) The National Academies/ National Research Council	Ft-A: Feedstock Availability & Cost; Ft- B: Sustainable Production; Ft- D: Sustainable Harvesting; Ft-G: Feedstock Quality and Monitoring; Ft-H: Storage Systems; Ft-J: Material Properties; Ft-K: Physical State Alteration; Ft-L: Material Handling and Transportation; Ft-M: Integration and Scale-Up; Ft-N: Algal Feedstock Processing	
Conversion Interface	Identify key feedstock characteristics and standards for/from conversion processes <ul style="list-style-type: none"> - Characterize Feedstock Composition and determine physical properties and chemical composition for Biochemical and Thermochemical conversion 	INL, NREL, ORNL, Regional Feedstock Partnerships NAABB	Ft-B: Sustainable Production; Ft-J: Material Properties	Agricultural Residues
Feedstock Production RD&D	Develop feedstocks, sustainable agronomic practices and feedstocks production processes and systems <ul style="list-style-type: none"> - Develop Sustainable Production Processes/Systems to increase yield and lower cost - Develop and Test Feedstock Production Standards - Discover, Breed, or Engineer Algae strains that are productive and robust 	INL, ORNL, Regional Feedstock Partnerships NAABB Montana State University Utah State University	Ft-A: Feedstock Availability & Cost; Ft-B: Sustainable Production; Ft-C: Feedstock Genetics and Development;	Energy Crops* Forest Resources Algae
Feedstock Logistics RD&D	Develop, test, and demonstrate sustainable feedstocks logistics systems <ul style="list-style-type: none"> - Develop Sustainable Harvest and Collection Systems with improved efficiency, reduced costs, and increased biomass tonnages - Develop Algal Processing Systems - Develop Feedstock Storage Systems that meet year-round facility supply needs - Develop Pre-processing Systems to improve bulk density and meet conversion / IBR requirements - Develop handling and transportation methods and systems 	INL ORNL NREL NAABB	Ft-D: Sustainable Harvesting; Ft-G: Feedstock Quality and Monitoring; Ft-H: Storage Systems; Ft-J: Material Properties; Ft-K: Physical State Alteration; Ft-L: Material Handling and Transportation; Ft-M: Integration and Scale-Up; Ft-N: Algal Feedstock Processing	
Scale-up and Integration	Complete Systems level demonstration and validation of all key technologies to utilize feedstocks in existing or new facilities <ul style="list-style-type: none"> - Demonstrate/Validate Pilot Scale Integrated Feedstock Production and Logistics Systems - Demonstrate/Validate Demonstration Scale Integrated Feedstock Production and Logistics Systems 	Genera, Agco, Auburn University, State University of New York, FDC Enterprises, INL, University of Tennessee	Ft-A: Feedstock Availability and Cost; Ft-B: Sustainable Production; Ft-M: Overall Integration and Scale-up	

* Denotes primary feedstock pathway under investigation

2.1.5 *Prioritizing Feedstock Supply R&D Barriers*

In order to achieve the Feedstock R&D goal of developing sustainable technologies to provide a secure, reliable, and affordable biomass feedstock supply for the U.S. bioenergy industry, all of the challenges and barriers identified need to be addressed. However, the following four issues are critical and will be emphasized within the platform's efforts:

- Incorporate sustainability considerations in assessment of current and future biomass resource quantities, prices, and characteristics.
- Develop baseline productivity for major feedstocks on a regional and sustainable basis.
- Develop feedstock materials to meet density targets and other physical characteristics associated with a uniform format feedstock supply.
- Develop commercial-scale biomass supply systems by increasing capacity and efficiency of associated unit operations.

Figures 2-7 and 2-8 illustrate how the Feedstock platform utilizes analysis to prioritize efforts in overcoming technical barriers. Figure 2-7 shows preliminary estimates of different feedstock quantities potentially accessible at specific grower payments (see Appendix B, Table B-1 for details).^{*} The revised resource assessment will provide improved estimates.

Grower payments are those made to feedstock producers over and above those for harvest, collection, storage, preprocessing, and transport. The grower payment is a national price that would provide the grower a competitive profit for the use of the land or is sufficient, in the case of residues, to induce the grower to allow the residue to be harvested. As larger quantities of biomass feedstocks are required, the grower price increases. For crop residues, the grower payment covers the environmental value of the residue removed (e.g., nutrients and organic matter) as well as profit. For woody residues, these cover the value of the residue. For dedicated energy crops, grower payments cover pre-harvest machine costs, variable inputs such as fertilizers and seed, and amortized establishment costs for perennial crops. The payments must also reflect what profit the land could produce if planted with other crops. Other aspects affect grower payments, such as profits to growers for investment returns and risk taking, alternative financial arrangements (e.g., cooperatives), fixed pricing mechanisms, shared-equity arrangements between growers and processors, and other competitive uses.

From 2010 through 2012, the demand for cellulosic feedstocks is projected to be limited and thus grower payment costs are quite low (Appendix B-1). Similarly, demand for woody feedstocks for biofuels is also projected as a limited niche demand through 2012. In 2017 the demand for cellulosic feedstocks will have expanded and the required grower payment is expected to increase. The grower payment for 2017 will be re-evaluated based on EISA demand. The woody and herbaceous grower payments are currently estimated to be \$26.20/DT (Appendix B-1).

^{*} Corn stover, cereal straw and switchgrass quantities are based on 2006 preliminary updated information from R. Perlack on feedstock supply curve analysis in progress. Updated analysis is scheduled to be published in late 2010/early 2011. Forest residue information is consistent with assumptions from the 2005 Billion Ton study.

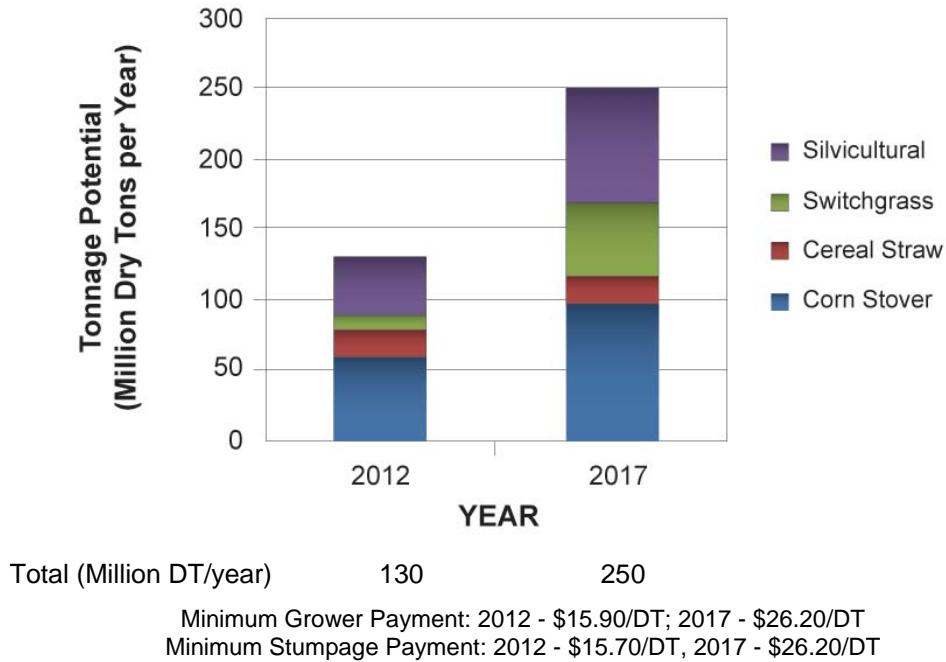

Figure 2-7: Projected Feedstock Availability at Specified Minimum Grower Payments

Figure 2-8 and Table 2-2 show the magnitude of the potential reduction in the logistics costs for dry herbaceous feedstocks that can be obtained with technology development. Detailed information on the technical performance targets that form the basis for the conceptual logistics system designs and cost estimates are provided in Appendix B, Tables B-2 and B-3 for herbaceous and woody systems respectively. These targets are for the current baseline concept for collection, storage, preprocessing, transportation, and delivery to conversion plant gate. Table 2-3 shows the targeted reductions in logistics costs for woody feedstocks through technology development. Note that the herbaceous logistics system design is more fully developed than the woody design. An updated, detailed woody logistics system design is anticipated early next year.

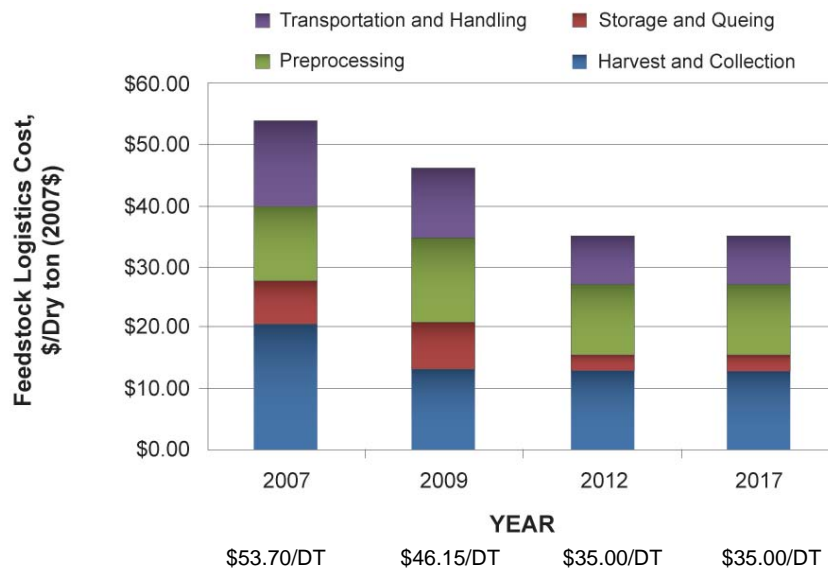

Figure 2-8: Dry Herbaceous (i.e., field dried corn stover) Feedstock Logistics Costs

Table 2-2: Dry Herbaceous (i.e., field dried corn stover) Feedstock Logistics Costs (2007\$s)³

	2007	2009	2012	2017
Total Feedstock Logistics, \$/DT	\$53.70	\$46.15	\$35.00	\$35.00
Harvest and Collection	\$20.35	\$13.30	\$12.15	\$12.15
Storage and Queuing	\$7.25	\$7.25	\$2.45	\$2.45
Preprocessing	\$12.40	\$14.15	\$11.50	\$11.50
Transportation and Handling	\$13.70	\$11.45	\$7.90	\$7.90
Total Feedstocks Logistics, \$/gal Ethanol	\$0.75	\$0.54	\$0.39	\$0.39
Harvest and Collection	\$0.28	\$0.16	\$0.15	\$0.15
Storage and Queuing	\$0.10	\$0.09	\$0.03	\$0.03
Preprocessing	\$0.17	\$0.16	\$0.13	\$0.13
Transportation and Handling	\$0.19	\$0.13	\$0.11	\$0.09
<i>Gallons Ethanol/Dry Ton</i>	71.90	77.70	89.90	89.90

Table 2-3: Woody Feedstock Logistics Costs (2007\$s)⁴

	2007	2009	2012	2017
Total Feedstock Logistics, \$/DT	\$51.85	\$42.50	\$35.00	\$35.00
Total Feedstock Logistics, \$/gal Ethanol	\$1.21	\$0.69	\$0.49	\$0.49

2.1.6 Feedstock Platform Milestones and Decision Points

The key Feedstock platform milestones, inputs/outputs, and decision points to complete the tasks described in [Section 2.1.4](#) are summarized in the chart in Figure 2-9.

Figure 2-9: Feedstock Supply R&D Gantt Chart

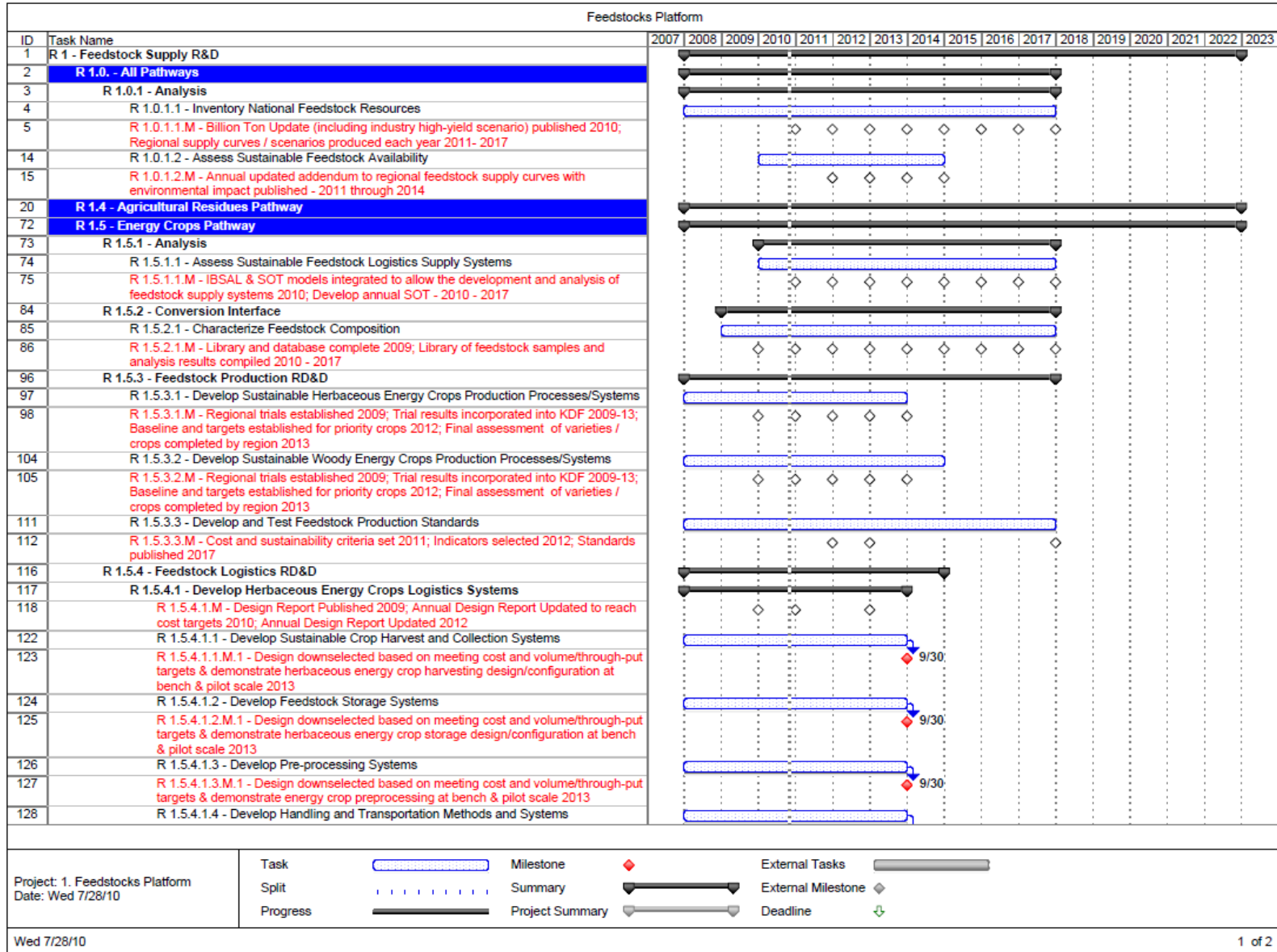

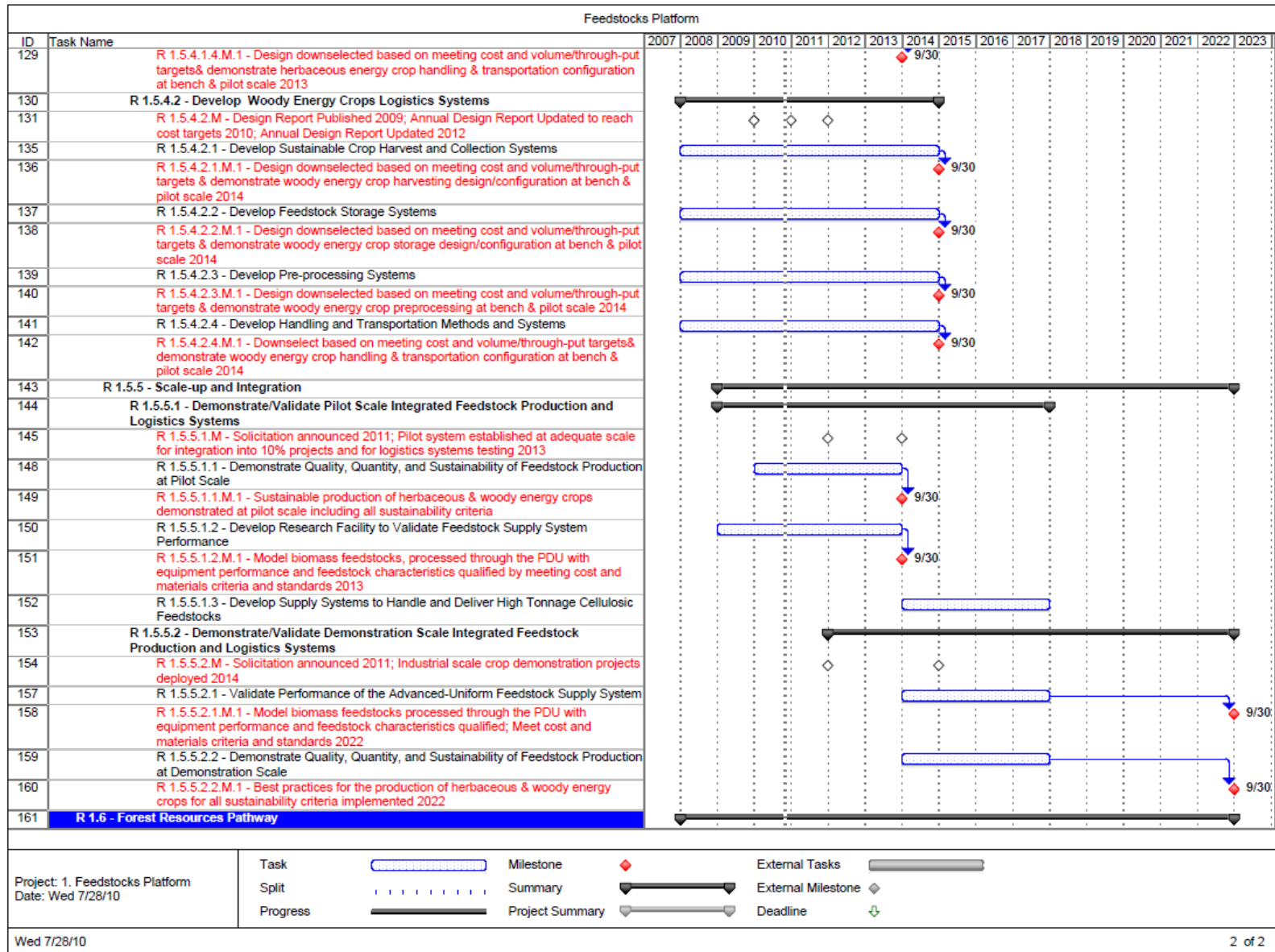

2.2 Conversion Research and Development

The strategic goal of conversion research and development (R&D) is to *develop technologies for converting feedstocks into cost-competitive liquid transportation fuels, as well as bioproducts and biopower*. The diversity of the biomass resource leads to the need to develop multiple conversion technologies that can efficiently deal with the broad range of feedstock materials, as well as their physical and chemical characteristics. The Program splits its conversion R&D efforts into two areas: Biochemical Conversion R&D and Thermochemical Conversion R&D (Figure 2-10). Within each area, there are many possible variations, but the main differences are in the primary catalytic system employed and the intermediate building blocks produced.

While the Program addresses the Conversion R&D needs through two separate technology areas – Biochemical and Thermochemical, it is envisioned that the combined use of technologies from both areas offers the greatest opportunity for optimizing biomass conversion into a variety of different fuels, chemicals, and energy products. The early years of the industry may not see such complex biorefineries, but some complexity may be added as technologies evolve with time.

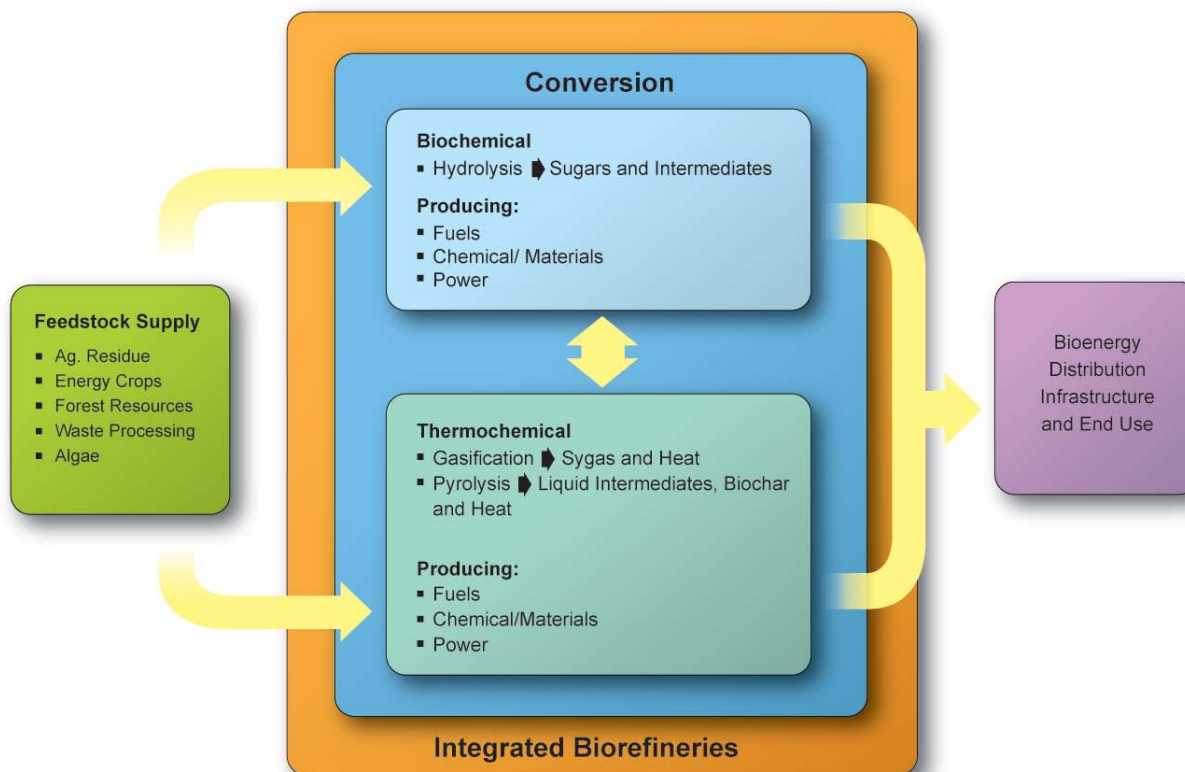

Figure 2-10: Conversion Routes for Biomass to Bioenergy

2.2.1 Biochemical Conversion Research and Development

Biochemical Conversion R&D is focused on reducing the cost of converting lignocellulosic biomass to mixed, dilute sugars and further conversion to liquid transportation fuels.

Biochemical conversion uses biocatalysts, such as enzymes and microorganisms, in addition to heat and chemical catalysts, to convert the carbohydrate portion of the biomass (hemicellulose

and cellulose) into an intermediate sugar stream. The biomass sugars act as intermediate building blocks, which are then biologically or chemically converted to various liquid fuels and other products. Biological conversion processes typically utilize organisms such as yeast, filamentous fungi, bacteria, or algae to convert intermediate products (sugars) via fermentation or other metabolic pathways. Alternatively, chemical conversion employs catalysts to drive the reactions to specific product suites. The remaining lignin portion of the biomass can be used for heat and power or, alternatively, to produce additional fuels and chemicals.

Biochemical Conversion R&D will make further improvements to feedstock interface, pretreatment and conditioning, hydrolysis and sugar processing, in addition to process integration in order to reduce conversion costs; these economically viable technologies will act as the springboard to launching the next generation technology to produce liquid fuels and other products from a wide range of cellulosic feedstocks.

The Program is investigating other biological conversion routes to advanced biofuels, utilizing such chemistries as direct biomass conversion and waste-to-energy conversion process technologies.

Biochemical Conversion Unit Operations

The conceptual block flow diagram in Figure 2-11 outlines the main technologies/unit operations of the baseline biochemical biomass-to-fuel process. Process details for the biological processing route to ethanol are available in the most recent design report.⁵

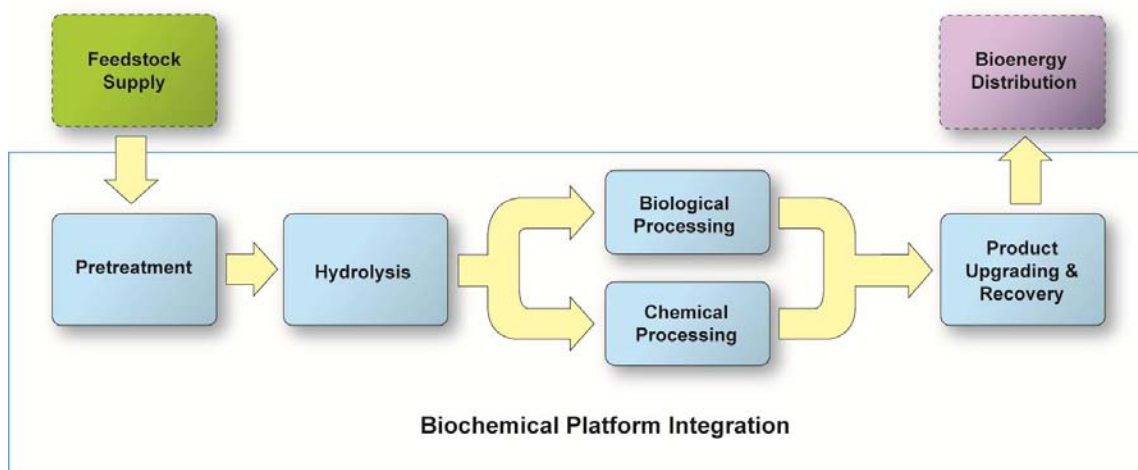

Figure 2-11: Biochemical Conversion Route for Biomass to Biofuels

Pretreatment: In this step, biomass feedstock undergoes a thermochemical process to break down the hemicellulose fraction of the feedstock into a mixture of soluble five-carbon sugars – xylose and arabinose, and soluble six-carbon sugars – mannose, galactose, and glucose. This partial solubilization makes the remaining solid cellulose fraction more accessible for enzyme saccharification later in the process. A small portion of the cellulose is often converted to glucose in this step, and a portion of the lignin fraction may also be solubilized. The specific mix of sugars released depends on the feedstock used and the pretreatment technology employed.

Conditioning: In some process configurations, the pretreated material goes through a hydrolysate conditioning and/or neutralization process which removes undesirable byproducts from the pretreatment process that are toxic to the fermenting organism and adjusts the pH of the reactant.

Hydrolysis/Saccharification: In the hydrolysis step, the pretreated material with the remaining solid carbohydrate fraction, primarily cellulose, is saccharified, releasing glucose. This can be done with enzymes such as cellulases. Addition of other enzymes such as xylanases in this step may allow for less severe pretreatment, resulting in a reduced overall pretreatment and hydrolysis cost. Depending on the process design, enzymatic hydrolysis requires from several hours to several days, after which the mixture of sugars and any unreacted cellulose is transferred to the fermenter. Currently, the process concept under development assumes that the cellulase enzymes are purchased from enzyme companies, like other consumable catalysts and chemicals. The current concept may also combine the hydrolysis and fermentation steps.

Biological Processing: Currently a fermentation step, an inoculum of a fermenting organism is added and fermentation of all sugars to ethanol is carried out while continuing to utilize the enzymes for further glucose production from any remaining solid cellulose. After a few days of fermentation and continued saccharification, nearly all of the sugars are converted to ethanol. The resulting mixture is sent to product recovery. Other routes, both fermentative and non-fermentative, to ethanol and other biofuels and bioproducts are being explored as well.

Chemical or Catalytic Processing: Chemical or catalytic conversion can be used in place of or in addition to fermentation to convert the hydrolysis products, be they sugars, alcohols or a variety of other stable oxygenates to the desired fuel. The addition of a catalyst works to make a reaction less energy intensive, thus making the entire process more efficient. However, different reactions achieve different yields and intermediates while targeting different end fuels, so the research is aimed at identifying optimum combinations with respect to process efficiency, feedstock utilization, cost, sustainability, and finished product characteristics. Additionally, chemical processing could produce bioproducts, however, this is not a current Program focus.

Product Upgrading and Recovery: Product upgrading and recovery varies based on the type of conversion used and the type of product generated, but in general, involves any necessary hydrogenation of alkenes, distillation, and some cleanup processes to separate the fuel from the water and residual solids. Residual solids are composed primarily of lignin which can be burned for combined heat and power generation, chemically converted to intermediate chemicals, or also converted to synthesis gas or pyrolysis oil intermediates for other uses.

Biochemical Conversion Interfaces

Feedstock Logistics Interface: Feedstock logistics provides preprocessed feedstock materials that will meet requirements (composition, quality, size, etc.) as established by the baseline biochemical conversion process configuration. Close coordination between the Feedstock and Biochemical Conversion R&D is necessary to ensure that the feedstock and the conversion process are optimized in relation to each other such that feedstock materials of sufficient quantity and quality are readily available for the lowest overall cost and highest conversion efficiency.

Biofuels Distribution Interface: The next step in the biomass-to-biofuels supply chain is the biofuels distribution step. Biofuels leaving a biorefinery must meet all applicable federal, state and local codes and standards. As the Program broadens its biochemical conversion R&D portfolio from ethanol to include infrastructure-compatible hydrocarbons, close coordination with traditional petroleum refiners will be beneficial in ensuring desired product quality characteristics.

2.2.1.1 Biochemical Conversion R&D Support of Program Strategic Goals

The Biochemical platform's strategic goal is to *develop technologies for converting feedstocks into cost-competitive liquid transportation fuels, as well as bioproducts and biopower.*

Biochemical Conversion R&D directly addresses and supports production of fuels through agricultural residues and energy crops processing pathways. It also indirectly supports production of bioproducts from both these pathways and of both biofuels and bioproducts from the algae and waste processing (e.g., via anaerobic digestion) pathways.

2.2.1.2 Biochemical Conversion R&D Support of Program Performance Goals

The overall near-term performance goal of Biochemical Conversion R&D is to reduce the estimated mature technology processing cost* for converting cellulosic feedstocks to ethanol to \$0.92 per gallon by 2012 (see Figure 2-14 for additional information) based on data at the integrated pilot scale. Post 2012 targets for biomass-derived hydrocarbons that are more infrastructure compatible than ethanol are under development and will be informed by current analysis activities, including the consortia, to support the 2017 programmatic cost goals (\$2.85 per gallon of renewable gasoline, \$2.84 per gallon of renewable diesel, and \$2.76 per gallon of renewable jet)

The current performance milestone for the pathway under near-term investigation is:

- By 2012, validate integrated production of ethanol from corn stover via biochemical conversion route at scale sufficient to enable transfer of technology to pilot operation.

2.2.1.3 Biochemical Conversion Technical Challenges and Barriers

Bt-A. Biomass Fractionation: Fractionation can be used to increase the value of the individual components in biomass prior to their subsequent conversion to products. Currently, the interactions between chemical, biological, solvation (ability to go into solution), and mechanical processes that ultimately allow biomass to be more efficiently fractionated into high purity components prior to conversion are insufficiently understood or simply too costly to implement commercially.

Bt-B. Biomass Variability: The characteristics of biomass feedstock materials can vary widely in terms of physical and chemical composition, size, shape, moisture content, and bulk density. These variations can make it difficult (or costly) to supply biorefineries with feedstocks of

* Estimated mature technology processing cost means that the capital and operating costs are assumed to be for an "nth plant" where several plants have been built and are operating successfully so that additional costs for risk financing, longer startups, under performance, and other costs associated with pioneer plants are not included.

consistent, acceptable quality year-round. Additionally, this feedstock variability affects overall conversion rate and product yield of biomass conversion processes.

Bt-C. Biomass Recalcitrance: Lignocellulosic biomass feedstocks are naturally resistant to chemical and/or biological degradation. The fundamental role of biomass structure and composition and the critical physical and chemical properties that determine the susceptibility of cellulosic substrates to hydrolysis are not well understood. This lack of understanding of the root causes of the recalcitrance of biomass limits the ability to direct efforts to improve the cost-effectiveness and efficiency of pretreatment and other fractionation processes.

Bt-D. Pretreatment Chemistry: Prehydrolysis of biomass, typically referred to as pretreatment, is required to break down the structure of biomass and increase its susceptibility to subsequent enzymatic hydrolysis by cellulase enzymes. There is a lack of understanding of critical physical and chemical properties that determine the susceptibility of cellulosic substrates to hydrolysis and the role that lignin and other pretreatment products play in impeding access to cellulose on a molecular level. Continued cost reductions in pretreatment technologies via improved sugar yields and quality require developing a better understanding of pretreatment process chemistries, including the kinetics of hemicellulose and cellulose hydrolysis.

Bt-E. Pretreatment Costs: Pretreatment reactors typically require expensive construction materials to resist acid or alkali attack at elevated temperatures. In addition, the impact of reaction configuration and reactor design on chemical cellulose prehydrolysis is not well understood. Developing lower-cost pretreatment depends on the ability to process the biomass in reactors designed for maximum solid levels and fabricated from cost-effective materials.

Bt-F. Cellulase Enzyme Production Cost: Cellulase enzymes remain a significant portion of the projected production cost of sugars from cellulosic biomass. Cost-effective enzyme production technologies are not currently available, although significant progress has been made through concerted efforts both within the Program and with industrial enzyme producers.

Bt-G. Cellulase Enzyme Loading: Reducing the cost of enzymatic hydrolysis depends on identifying more efficient enzyme preparations and enzyme hydrolysis regimes that permit more cost-effective and lower ratios of enzyme to substrate to be used. Currently available enzymes are not sufficiently thermotolerant and suffer from substantial resistance to sugar end-product inhibition. Developing enzymes that enable low-cost enzymatic hydrolysis technology requires more understanding of the fundamental mechanisms underlying the biochemistry of enzymatic cellulose hydrolysis, including the impact of biomass structure on enzymatic cellulose decrystallization. Additional efforts aimed at understanding the interaction of cellulases with cellulose and the necessary process environment at a molecular level are needed to achieve the specific activity improvements which can further reduce cellulase cost.

Bt-I. Cleanup/Separation: Sugar solutions resulting from pretreatment and hydrolysis are impure, containing a mixture of sugars and a variety of non-sugar components. Potential impurities include acetic acid liberated upon hydrolysis of hemicellulose, lignin-derived phenolics solubilized during pretreatment, inorganic acids or alkalis or other compounds introduced during pretreatment, various salts, and hexose and pentose sugar degradation or

transglycosylation products. The presence of some of the non-sugar components can inhibit microbial fermentation or biocatalysis or can poison chemical catalysts. Low-cost purification technologies need to be developed that can remove impurities from hydrolysates and provide concentrated, clean sugar feedstocks to manufacture biofuels and biobased products.

Bt-J. Catalyst Development: There is a need for biological or chemical catalysts for production of advanced biofuels (such as ethanol, renewable gasoline, or diesel) and other bioproducts from the sugar mixture and inhibitors in the hydrolysate broth produced during biomass pretreatment and hydrolysis. Improvement in the robustness of catalysts and their ability to perform in hydrolysate broths can significantly lower capital costs.

Bt-K. Biological Process Integration: Process integration remains a key technical barrier hindering development and deployment of biochemical conversion technologies. Biochemical conversion technologies currently present large scale-up risks given the lack of high-quality performance data on integrated processes carried out at the high solids conditions required for industrial operations. The effect of feed and process variations throughout the process must be understood to ensure robust, efficient biorefineries. Process integration work is essential for characterizing the complex interactions that exist between many of the processing steps, identifying unrecognized separation requirements, addressing bottlenecks and knowledge gaps, and generating the integrated performance data necessary to develop predictive mathematical models that can guide process optimization and scale-up.

Bt-L. Biochemical/Thermochemical Interface: Integration of the entire biorefinery is the final conversion barrier and overcoming it will require successful integration at the interfaces between the biochemical and thermochemical processes. Without planned and managed integration, the complete picture of biomass conversion to fuels and chemicals will not be clear enough to attract potential developers as the risks of commercialization will be too high for financiers. As conversion technologies mature, higher levels of integration will be feasible and second generation biorefineries are envisioned that will closely couple biochemical / thermochemical facilities, enabling the most efficient use of a wide range of feedstocks.

2.2.1.4 Biochemical Conversion R&D Approach for Overcoming Challenges and Barriers

The approach for overcoming biomass conversion technical challenges and barriers outlined in Figure 2-12 has five key elements which are further broken down into activities.

Current efforts are focused on overcoming the recalcitrance of biomass; validating advanced conversion enhancements such as increased solids loadings, improved separation, and milder process conditions; developing more robust fermentation organisms; and integrating conversion technologies with upstream feedstock collection/transport processes. Research which addresses the key technical barriers is performed by national laboratories, industry, and universities. Relevance of the R&D portfolio to industrial and commercial applications will be ensured via project stage gate and biennial portfolio reviews with a panel of external experts, partnering with industry as appropriate, and patenting and publishing the results.

The R&D approach of each group of activities is described below, while Table 2-4 summarizes each activity element's work as it relates to specific barriers and biorefinery pathways.

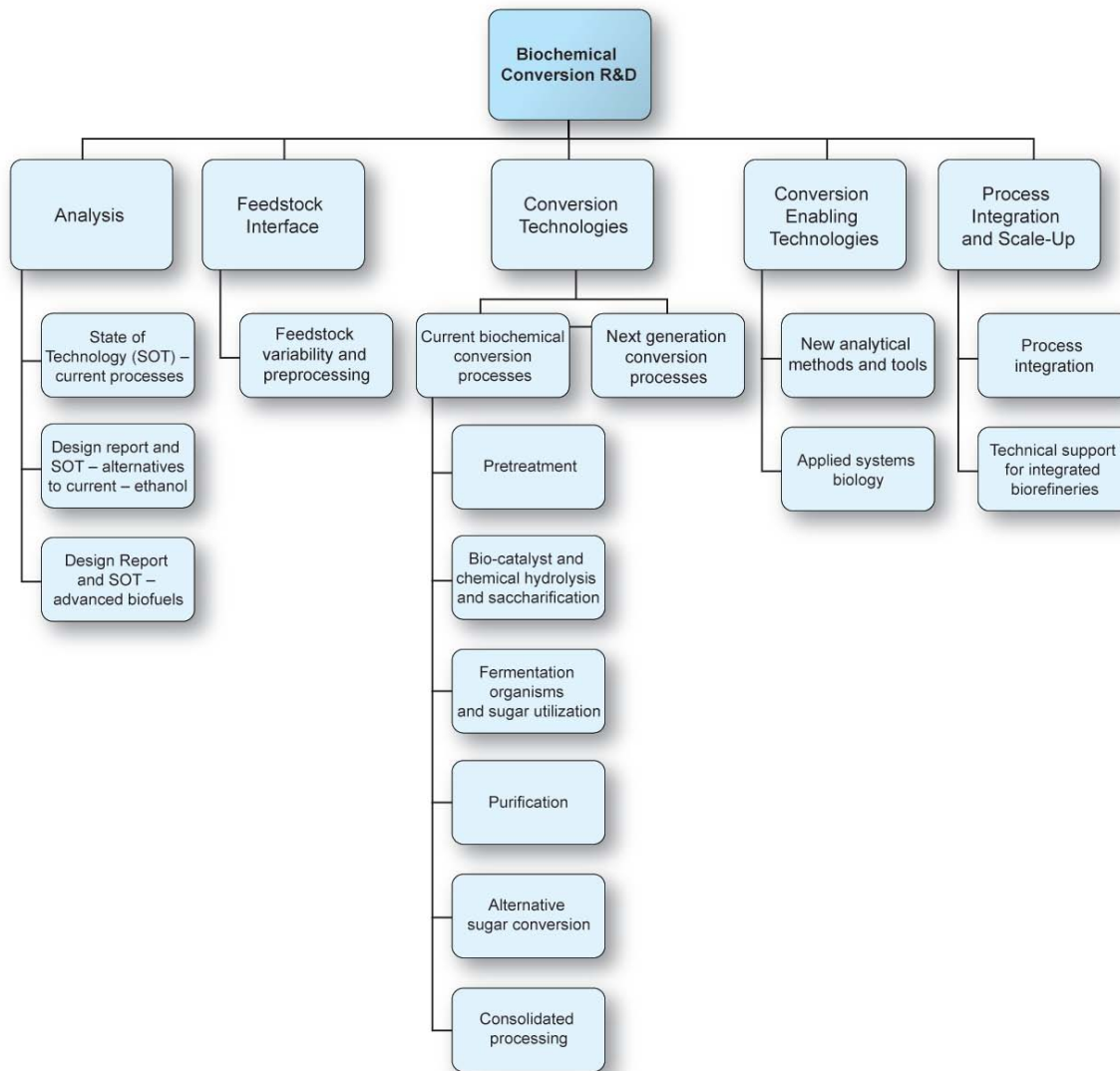

Figure 2-12: Work Breakdown Structure for Biochemical Conversion R&D

Analysis

Analysis activities play a critical role in investigating the potential of new conversion methods, establishing baselines, developing targets, and monitoring progress of the research portfolio. Techno-economic modeling activities have been used to develop technical and related cost targets by unit operation. The resulting models can be utilized to determine the impact of process trade-offs (both economic and technical), as well as define the current state of technology. Additionally, lifecycle analysis is used to assess the sustainability of the conversion processes.

Feedstock-Biochemical Interface R&D

Establishing the impact of and requirements for feedstock assembly processes to feed bioconversion processes are necessary for the development of biorefineries. Linking feedstock harvest/collection/transport processes with conversion processes allows for evaluation of technology options and trade-offs on both sides of the processing interface and ensures a fully integrated process from stump to fuel. Activities will develop cost and quality specifications for

feedstock assembly technologies that are compatible with the biochemical conversion technologies. *The key 2012 technical target is to maintain or even improve feedstock yield potential through targeted logistics operations between the field or forest and the biorefinery.*

Conversion Technologies

Overcoming the barriers associated with high capital and operating costs and sub-optimal process yields is key to developing an integrated biochemical conversion process. The investigation and evaluation of pretreatment approaches are aimed at reducing the cost of pretreatment and increasing the digestibility of residual cellulose and hemicellulose in pretreated biomass. Fundamental and applied research is focused on improving the existing enzyme cocktails and fermentation organisms, expanding the knowledge of new organisms/catalysts, and developing advanced technologies to overcome the key rate-limiting steps in the conversion of biomass to advanced biofuels and products. *The key 2012 technical targets involve achieving higher yields of cleaner sugars and lower fuel conversion costs in the processing steps of pretreatment, enzymatic hydrolysis, and fermentation.*

Conversion Enabling Technologies

The biorefinery of the future will require efficient and highly productive enzyme and fermentative organisms for biofuel production. Optimizing the microbial cell factories that will produce these enzymes is important and requires a fundamental understanding of the biological processes governing protein secretion, a range of metabolic pathways, and metabolite transport. In addition, a fundamental understanding of the factors and causes underlying the recalcitrance of biomass to biological and chemical degradation is needed to make processing more specific and less costly. The development of tools such as molecular modeling and cell wall microscopy will enable a more complete understanding of biomass structure and the most appropriate methods to convert it.⁶ *The key technical target is developing tools (molecular and systems biology based) that can assist in providing basic knowledge of biomass and biological systems which can be used to develop new or improved technologies that increase conversion efficiency and/or reduce conversion cost.*

Process Integration and Scale-up

Investigating pretreatment and enzymatic hydrolysis technologies together with downstream synthesis can help identify the issues as well as the opportunities for integration. Integration of biomass process steps can improve overall efficiency, reduce costs, and is a necessary precursor for scale-up activities. In addition, the effect of feed and process variations throughout the process must be understood to ensure robust, efficient biorefineries that produce fuels and products on a consistently cost-effective basis. Lessons learned from these activities will be shared with the biochemical conversion-related integrated biorefineries to promote technology transfer. *The key technical target is to maintain the high conversion rates demonstrated during individual unit operations in an integrated process configuration, ideally at high-solids loadings.*

Table 2-4: Biochemical Conversion R&D Activity Summary

Goal: Develop technologies for converting feedstocks into cost-competitive commodity liquid fuels, such as ethanol, renewable gasoline, renewable jet fuel, and renewable diesel, as well as bioproducts and biopower				
WBS Element	Description	FY10 Performer(s)	Barrier(s) Addressed	Pathway(s) Addressed*
Analysis	Develop integrated conversion process designs, assess techno-economic feasibility and progress, and evaluate sustainability / lifecycle impacts <ul style="list-style-type: none"> • Current to biochemical processes and alternatives • Biochemical and hybrid processes for advanced biofuels 	NREL PNNL	Bt-K: Biological Process Integration	<ul style="list-style-type: none"> • Agricultural Residues • Energy Crops
Feedstock Interface	Develop feedstock specifications and processing systems that accommodate feedstock variability and optimize conversion processes <ul style="list-style-type: none"> • Validate the impacts of feedstock variability and preprocessing on biochemical conversion processes 	INL NREL	Ft-J: Biomass Materials Properties, Ft-M: Overall Integration, Bt-B: Biomass Variability, Bt-F: Cellulase Enzyme Production Cost, Bt-G: Cellulase Enzyme Loading	
Conversion Technologies	R&D on the most promising technology routes based on lifecycle analyses (environmental and techno-economic) and preliminary investigation into new emerging routes <ul style="list-style-type: none"> • Reduce the current cost of biochemical conversion processes to ethanol through R&D in pretreatment, fermentation, chemical processing, purification and alternative/combined processes. • Identify technically feasible next generation biochemical conversion processes including optimizing the integration between biochemical and thermochemical processes 	NREL, PNNL, ANL, ORNL, Danisco USA Inc., DSM Innovation Inc., Novozymes Inc., Verenum Corporation, Cargill, DuPont, Mascoma, Purdue University	Bt-A: Biomass Fractionation, Bt-B: Biomass Variability, Bt-C: Biomass Recalcitrance, Bt-D: Pretreatment Chemistry, Bt-E: Pretreatment Costs, Bt-F: Cellulase Enzyme Production Cost, Bt-G: Cellulase Enzyme Loading, Bt-I: Cleanup/Separation, Bt-J: Catalyst Development, Bt-K: Biological Process Integration, Bt-L: Biochemical/Thermochemical Processing Integration	
Conversion Enabling Technologies	Enhance existing enabling technologies, investigate promising improvements in non-route-specific unit operations and develop non-route-specific conversion technologies <ul style="list-style-type: none"> • Develop new analytical methods and tools to enhance understanding of basic mechanisms in biomass conversion • Engage applied systems biology applications to address biochemical conversion-specific needs 	NREL PNNL	Bt-C: Biomass Recalcitrance, Bt-K: Biological Process Integration	
Integration and Scale-Up	Integrate unit operations and scale up to reduce cost of sustainable biomass conversion to fuels <ul style="list-style-type: none"> • Integrate current biochemical conversion process unit operations • Fully integrate emerging biochemical conversion process unit operations to advanced biofuels • Identify needs of Integrated Biorefinery projects and provide limited unit-operations-focused R&D to enable successful performance 	NREL; Cargill; ANL; DuPont; Purdue University; ORNL	Bt-K: Biological Process Integration, Bt-L: Biochemical/Thermochemical Processing Integration	
<p>Beyond 2017: Focus on understanding the scientific basis for biomass conversion and identifying how to exploit. Beyond 2017, the identification of new conversion options is expected to lead to a series of generations of improved technologies that will be developed, demonstrated, and ultimately deployed. Process consolidation is a common theme envisioned in the future of biochemical conversion where advanced technology will combine several unit operations and improve the pretreatment operation.</p>				

* Denotes primary feedstock pathway under investigation

2.2.1.5 Prioritizing Biochemical Conversion Barriers

In order to achieve the Biochemical Conversion R&D goals, all of the challenges and barriers need to be addressed. However, the following two issues are critical and will be emphasized within Biochemical Conversion R&D efforts:

- Lowering/stabilizing enzyme costs and understanding enzyme companies' marketing strategy
- Moving beyond fermentation-to-ethanol technologies by developing:
 - fermentative organisms
 - catalysts
 - other hybrid bio/chemical conversion routes

Figure 2-13 illustrates the prioritization of Biochemical Conversion R&D efforts in overcoming the identified technical barriers based on analysis results.⁷ The figure shows that the largest expected reduction in the cost of sugars will be obtained with biochemical conversion technology development in the areas of pretreatment, enzymes, and fermentation organisms. R&D activities are, therefore, primarily focused in these areas.

Detailed information on the technical targets that form the basis for the conceptual biochemical conversion systems design and cost estimates in Figure 2-13 are provided in Appendix B, Table B-4.⁸ The status and targets are based on conversion of dry corn stover via dilute acid pretreatment, enzymatic hydrolysis, ethanol fermentation and recovery, with lignin combustion for combined heat and power production. The State of Technology status and projections are modeled production costs at 2,000 dry tons feedstock/day using data from NREL's bench-scale biochemical conversion R&D.

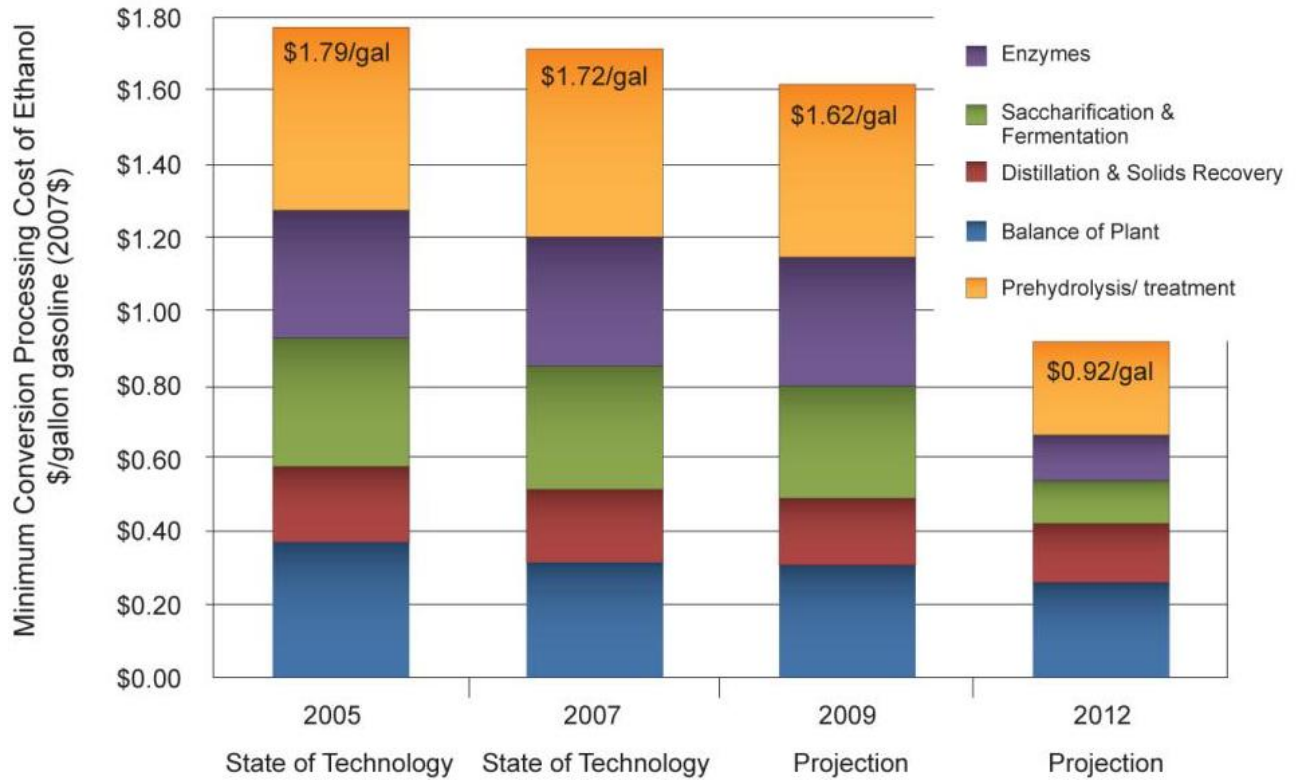

	2005 State of Technology	2007 State of Technology	2009 Projection	2012 Projection
Processing Total*	\$1.79	\$1.72	\$1.62	\$0.92
Prehydrolysis/ treatment	\$0.50	\$0.51	\$0.47	\$0.26
Enzymes	\$0.35	\$0.35	\$0.35	\$0.12
Saccharification & Fermentation	\$0.35	\$0.34	\$0.31	\$0.12
Distillation & Solids Recovery	\$0.21	\$0.19	\$0.18	\$0.16
Balance of Plant	\$0.37	\$0.32	\$0.31	\$0.26

*Note: rounding of numbers and subsequent summation is explained in Table B4 in Appendix B

Figure 2-13: Biochemical Conversion of Corn Stover to Ethanol (\$/gal in 2007\$)

2.2.1.6 Biochemical Conversion R&D Milestones and Decision Points

The key Biochemical Conversion R&D milestones, inputs/outputs, and decision points to complete the tasks described in [Section 2.2.1.4](#) are summarized in the chart in Figure 2-14.

Figure 2-14: Biochemical Conversion R&D Gantt

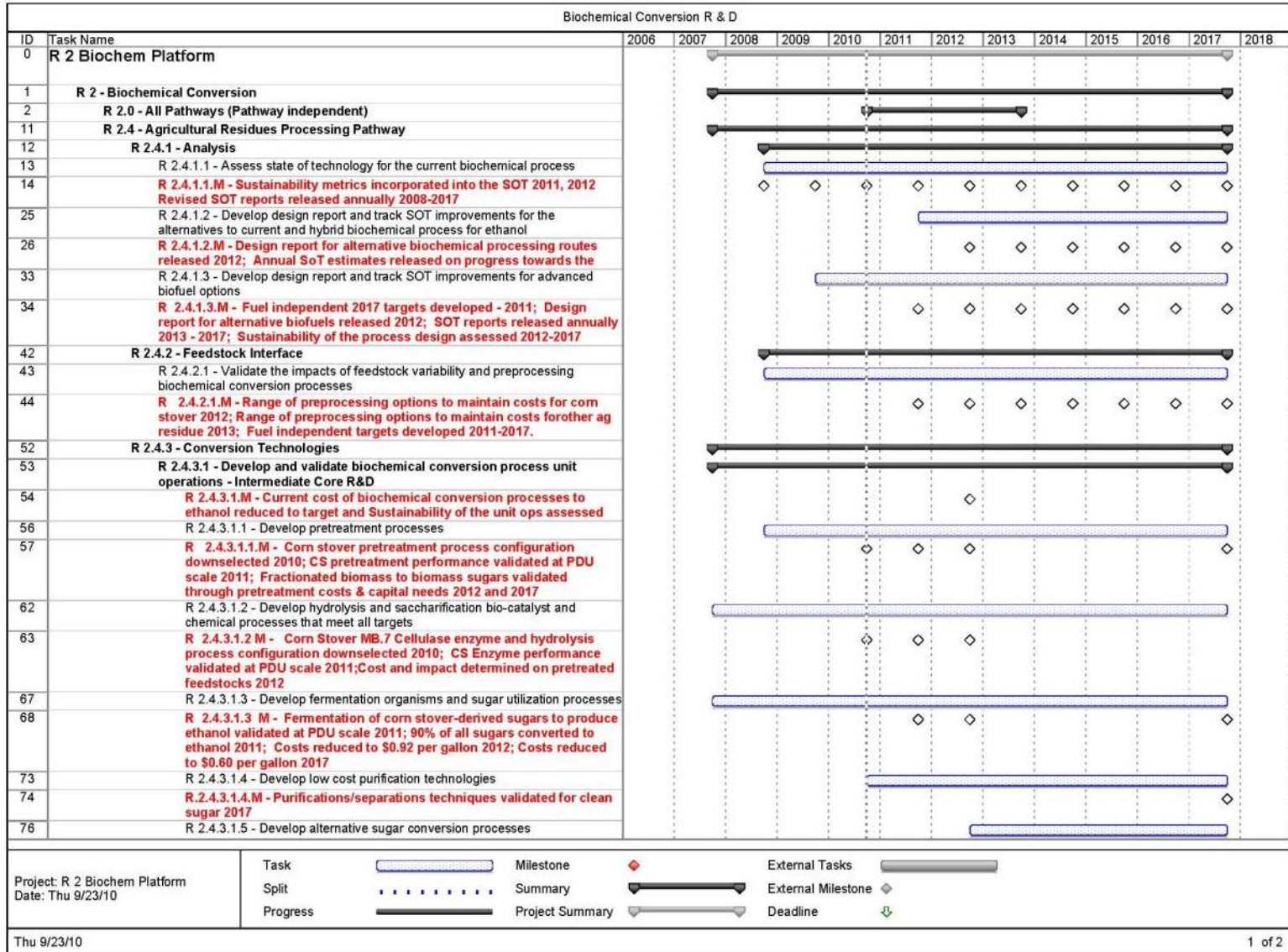

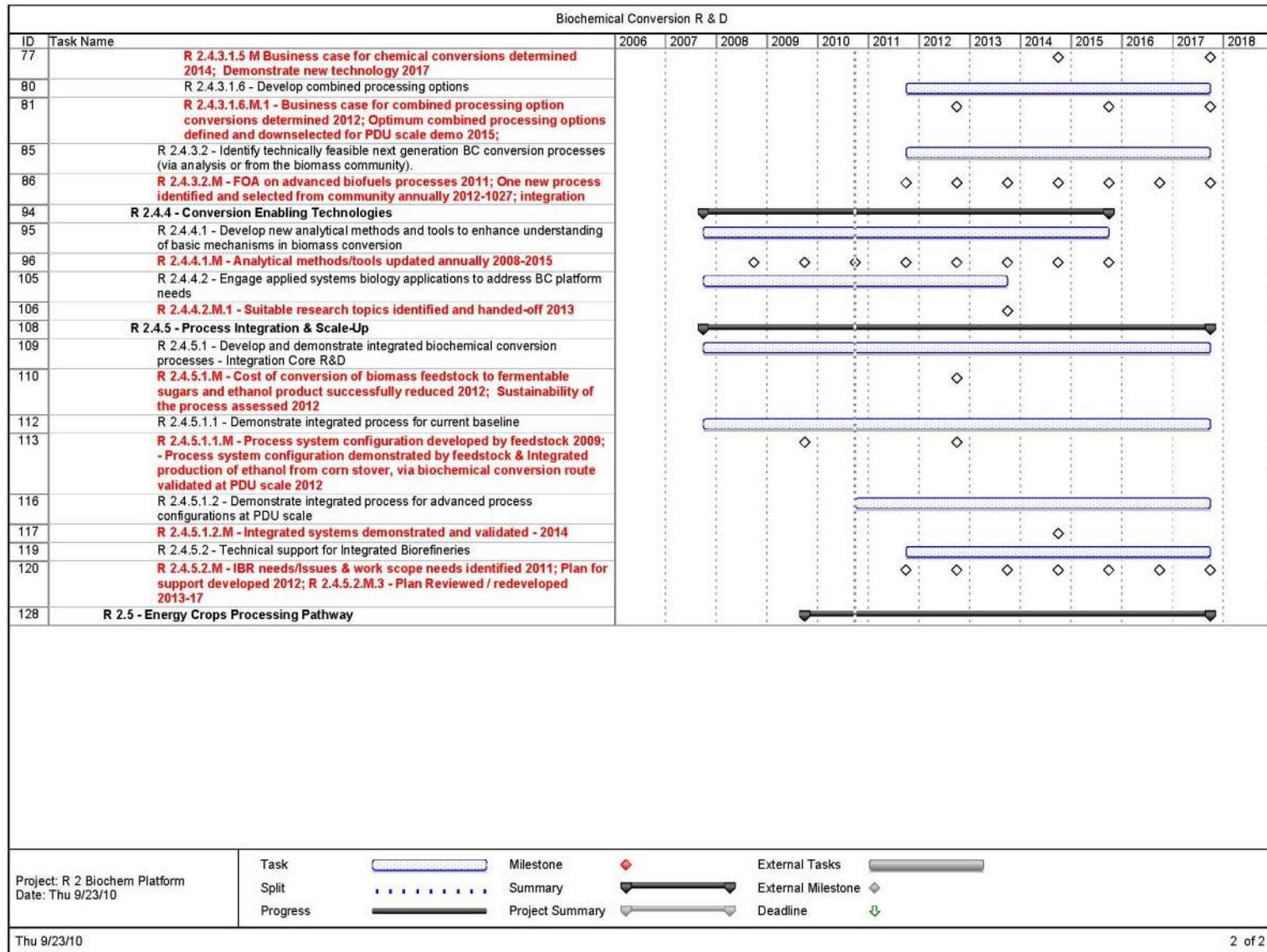

2.2.2 Thermochemical Conversion Research & Development

Thermochemical Conversion R&D develops technology to convert biomass to fuels, chemicals, and power via thermal and chemical processes such as gasification, pyrolysis, and other catalytic conversion processes. Intermediate products include clean synthesis gas (a mixture of primarily hydrogen and carbon monoxide, resulting from gasification), bio-oil (a liquid product from pyrolysis), bio-char (a solid product from pyrolysis), and gases rich in methane, ethane, or hydrogen. These intermediate products can then be upgraded to products such as ethanol, other alcohols, renewable gasoline, renewable diesel, renewable jet fuel, ethers, chemical products, or high-purity hydrogen, or maybe even used directly for heat and power generation. Some of these products are direct substitutes for fossil-fuel-based intermediates and products and are compatible with existing fossil fuel processing and distribution infrastructure.

Based on the current stage of development of thermochemical conversion technologies, gasification provides potential for near-term deployment, while pyrolysis will help to meet longer-term biofuels goals and in providing a route to renewable gasoline, diesel and jet fuel. Pyrolysis presents the additional benefit of leveraging investments in the petroleum industry since its intermediate product of bio-oil can, after stabilization and upgrading, be potentially used as a petroleum refinery feedstock.

Thermochemical conversion technology options can maximize biomass resource utilization to produce biofuels because they can more easily convert low-carbohydrate biomass materials such as forest and wood resources than the biochemical conversion options. In addition, they can convert the lignin-rich non-fermentable residues from biochemical conversion processes. Advanced conversion technology scenarios rely on considerable liquid fuel yield per ton of biomass and enable higher overall energy efficiencies by allowing integration of high-efficiency heat and power production systems.

Thermochemical Conversion Unit Operations

(i) **Gasification-to-Biofuels Conversion Process Description**

A simple thermochemical gasification process flow for converting biomass to biofuels is shown in Figure 2-15. Process details for a gasification route to mixed alcohols are available in design reports.⁹

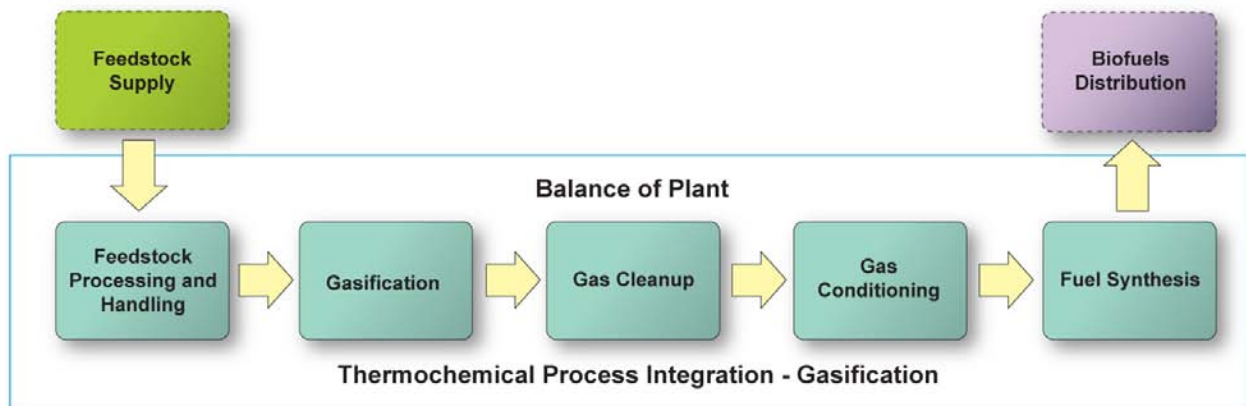

Figure 2-15: Thermochemical Gasification Route for Biomass to Biofuels

Feed Processing and Handling: The feedstock interface addresses the main biomass properties that affect the long-term technical and economic success of a thermochemical conversion process: moisture content, fixed carbon and volatiles content, impurity concentrations, and ash content. High moisture and ash content reduce the usable fraction of delivered biomass. Maximizing gasification system efficiencies thus requires dry, low-ash biomass; however, effective technologies for conversion of wet residues are also possible.

Gasification: Biomass gasification is a complex thermochemical process that begins with the thermal decomposition of a lignocellulosic feedstock. This is followed by partial oxidation or reforming of the fuel with a gasifying agent—usually air, oxygen, or steam—to yield raw syngas. The raw gas composition and quality are dependent on a range of factors, including feedstock composition, type of gasification reactor, gasification agents, stoichiometry, temperature, pressure, and the presence or lack of catalysts.

Gas Cleanup: Gas cleanup is the removal of contaminants from biomass-derived synthesis gas. It generally involves an integrated multi-step approach which varies depending on the intended end use of the product gas. However, gas cleanup normally entails removing or reforming tars and acid gas, ammonia scrubbing, capturing alkali metal, and removing particulates.

Gas Conditioning: Typical gas conditioning steps include sulfur polishing (to reduce levels of hydrogen sulfide to acceptable amounts for fuel synthesis) and water-gas shift (to adjust the final hydrogen-carbon monoxide ratio for optimized fuel synthesis).

Fuel Synthesis: The “cleaned and conditioned” synthesis gas composed of carbon monoxide and hydrogen in a given ratio can be converted to mixed alcohols or Fischer-Tropsch hydrocarbons. The production of fungible liquid transportation fuels from these intermediates also yields value-added bio-based byproducts and chemicals. Since the fuel synthesis step is exothermic, heat recovery is essential to maximize the process efficiency.

Balance of Plant: This encompasses the entire site and its need for integrated and effective energy, heat, steam, and water usage. Pinch analysis is used to analyze the energy network of the process and optimize energy integration of the process. Cost reductions are attained through better usage of waste heat stream.

(ii) Pyrolysis and Biofuels Conversion Process Description

A simple pyrolysis process for converting biomass to renewable gasoline, jet fuel, or diesel is shown in Figure 2-16 below. Process details for the pyrolysis of wood chips and subsequent hydrotreating and hydrocracking to produce renewable gasoline, jet fuel, and diesel are available in a recent design report.¹⁰

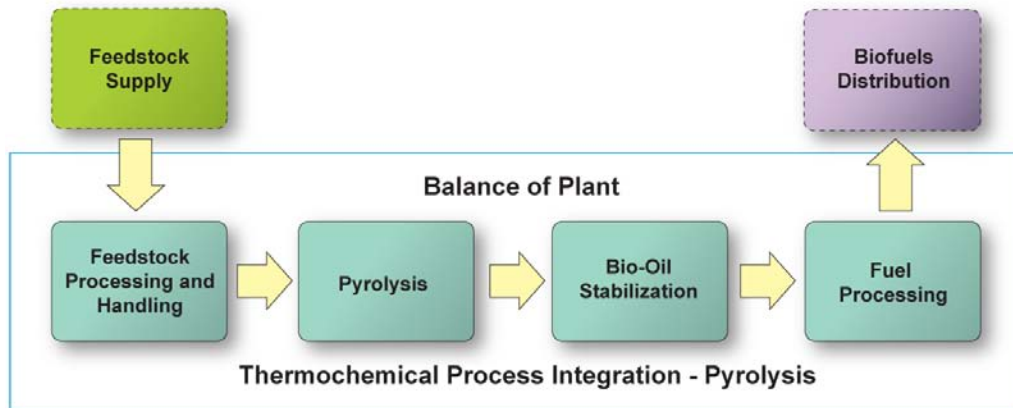

Figure 2-16: Thermochemical Pyrolysis Route for Biomass to Biofuels

Feed Processing and Handling: Similar to gasification, the feedstock interface for pyrolysis addresses the main biomass properties that affect the long-term technical and economic success of a thermochemical conversion process: moisture content, elemental composition, impurity concentrations, particle size, particle porosity, and ash content. High moisture and ash content reduce the usable fraction of delivered biomass. So-called “fast” pyrolysis processes require dry feedstocks, while hydrothermal approaches can use moist biomass.

Pyrolysis: Pyrolysis is the thermal decomposition of biomass in the absence of oxygen to produce a bio-oil intermediate that superficially resembles No. 4 fuel oil. Fast pyrolysis reactions occur at lower reaction temperatures than gasification and produce primarily liquid products together with some gases and bio-char. Several types of fast pyrolysis or hydrothermal processes can be used to produce bio-oils, and their characteristics such as oxygen content, water content, or viscosity depend on the processing conditions.

Bio-Oil Cleanup and Stabilization: Cleanup and stabilization of the bio-oil converts it into a liquid intermediate that can be stored for a minimum of 6 months. Cleanup consists of removing water, particulates, and ash by filtration and similar methods. Stabilization involves preliminary hydrotreating and similar thermal and catalytic processing to reduce the total oxygen content of the intermediate and its acid content in order to reduce reactivity.

Fuel Processing: Additional processing of the bio-oil is required to enable bio-oil to become a feedstock suitable for use in a petroleum refinery at several entry points. Hydrocracking processes convert the feedstock to renewable gasoline, jet fuel, and diesel using modified technologies employed by existing refiners. This processing leverages the economies of scale and the investments of the petroleum industry and provides biofuel alternatives.

Balance of Plant: This encompasses the entire site and significant contributions are derived from the hydrogen generation and air- and water-operation. Cost reductions are attained through more efficient hydrogen usage and better usage of power and water.

Thermochemical Conversion Interfaces

Feedstock Interface: Feedstock Logistics R&D provides preprocessed feedstock that meets the requirements (composition, quality, size, moisture content, etc.) as defined by the specific thermochemical conversion process configuration. Close coordination between Feedstock Logistics and Thermochemical Conversion R&D is required to supply adequate feedstock in an appropriate quality and form to the biorefinery.

Biofuels Distribution Infrastructure Interface: The next step in the biomass-to-biofuels supply chain is the distribution of the biofuels produced. Thermochemical Conversion R&D provides information about physical properties, reactivities, and compatibilities of intermediates and biofuels to the distribution infrastructure and end use technology area while working to understand and specify requirements and limitations of distribution infrastructure and end use on the biofuels and intermediates being developed.

2.2.2.1 Thermochemical Conversion R&D Support of Program Strategic Goals

The Thermochemical Conversion R&D strategic goal is to *develop technologies for converting feedstocks into cost-competitive commodity liquid fuels, such as ethanol, renewable gasoline, jet fuel, and diesel, as well as bioproducts and biopower.*

Thermochemical Conversion R&D directly addresses and supports production of fuels from forest resources, dry sorted municipal solid waste, energy crops, and agricultural residue pathways. It also indirectly supports the production of bioproducts from these pathways. Thermochemical conversion technologies provide options for improving the economic viability of the developing bioenergy industry by their ability to convert whole biomass as well as the fractions of the biomass resources that are not amenable to biochemical conversion technologies (e.g., lignin-rich process residues and other low-carbohydrate feedstocks or process intermediates). Biomass Program is also currently examining the use of thermochemical conversion technologies for the conversion of algae and algal oils to biofuels.

2.2.2.2 Thermochemical Conversion R&D Support of Program Performance Goals

Thermochemical Conversion R&D has two overall performance projections corresponding to the primary gasification and pyrolysis processing routes. Each process will reduce the estimated mature technology processing cost^{*} for converting cellulosic feedstocks to advanced biofuels:

- By 2012, the gasification-to-ethanol process will achieve a conversion cost of \$0.86 per gallon of ethanol[†] (\$1.28/GGE, 2007\$).
- By 2017, a biomass-based thermochemical route that produces gasoline and diesel blendstocks will achieve a conversion cost of \$1.56 per gallon of total blendstock (\$1.47/GGE, 2007\$), as shown in Appendix B, Table B-7.

^{*} Estimated mature technology processing cost means that the modeled capital and operating costs are assumed to be for an “nth plant” where several plants have been built and are operating successfully so that additional costs for risk financing, longer startups and under performance, and other costs associated with pioneer plants are not included

[†] See Figure 3.19 for additional information.

Feedstock pathway performance goals for the pathways under investigation are as follows:

- By 2012, (Q4), validate integrated conversion process to produce ethanol from syngas via gasification of woody feedstocks at a scale sufficient enough for transfer to pilot-scale operation.
- By 2015, (Q4), validate integrated conversion process for woody biomass to renewable gasoline or diesel via pyrolysis at a scale sufficient enough for transfer to pilot-scale operation.
- By 2017, (Q4), validate fully integrated conversion process for woody biomass to renewable gasoline or diesel via pyrolysis at a scale sufficient enough for transfer to pilot-scale operation.

2.2.2.3 Thermochemical Conversion R&D Technical Challenges and Barriers

Tt-A. Feeding Dry Biomass: In the near term, there are no significant barriers to feeding and handling dry wood or dry energy crop resources in atmospheric systems, provided they are of a relatively uniform particle size and chemical composition. In the longer term, there is a need for improvements in the processing and feeding of dry biomass including densification, logistics of handling, development of specifications, and removal of problematic chemical contaminants. Demonstrating reliable feeding of dry biomass into pressurized systems is also needed.

Tt-B. Feeding or Drying Wet Biomass: There is a need to understand the costs and trade-off for drying or feeding wet biomass feedstocks such as green biomass or wet lignin-rich fermentation residues. Innovative dryer designs capable of utilizing low-value process heat will be important to the integrated biorefinery.

Tt-C. Gasification of Biomass: There is a need to understand the chemistry and physical handling properties of biomass feedstocks, minor byproducts and co-products, and biorefinery residual solids. This includes developing an understanding of gasification options and their chemistries for materials including wood, energy crops, sorted municipal solid waste, agricultural residues high in minerals and lignin, and high-moisture organic residues.

Tt-E. Pyrolysis of Biomass and Bio-Oil Stabilization: The pyrolysis of biomass has been studied for some time, however, the resulting bio-oil is unstable and highly reactive. Improvements in pyrolytic processing—with or without catalysts—are needed to yield higher quality bio-oil that will lower subsequent upgrading costs and allow for greater commercial viability. New methods and catalysts to clean and stabilize the bio-oil are needed to ensure the product is less reactive and stable for at least of six months; these advances include improved catalysts for deoxygenation and techniques for removal of solids from bio-oil.

Tt-F. Syngas Cleanup and Conditioning: There is a near-term need for gas cleaning and conditioning catalysts and technology that can cost-effectively remove contaminants such as tars, particulates, alkali, and sulfur. The interactions between the catalysts used for gas cleanup and conditioning, and the gasification conditions and feedstock are not well understood. These interactions require careful attention to trace contaminants and are important for efficient cleanup and conditioning of syngas in conjunction with optimal lifetimes of the catalyst(s).

Tt-G. Fuel Synthesis and Upgrading:

Gasification Route – The commercial success of mixed alcohol synthesis or hydrocarbon liquids has been limited by poor selectivity and low product yields. More robust catalysts with increased productivity and selectivity with a biomass feedstock together with extended lifetimes are required to enable viable capital and operating costs.

Pyrolysis Route – There is a need for hydrotreating and hydrocracking catalysts that are highly selective to the desired end product, robust with respect to the bio-oil (pyrolysis oil) impurities, and have high conversion rates and long lifetimes. The development of robust catalysts for upgrading and hydrotreating bio-oils to produce liquid transportation fuels is vital for the success of these processes. Bio-oils may be upgraded to different levels, allowing several entry points to a petroleum refinery.

Tt-H. Validation of Syngas Quality: Syngas quality specifications for production of liquid fuel products like methanol/dimethyl ether, methylal, mixed alcohols and hydrocarbon liquids are reasonably well known. However, validation that syngas from biomass can meet the rigorous quality specifications needed for the production of liquid fuels via catalytic synthesis is still needed.

Tt-I. Sensors and Controls: Effective process control will be needed to maintain plant performance and regulate emissions at target levels with varying load, fuel properties, and atmospheric conditions. Commercial control systems need to be developed and tested for thermochemical processes and systems.

Tt-K. Thermochemical Process Integration: Thermochemical conversion technologies process integration currently presents large scale-up risks because of lack of high quality controlled process data on integrated systems over extended periods of time that would be required of industrial operations. The effect of feed and process variations throughout the process must be understood to ensure robust and efficient operation of biorefineries. Process integration work is essential for characterizing the complex interactions that exist between many of the processing steps; identifying impacts of trace components on catalytic and thermal systems; and enabling the generation of predictive engineering models that can guide process optimization and scale up.

2.2.2.4 Thermochemical Conversion R&D Approach for Overcoming Challenges and Barriers

The Thermochemical Conversion technology area's approach for overcoming the above mentioned technical challenges and barriers is outlined in its R&D work breakdown structure (WBS) shown in Figure 2-17. Thermochemical conversion R&D is organized around five key areas: Analysis, Feedstock Interface, Conversion Technologies, Conversion Enabling Technologies, and Integration and Scale-Up.

Near-term R&D efforts focus on gasification of woody biomass to ethanol, however, agricultural residues, dry sorted municipal solid waste, and later energy crops may also be examined. Mid-term efforts focus on fast pyrolysis of woody biomass as well as other feedstocks for the production of renewable gasoline, diesel and jet fuel. Longer-term new conversion process alternatives will consider all appropriate feedstocks for the production of renewable gasoline, diesel and jet fuel. Research on these key focus areas is performed by national laboratories,

industry, and universities, as well as in the National Advanced Biofuels Consortium established under the American Recovery and Reinvestment Act of 2009.

The Thermochemical R&D WBS structure illustrated in Figure 2-17 is described below. Table 2-5 summarizes each task element's work as it relates to specific R&D barriers and biorefinery pathways.

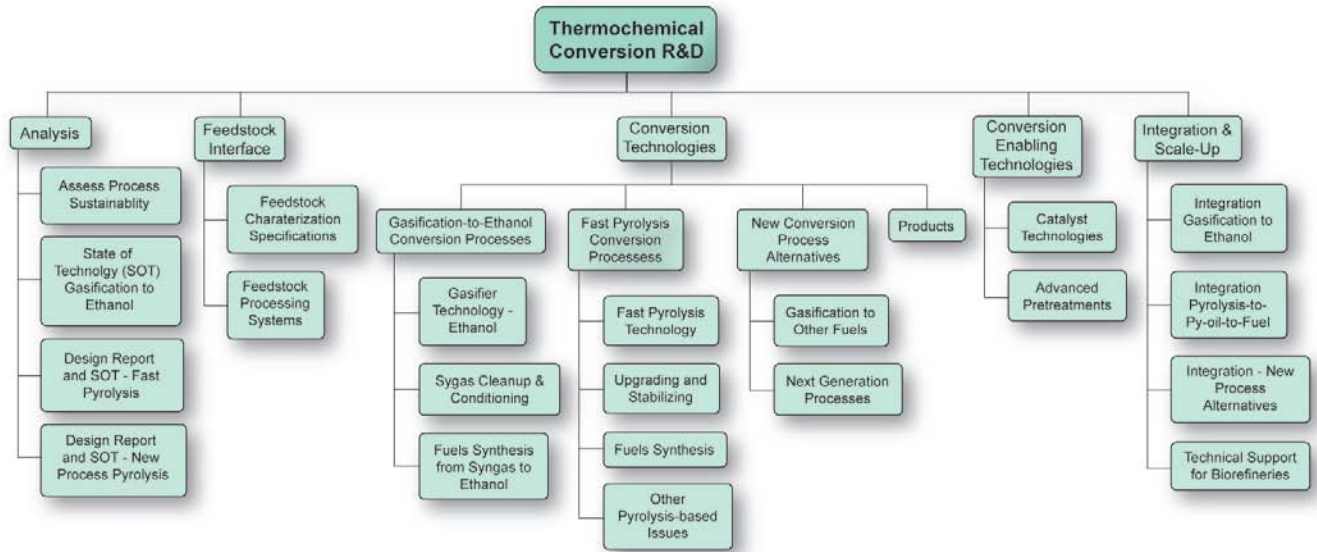

Figure 2-17: Work Breakdown Structure for Thermochemical R&D

Analysis (Barriers St-C, St-D, Tt-K)

Develop integrated conversion process designs, assess techno-economic feasibility and progress, and evaluate sustainability / lifecycle impacts for each feasible conversion technology process route, including gasification to ethanol, fast pyrolysis to hydrocarbon-based biofuels, or other new and emerging conversion processes. Experimental data is obtained and analyzed annually to monitor progress and direct future research efforts.

Feedstock Interface (Barriers Tt-A, Tt-B)

For biorefineries, it is important that feedstock specifications be met while feedstock processing requirements are minimized to reduce costs. Specifically, the key challenges will be to efficiently transport and handle a high moisture content material, economically dry biomass from 50 wt % moisture content to less than 30 wt % moisture content, and reduce ash content of the feedstock. This requires balancing the cost of plant-gate feedstock with the handling and processing required for reliable operation. Research activities also encompass handling, processing, and feeding that occur within the biorefinery plant boundaries. Relevant feedstock interface R&D for the production of biofuels may also be utilized by biopower technologies.

Conversion Technologies (Barriers Tt-C, Tt-E, Tt-F, Tt-G)

In order to fully realize the benefits of an integrated biorefinery, robust and cost-effective biomass thermal conversion processes are under development that can convert a variety of biomass materials to suitable clean and high quality intermediates for subsequent conversion to biofuels or biopower. Thermochemical conversion R&D on pretreatment and conversion processes may also be further developed for use with biopower technologies.

Gasification research through 2012 includes R&D into fundamental kinetic measurements, micro-activity catalyst testing, bench-scale thermochemical conversion studies, pilot-scale validation of tar-reforming catalyst performance, mixed alcohol catalyst development, demonstration of integrated biomass gasification mixed alcohol synthesis, and Fischer-Tropsch liquids synthesis at a scale sufficient to enable transfer to pilot-scale operation. Fast pyrolysis includes basic studies of catalytic and chemical mechanisms for improving yields and quality of bio-oils, advanced filtration of bio-oils, corrosion studies of arrays of bio-oils, catalytic deoxygenation of bio-oils, and development of catalysts for hydrotreating of bio-oils to biofuel suitable for blending stocks with petroleum-derived fuels.

As 2012 Thermochemical Conversion R&D target accomplishment nears, a down-selection will be made to the most promising new conversion technologies from among the technologies currently under investigation. These include but are not limited to: i) catalytic pyrolysis, ii) gasification to yield an oxygenate intermediate which is subsequently converted to biofuels, iii) hydrolysis, iv) gasification to yield longer carbon chain alcohols, and/or ethers, v) hydrothermal liquefaction. All these technologies yield biofuels other than ethanol, predominantly producing renewable gasoline, diesel, and jet fuel.

Conversion Enabling Technologies (Barriers Tt-C, Tt-E, Tt-F, Tt-G)

The need for development of the next generation of catalysts for conversion and conditioning of both biomass and intermediates, and subsequent synthesis of biofuels is critical in the advancement of biomass processing technology. Advancing both the measurement and understanding of catalyst activities, selectivities and deactivation processes, and gaining insights into the synergistic roles of elemental species within the active catalytic sites will enable development of new processes that are more energy-, carbon- and cost-efficient. Complementary to the enabling technology of catalysis is advances in the biomass pretreatment technologies that will improve feedstock logistics and the accessibility of the biomass molecular moieties to subsequent conversion processes. Advanced pretreatment will enable greater yield and quality of biomass intermediates and biofuels, and thus improved energy efficiency.

Integration & Scale-Up (Barriers Tt-A, Tt-B, Tt-C, Tt-E, Tt-F, Tt-G, Tt-H, Tt-I, Tt-K)

Investigating thermochemical conversion technologies together with downstream fuel synthesis identifies the issues and opportunities in integration and scale-up. In addition, the effect of feed and process variations throughout the process must be understood to ensure robust, optimally controlled, efficient biorefineries. Immediate goals include demonstrating that improved tar cracking and reforming catalysts have opportunities for process intensification and utilizing the synergies between synthesis gas conditioning and mixed alcohols synthesis for a pathway with reduced cost and risk of gasification-based process technology. Process intensification and advanced process control can drive the economics by significantly reducing capital and operating costs, thus minimizing the overall production costs. As thermochemical conversion technologies get proven, findings are communicated for integration into new and existing biorefineries. The Program leverages industry feedback to understand emerging issues and R&D opportunities while also supporting the Program's Integrated Biorefineries technology area by identifying needs for integrated projects and providing synergistic R&D that is limited to unit operations.

Table 2-5: Thermochemical R&D Activity Summary

Goal: Develop technologies for converting feedstocks into cost-competitive commodity liquid fuels, such as ethanol, renewable gasoline, renewable jet fuel, and renewable diesel, as well as bioproducts and biopower.				
WBS Element	Description	FY2010 Performer	Barrier(s) Addressed	Pathway(s) Addressed *
Analysis	Develop integrated conversion process designs, assess techno-economic feasibility and progress, and evaluate sustainability / life cycle impacts - Gasification to Ethanol Conversion Route - Fast Pyrolysis Conversion Route - New Conversion Process Alternatives	NREL PNNL	St-C: Sustainability Data, St-D: Sustainability Indicators and Methodology; Tt-K Thermochemical Process Integration	<ul style="list-style-type: none"> • Agricultural Residues Processing • Energy Crops Processing • Forest Resources Processing • Waste Processing
Feedstock Interface	Develop feedstock specifications and processing systems that accommodate feedstock variability and optimize conversion processes - Mechanically, and chemically characterize the feedstocks and develop optimal feedstock and blending specifications - Develop feedstock processing systems for optimal yields and selectivity	INL; ORNL	Tt-A: Feeding Dry Biomass, Tt-B: Feeding or Drying Wet Biomass	
Conversion Technologies	Research and development into most promising technology routes based on techno-economic analysis and preliminary investigation into new emerging routes - Develop Gasification to Ethanol Conversion Processes including gasifier technology, syngas cleaning and conditioning, and fuel synthesis systems - Develop Fast Pyrolysis Conversion Processes including pyrolysis oil upgrading and stabilizing and fuel synthesis systems - Develop new conversion process alternatives such as Hydrothermal Liquefaction, Wet Gasification, or Lipid-reforming processes - Develop Conversion to Products	NREL; PNNL; Emery Energy Company; Iowa State University; Research Triangle Institute; Southern Research Institute; Purdue University; University of Massachusetts Amherst; Virginia Polytechnic Institute; Excelus, Inc.;NABC	Tt-C: Gasification of Biomass, Tt-F: Syngas Cleanup and Conditioning, Tt-G: Fuels Catalyst Development, Tt-H: Validation of Syngas Quality, Tt-I: Sensors and Controls; Tt-E: Pyrolysis of Biomass and Bio-Oil Stabilization	
Conversion Enabling Technologies	Enhance existing enabling technologies, investigate non-route-specific promising unit operations improvements and develop non-route-specific conversion technologies - Develop catalyst technologies for conversion beyond ethanol, to improve catalyst life and function - Investigate and develop pretreatment enhancement to downstream yields	NREL; Excelus, Inc.; Emery Energy Company; Iowa State University; Research Triangle Institute; Southern Research Institute	Tt-F: Syngas Cleanup and Conditioning; Tt-E: Pyrolysis of Biomass and Bio-Oil Stabilization; Tt-G: Fuels Catalyst Development; Tt-I: Sensors and Controls	
Process Integration and Scale-Up	Integrate unit operations and scale up to reduce cost of sustainable biomass conversion to fuels - Integrate gasification to ethanol Unit Operations - Fully integrate pyrolysis to py-oil-to-fuel system - Fully integrate other emerging TC process alternatives - Identify needs of IBR projects and provide limited unit operations focused research and development to enable successful performance	NREL PNNL	Tt-A: Feeding Dry Biomass, Tt-B: Feeding or Drying Wet Biomass; Tt-C: Gasification of Biomass Tt-E: Pyrolysis of Biomass and Bio-Oil Stabilization; Tt-F: Syngas Cleanup and Conditioning, Tt-G: Fuels Catalyst Development, Tt-H: Validation of Syngas Quality, Tt-I: Sensors and Controls, Tt-K: Thermochemical Process Integration	

* Denotes primary feedstock pathway under investigation

2.2.2.5 Prioritizing Thermochemical Conversion R&D Focus

In order to achieve the Thermochemical Conversion R&D goals, all of the challenges and barriers need to be addressed. However, the following three high impact research areas with engineering and/or catalysts as critical aspects to R&D success are:

- Quality of biomass intermediates (syngas or bio-oil)
- Fuels synthesis from bio-oil and from syngas
- Reactor process optimization

Thermochemical Conversion R&D has prioritized its efforts in overcoming technical barriers based on techno-economic analysis. The analysis results for the gasification route are illustrated in Figure 2-18 and for the pyrolysis route in Figure 2-19.

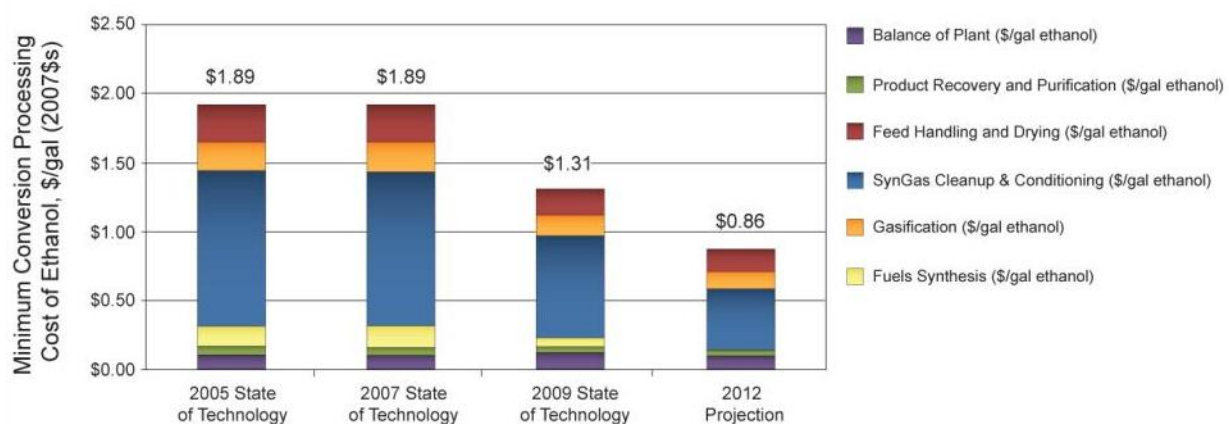

	2005 State of Technology	2007 State of Technology	2009 State of Technology	2012 Projection
Processing Total (\$/gal ethanol)	\$ 1.89	\$ 1.89	\$ 1.31	\$ 0.86
Balance of Plant (\$/gal ethanol)	\$ 0.11	\$ 0.11	\$ 0.12	\$ 0.10
Product Recovery and Purification (\$/gal ethanol)	\$ 0.06	\$ 0.06	\$ 0.05	\$ 0.05
Fuels Synthesis (\$/gal ethanol)	\$ 0.15	\$ 0.15	\$ 0.07	\$ (0.01)
SynGas Cleanup & Conditioning (\$/gal ethanol)	\$ 1.13	\$ 1.13	\$ 0.74	\$ 0.44
Gasification (\$/gal ethanol)	\$ 0.21	\$ 0.21	\$ 0.15	\$ 0.13
Feed Handling and Drying (\$/gal ethanol)	\$ 0.27	\$ 0.27	\$ 0.19	\$ 0.16

Note: Please see footnote on Table B6 in Appendix B for comments on rounding of numbers and subsequent summation.

Figure 2-18: Thermochemical Conversion of Woody Feedstocks to Ethanol (\$/gal in 2007\$) via Gasification

Figure 2-18 shows that a total potential reduction in conversion cost of 55% can be achieved with improvements in all six areas. R&D activities are focused to impact this cost. The status and targets are based on gasification of woody feedstocks, syngas cleanup, and mixed alcohol synthesis and recovery. The State of Technology status and projection is a modeled production cost at 2,000 dry tons feedstock/day of an nth plant using programmatic data from the thermochemical gasification conversion R&D. Information on the technical performance

projections that form the basis for the gasification conversion system designs and cost estimates are provided in Appendix B, Table B-5. After 2012, R&D on gasification of biomass to ethanol will have been completed and R&D efforts would be refocused toward new conversion process alternatives that offer pathways to meeting the 2017 program performance goals.

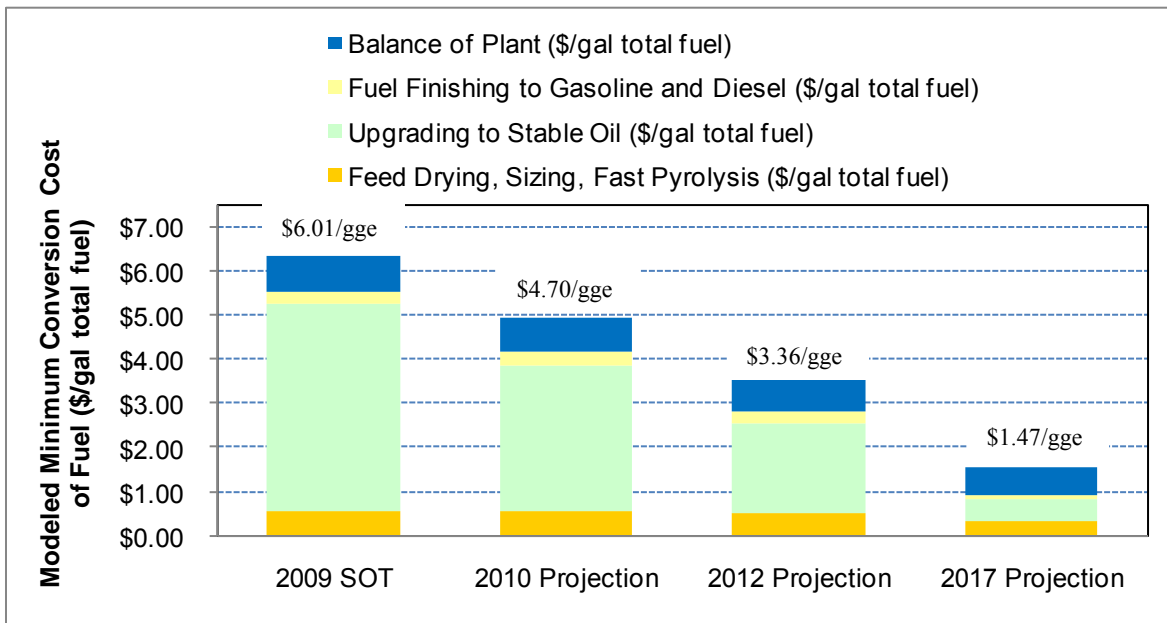

	2009 SOT	2010 Projection	2012 Projection	2017 Projection
Conversion Contribution (\$/gal gasoline)	\$6.30	\$4.92	\$3.51	\$1.56
Conversion Contribution (\$/gal diesel)	\$6.37	\$4.99	\$3.57	\$1.56
Conversion Contribution (\$/gge total fuel)	\$6.01	\$4.70	\$3.36	\$1.47
Feed Drying, Sizing, Fast Pyrolysis (\$/gal total fuel)	\$0.54	\$0.53	\$0.52	\$0.34
Upgrading to Stable Oil (\$/gal total fuel)	\$4.69	\$3.34	\$2.01	\$0.47
Fuel Finishing to Gasoline and Diesel (\$/gal total fuel)	\$0.30	\$0.30	\$0.29	\$0.11
Balance of Plant (\$/gal total fuel)	\$0.80	\$0.79	\$0.72	\$0.65

Figure 2-19: Thermochemical Conversion of Woody Feedstocks to Renewable Gasoline and Diesel Blend Stocks (\$/gallon gasoline in 2007\$) via Pyrolysis

Figure 2-19 shows that a total potential reduction of 75% can be achieved with improvements in all four areas. R&D activities are focused to impact this cost. Please note that by 2013, additional information on level of upgrading and different insertion points of bio-oils into a petroleum refinery is anticipated, together with knowledge available from the National Advanced Biofuels Consortium. In 2013, design cases for fast pyrolysis to biofuels will be re-examined to ensure the optimal cost-, carbon-, and energy-efficient process is chosen.

The SOT projections are based on pyrolysis of woody feedstocks, bio-oil stabilization, and fuel finishing to gasoline and diesel. The projections are modeled production costs at 2,000 dry tons feedstock/day of an nth plant using the available literature data and experimental data from PNNL for bench-scale fast pyrolysis and subsequent hydrotreating R&D. Initial summary information on the technical performance projections for the pyrolysis conversion system design is provided in Appendix B, Table B-6.

2.2.2.6 Thermochemical Conversion R&D Milestones and Decision Points

The key Thermochemical Conversion R&D milestones, inputs/outputs, and decision points to complete the tasks described in [Section 2.2.2.4](#) are summarized in the chart in Figure 2-20.

Figure 2-20: Thermochemical Conversion R&D Gantt

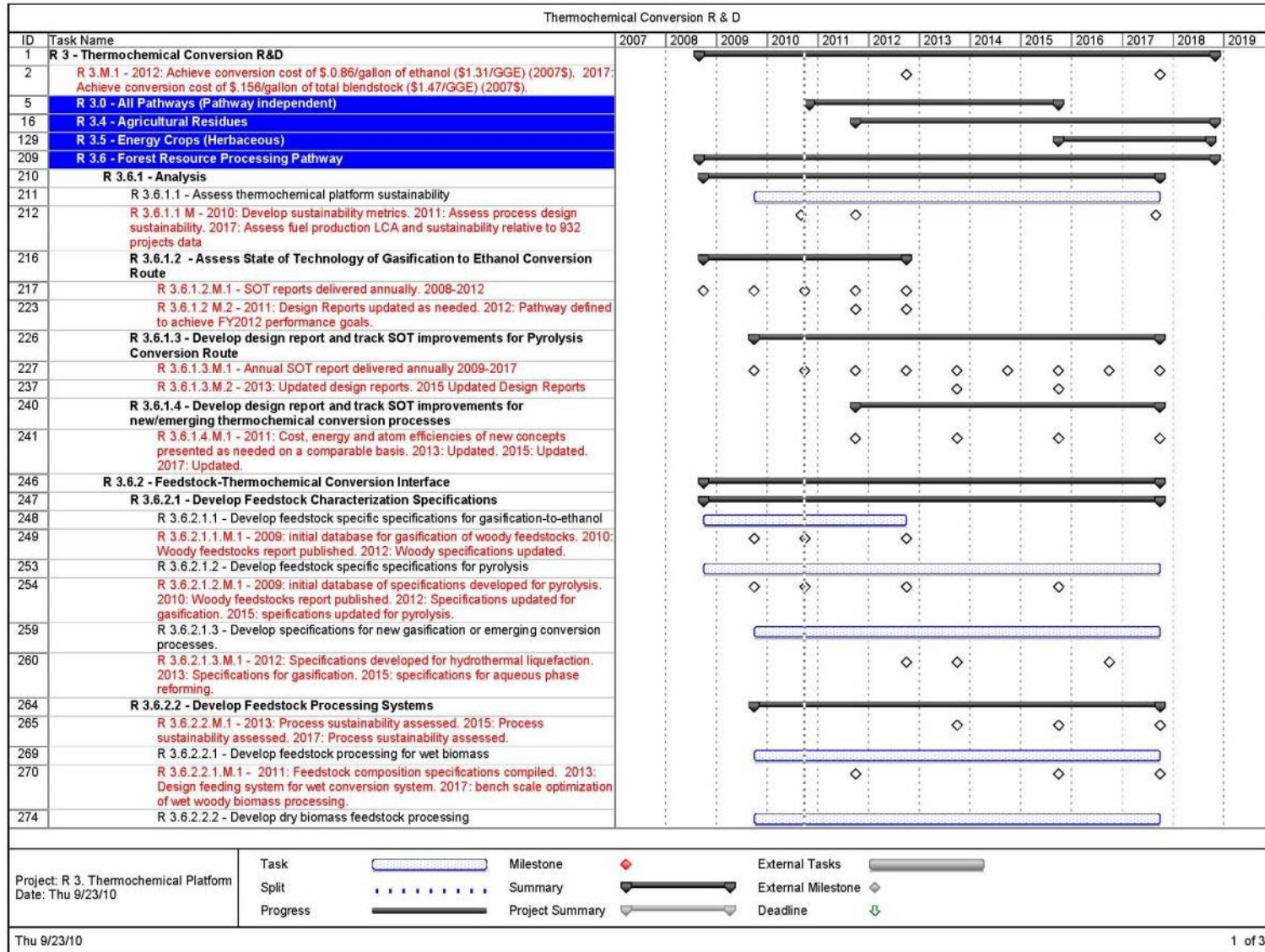

Thermochemical Conversion Research & Development

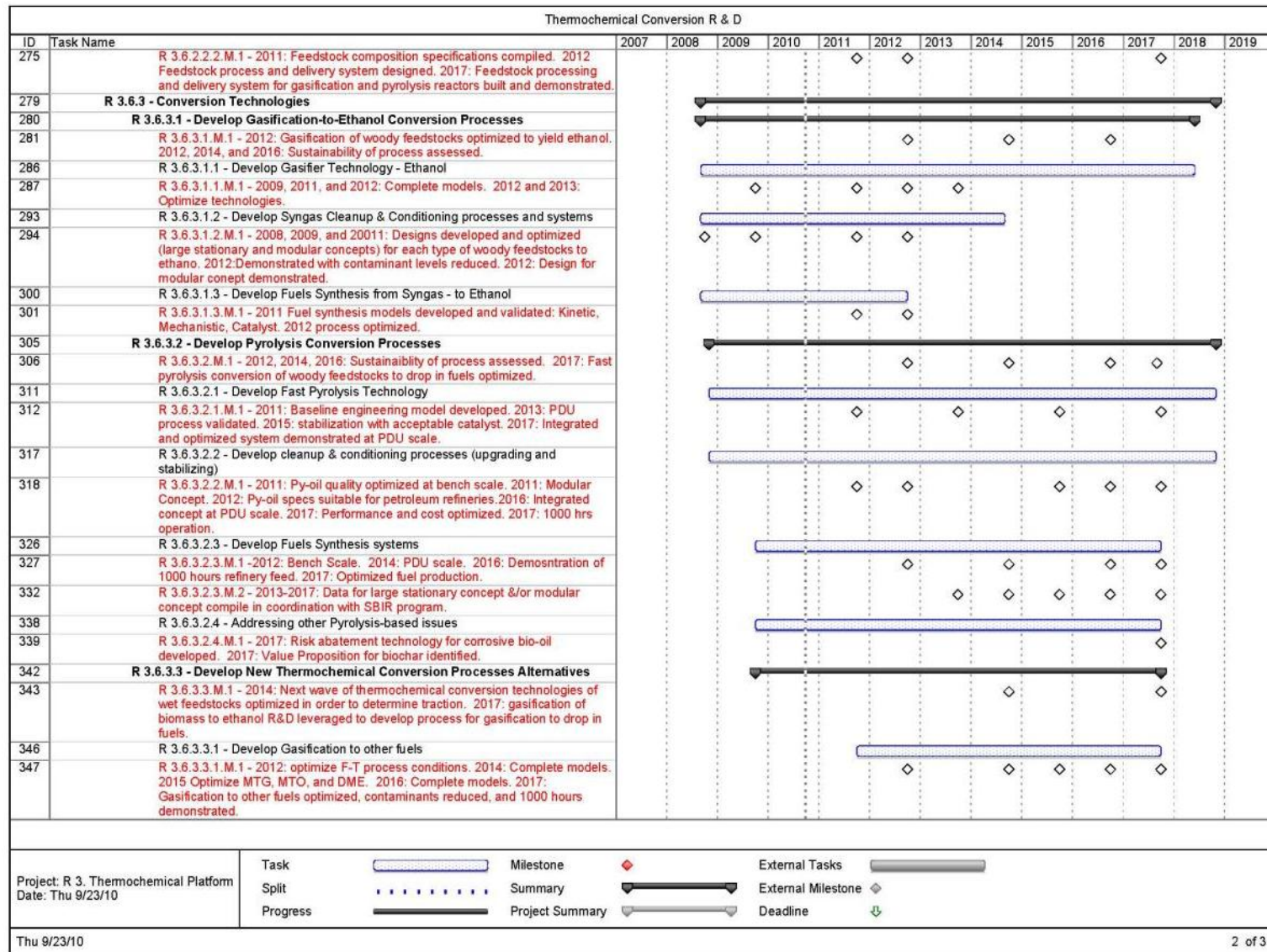

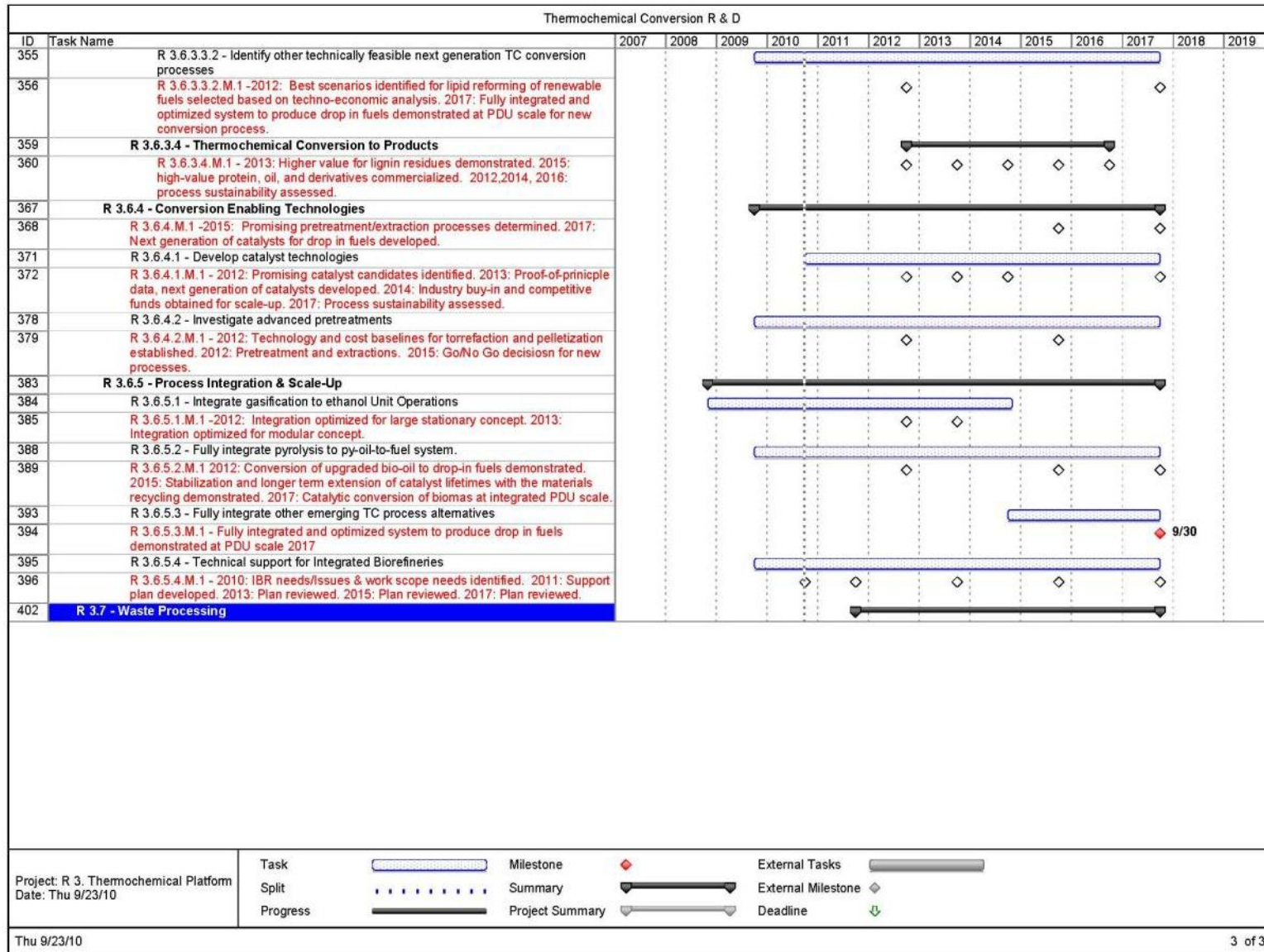

2.3 Integrated Biorefineries

The role of the Integrated Biorefineries (IBR) technology area is to demonstrate and validate cost and performance data for various biofuel conversion pathways through building and operation of pilot-, demonstration- and commercial-scale integrated biorefineries by public-private partnerships. IBR is focused on resolving key issues involved in the scale-up of integrated biorefinery systems. These projects will help overcome barriers, promote commercial acceptance, ultimately reducing risk for private sector financing of follow-on plants.

The activities of IBR contribute to all of the biorefinery pathways. The Biomass Program is committed to completing the construction and operation of pilot-, demonstration- and first-of-a-kind commercial-scale projects that convert biomass into advanced biofuels. The cost-shared partnerships are essential to bridging the “valley of death” between R&D and commercial deployment of renewable biofuels technologies.

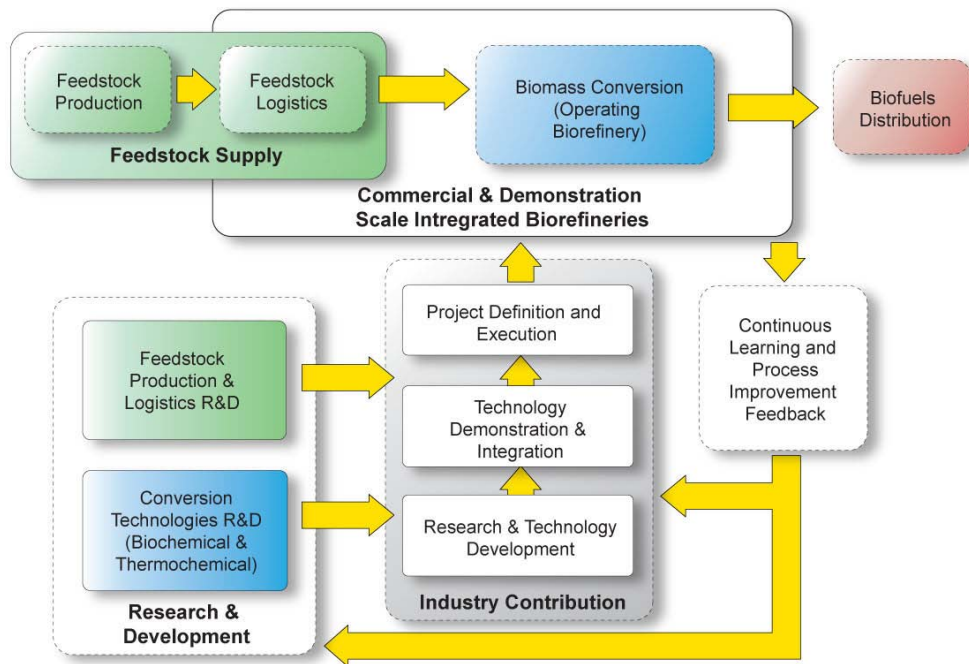

Figure 2-21: Integrated Biorefineries Technology Area Scope and Connection to R&D Efforts

Integrated Biorefinery Stages of Development

The stages described below outline the various activities involved in biorefinery development and project management of the integrated biorefinery projects (Figure 2-21).

Scales of Biorefinery Development

Technology integration and validation at the pilot scale verifies the performance of the given suite of technologies from both a technical and an economic perspective. Integrated pilot-scale validation is essential in identifying flaws that must be corrected for a successful commercial

launch. If these potential problems are not corrected or remain unidentified, it is unlikely that a plant will achieve its design capacity, operability factor, and/or profitability. Integrated pilot testing is also instrumental in generating the performance data and equipment specifications required to design a demonstration-scale facility. Successful integrated piloting will strengthen projects in their later demonstration stages and encourage private investment.

Technology validation at the demonstration scale verifies the performance of the given suite of technologies from both a technical and an economic perspective at a scale sufficient to provide the performance data and equipment specifications required to design a commercial-scale facility. A demonstration-scale facility is generally considered to be between 1/50th to 1/10th of the scale of the envisioned commercial facility. Technology validation at the demonstration scale confirms that industrial-scale components can be incorporated into a complete system and that system performance and operational requirements meet design specifications. To determine if a project is ready for demonstration scale, integrated pilot testing of all critical process steps must be successfully completed.

First commercial-scale deployment refers to a first-of-a-kind or “beta” commercial facility. The successful design, construction, and operation of a first-of-a-kind commercial facility is dependent on the prior development of a functional, fractional-scale demonstration plant that can generate the performance data and equipment specifications required to design a full-scale commercial facility. To determine if a project is ready for scale up to commercial operation, integrated pilot- and demonstration-scale data should be analyzed. Once there is a commercial-scale facility that achieves design specifications and positive cash flow, the technology application can be replicated.

These follow-on plants would be eligible for traditional project financing from investment bankers.

Integrated Biorefinery Project Management Activities

Project definition includes developing a detailed facility design coupled with mass and energy balances that identify technical uncertainties or issues that have not been resolved. In these cases, additional R&D and piloting may be required before the project can continue. Facility permitting is a long, iterative process and should be initiated during this stage.

Project execution includes facility construction, pre-commissioning, commissioning, and performance acceptance testing at the pilot, demonstration and commercial scale. Some design flaws may not be identified until startup, which can lead to a wide range of training, equipment, or design issues. The overall duration of construction, commissioning, and startup is tied to the scale and complexity of the facility design, and in certain cases may last several years. Failure to get through the commissioning and subsequent performance acceptance tests in a timely fashion may result in project failure. The availability of integrated pilot performance data, combined with properly executed process design and facility engineering, can help reduce risk and increase the likelihood of success.

Project Management Plans enable the Biomass Program to monitor the implementation of the IBR projects. The Project Management Plan includes the development of a “Baseline” scope, budget, and schedule that meets the following criteria:

- Demonstrates appropriate project management practices will be fully integrated with financial and business systems to measure project progress and enhance the probability of successful completion.
- Demonstrates the identification and consideration of risk, and the use of effective risk management and change control systems that will be put into full effect very early in the project and used to mitigate impacts.
- Demonstrates a comprehensive plan to address all environmental, health, safety, permitting, and compliance concerns.

The Program draws on Independent Engineers, financial analysts, project officers, and other advisor(s) to review proposed project management plans, including scope, schedule, and budget, and the reasonableness and readiness of the projects. The Program also utilizes a “stage-gate” process, combined with comprehensive annual project reviews and/or go/no-go decisions, to evaluate the status of the projects against the original baseline.

In order to minimize risk within the current portfolio, the Program employs a risk management approach to assess each project. This evaluation serves to identify areas of risk that may require further attention before projects begin and uses a methodology to ensure that projects progress as expected.

Integrated Biorefinery Interfaces with R&D

The Program’s R&D is focused on developing the scientific and engineering underpinnings of a bioenergy industry by understanding technical barriers and providing process and engineering solutions. The IBR public/private partnerships offer a unique opportunity to validate technologies at scale and leverage additional assets to resolve the underlying technical problems.

The product of these partnerships is primarily operational data, which the Program will use to validate the cost and performance of the respective technology. The partnerships must report on technical progress including process flow diagrams, mass and energy balances, and process performance parameters by unit operation. They also provide financial data including pro forma and actual capital and operating costs. Sustainability metrics associated with the facility or system will also be collected.

The data from the IBR partnerships is evaluated and used as input to Program portfolios and strategic planning.

Feedstock R&D

A biorefinery must operate with predictable efficiency; therefore, plant operations are dependent on a continuous, consistent feedstock supply to achieve their commercial targets. Feedstock cost, availability, variability, quality control, and storage are all parameters that affect the economics of the plant.

Biochemical Conversion R&D

The development of advanced biochemical conversion technology performance and cost targets must be accomplished to achieve broad deployment and full commercialization of the integrated biorefinery model. Through the implementation of the necessary technological advances, cellulosic feedstock conversion processes have the potential to achieve similar investment returns as conventional grain-based processes. The integration of cellulosic conversion technologies in conventional biofuels production operations will likely have a synergistic effect and lower the entry cost of cellulosic biofuels and improve the bottom line of the conventional commercial operations.

Thermochemical Conversion R&D

The development of advanced thermochemical conversion technology performance and cost targets must be accomplished to achieve broad deployment and full commercialization of the integrated biorefinery model. Advances in various thermochemical biorefinery technologies must be made to increase feedstock flexibility, diversify biofuel product options, and maximize plant performance economics.

Although thermochemical and biochemical conversions are treated as separate topics, a number of technology applications will employ components from both conversion technology areas to optimize yield, productivity, and efficiency.

2.3.1 Integrated Biorefineries Support of Program Strategic Goals

IBR projects are the mechanism used by the Program to validate its technology goal: to develop and deploy sustainable, cost-competitive biomass conversion technologies to produce biofuels that support meeting EISA RFS targets.

IBR's strategic goal is to *demonstrate and validate integrated technologies to achieve commercially acceptable performance and cost pro forma targets*. This goal is best accomplished through public-private partnerships.

The IBR technology area directly addresses and supports all feedstock and conversion pathways as shown in Figure 2-22.

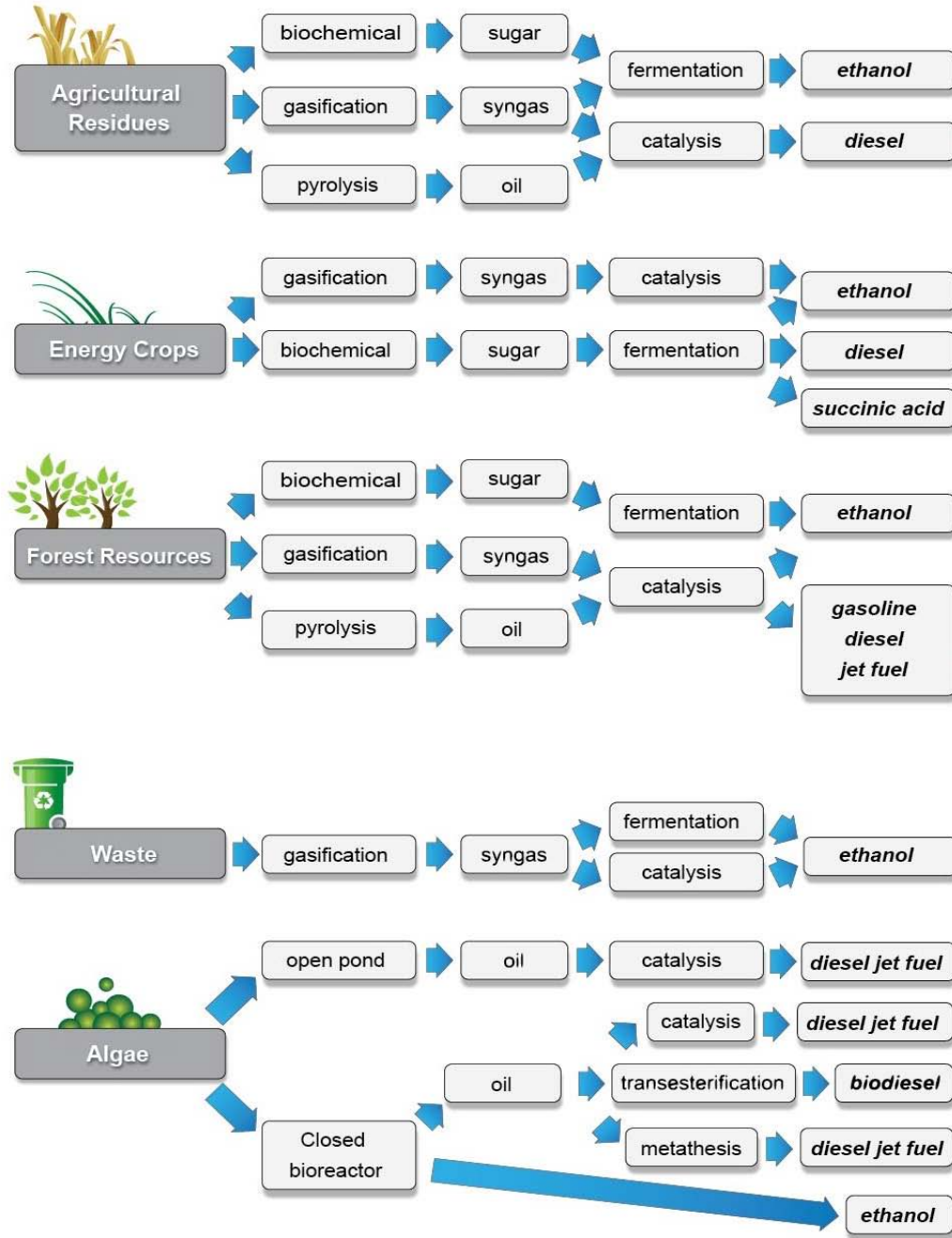

Figure 2-22: Current Integrated Biorefineries Project Pathways

2.3.2 Integrated Biorefineries Support of Program Performance Goals

The 2012 performance goal of the IBR technology area is to demonstrate the successful operation of three integrated biorefineries across various pathways. By 2017, mature* technology plant model† will be validated for cost of ethanol production based on demonstration plant performance and compared to the target of \$1.76/gal EtOH (\$2.62/GGE). The 2014 performance goal is to validate a total annual production capacity of 100 million gallons of advanced biofuels.

The final intent is for the six commercial-scale facilities to be techno-economically viable, ongoing production facilities that contribute to meeting the RFS targets. The pilot- and demonstration-scale projects may not be economically viable for ongoing biofuel production at their respective scales. Rather, at the pilot and demonstration scale, these integrated biorefinery projects will generate at least 1,000 hours of continuous operational data that support the design of a techno-economically viable commercial-scale facility. Pilot- and demonstration-scale facilities can also help identify additional barriers that need to be addressed through further R&D to enable viable commercial production stage.

The percentage contribution of each project toward the 2014 advanced biofuels volumetric performance goal for the feedstock pathways currently under investigation is shown in Table 2-6.

Table 2-6: Estimated Project Contribution for 2014 Biofuel Production Capacity Goal

Project	Percent of 2014 Production Capacity	Conversion Route	Feedstock
Abengoa	15%	Biochemical	Agricultural Residue
Poet	24%	Biochemical	Agricultural Residue
Pacific	2.5%	Biochemical	Energy Crops
Lignol	2.5%	Biochemical	Forest Resources
Mascoma	19%	Biochemical	Forest Resources
Verenium	1.5%	Biochemical	Agricultural Residue
Range Fuels	19%	Thermochemical	Forest Resources
RSA	1.5%	Biochemical	Forest Resources
Flambeau	9%	Thermochemical	Forest Resources
NewPage	6%	Thermochemical	Forest Resources

Table 2-7 shows how the 29 competitively selected integrated biorefinery projects in which the Program is invested are distributed by scale, feedstock type, and fuel type.

* The ethanol production cost targets are estimated mature technology processing costs which means that the capital and operating costs are assumed to be for an “nth plant” where several plants have been built and are operating successfully so that additional costs for risk financing, longer startups, under performance, and other costs associated with first-of-a-kind plants are not included.

† The modeled cost refers to the use of models to project the cost such as those defined in the NREL design reports:

- (1) “Lignocellulosic Biomass to Ethanol Process Design and Economics Utilizing Co-Current Dilute Acid Prehydrolysis and Enzymatic Hydrolysis for Corn Stover,” NREL TP-510-32438, June 2002.
- (2) “Thermochemical Ethanol via Indirect Gasification and Mixed Alcohol Synthesis of Lignocellulosic Biomass,” NREL/TP-510-41168, April 2007.
- (3) “Uniform-Format Solid Feedstock Supply System: A Commodity-Scale Design to Produce an Infrastructure-Compatible Build Solid from Lignocellulosic Biomass,” near final draft at April 24, 2009.

Table 2-7: Competitively Selected Integrated Biorefinery Projects by Feedstock and Fuel Type

Pathway/Feedstock	Total	Agricultural Residues	Energy Crops	Forest Resources	Waste Processing	Algae Processing	Fuel Pathway	Ethanol/ Other Alcohols	FT Liquids/ Renewable Hydrocarbon	Power	Products	Total
Total	29	6	5	12	2	4		17	11		1	29
Integrated Biorefinery Deployment	27	6	5	11	2	3		17	9		1	27
<i>Pilot</i>	12	3	3	4		2		6	6			12
<i>Demonstration</i>	9	1	2	3	2	1		6	2		1	9
<i>Commercial</i>	6	2		4				5	1			6
Continued Technology Development	2			1		1			2			2

2.3.3 Integrated Biorefineries Challenges and Barriers

Market Challenges and Barriers

Im-A. Inadequate Supply Chain Infrastructure: The lack of commoditized feedstocks and feedstock infrastructure increases the uncertainty associated with a sustainable feedstock supply chain. Variable composition, geographical diversity, and diverse physical characteristics increase the radius of collection and therefore, the delivered cost of feedstock. Once demand is established, the infrastructure is expected to grow accordingly. Producing and delivering commoditized feedstock in sufficient volume to support a commercial advanced biofuels industry will require incentive programs to stimulate the large capital investments needed for production, pre-processing, storage, and transport to commodity markets.

Im-B. Agricultural Sector-Wide Paradigm Shift: Energy production from biomass on a scale sufficient to meet EISA RFS goals, or those of a future Renewable Portfolio Standard (RPS), will require a series of major system changes that will take time to implement. Current harvesting, storage, and transportation systems are inadequate for processing and distributing biomass on the scale needed to support dramatically larger volumes of biofuels production.

Im-C. Lack of Understanding of Environmental/Energy Tradeoffs: A systematic evaluation of expanded biofuels production impact on the environment and food supply for humans and animals is insufficient. Sufficient data needs to be generated from various operational facility designs to provide valid sustainability benchmarks for the nascent industry. Analytical tools are needed to facilitate consistent evaluation of energy benefits and greenhouse gas emissions (GHG) impacts of all potential advanced biofuel feedstock and production processes. EISA 2007 requires that all biofuels be evaluated for their reduction in greenhouse gas emissions in order to qualify under the RFS. Cellulosic biofuels, a subset of “advanced biofuels,” must achieve at least 60% reduction in GHG emissions relative to a 2005 baseline of the petroleum

displaced, including indirect land use change. Advanced biofuels must achieve at least 50% reduction in GHG emissions. EPA has established the methodology for evaluating these impacts for some pathways.

Im-D. High Risk of Large Capital Investments: Once emerging biomass technologies have been developed and tested, they must be commercially deployed. Financial barriers are the most challenging aspect of technology deployment. Capital costs for commercially viable facilities are relatively high, and securing capital for an unproven technology is extremely difficult. Lenders are hesitant to provide debt financing for first-of-a-kind commercial facilities, where the process performance cannot be adequately guaranteed. For private investors to have the confidence to invest equity in biomass technology applications, the technology must be fully demonstrated and validated at commercial scale. Government assistance to validate proof of performance at the pilot, demonstration, and first-of-a-kind commercial scales is critical to successful deployment.

Im-E. Lack of Industry Standards and Regulations: The lack of local, state, and federal regulations and inconsistency among existing regulations constrain development of the biomass industry. The long lead times associated with developing and understanding new and revised regulations for technology can delay or stifle commercialization and deployment. Consistent standards and sampling methods are lacking for feedstock supply and infrastructure, as well as for biofuel products and the associated distribution infrastructure.

Im-F. Cost of Production: An overarching market barrier for biomass technologies is the inability to compete, in most applications, with fossil energy supplies and their established supporting facilities and infrastructure. Uncertainties in fossil energy price and supply continue to exert upward pressure on the price of petroleum-derived fuels and products. Nevertheless, reductions in production costs along the entire biomass supply chain, including feedstock supply, conversion processes, and product distribution, are needed to make advanced biofuels and bioproducts competitive with petroleum-derived analogs.

Im-G. Off-take Agreements: Production costs and hence selling price and profits of commodity fuels and chemicals based on crude oil are dependent on a fluctuating market. The fact that petroleum companies and ethanol producers still return a profit in the face of these fluctuating markets indicates that off-take agreements or contracts have been formulated to address such issues. Generally these companies offer products on contract basis, but also sell on the spot market to generate the greatest return on investment. Off-take agreements can often take the form of fixed price contracts for 1-2 years followed by contracts fixed to a specific index such as the Chicago Board of Trade pricing. The producer then must adjust their *pro forma* accounting and variable cost structure to account for such market fluctuations.

Technical Challenges/Barriers

It-A. End-to-End Process Integration: Successful deployment of the biorefinery business model is dependent on advances in biochemical and thermochemical biomass conversion process technologies. The biorefinery concept encompasses a wide range of technical issues related to collecting, storing, transporting, and processing diverse feedstocks, as well as the complexity of integrating new and unproven process steps. The demonstration and validation of total process

integration from feedstock production to end product distribution is crucial as it impacts both performance and profitability.

It-B. Demonstration-Scale Facilities: As with all new process technologies, demonstrating sustained integrated performance that meets technical, environmental, and safety requirements at sufficiently large scale is an essential step toward commercialization. Demonstration-scale facilities that are capable of validating new integrated process technologies and generating the process performance parameters and equipment specifications for commercial-scale plant design are critical to successful commercial deployment. Additionally, increased understanding of the performance of integrated systems at demonstration scale will result in the optimization of process design configurations for commercial-scale facilities.

It-C. Risk of First-of-a-kind Technology: The first biorefineries will incorporate a variety of new technologies. The number and complexity of new process steps implemented in pilot- and demonstration-scale projects has been shown to be a strong predictor of future commercial performance shortfalls. Heat and mass balances, and their implications, are not likely to be well understood with regard to new technologies. In addition, the unanticipated buildup of impurities in process recycle streams can result in degradation of chemical performance, abrasion and corrosion of plant equipment, and deactivation of process catalysts.

It-E. Engineering Modeling Tools: The current level of understanding regarding fuels chemistry is insufficient for optimization, scale-up, and commercialization. In order to better understand how fuel chemistry affects commercial viability, rigorous computational fluid dynamic models are needed. Engineering modeling tools are also needed to address heat integration issues.

2.3.4 Integrated Biorefineries Approach for Overcoming Challenges and Barriers

The Program's efforts to overcome the challenges and barriers associated with the IBR technology area are organized around five pathways (see Appendix C for a description of the Program's strategy framework of biorefinery pathways) as illustrated in Figure 2-23. Each pathway includes the following activities:

- Deployment: Includes all the major integrated biorefinery projects
- Technical assistance: Covers smaller R&D projects that are identified by the IBR team with industry partners and stakeholders as critical to improving existing biorefinery operations
- Technical analysis: Includes a broad range of technical, economic, and environmental topics and is used to assess the individual progress of the IBR projects, as well as the collective status and progress of the bioindustry

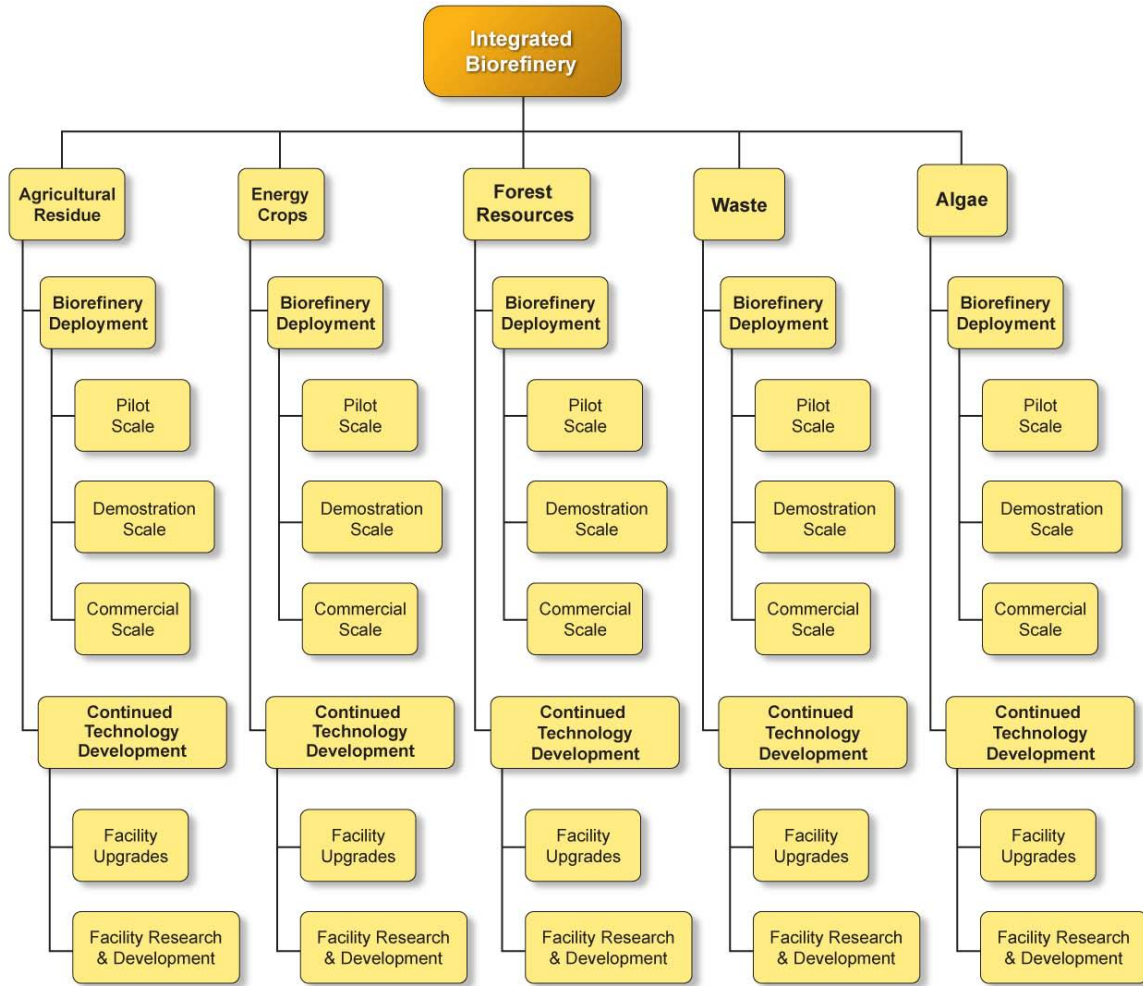

Figure 2-23: Integrated Biorefineries Work Breakdown Structure

Agricultural Residue Processing Pathway

The objective is to develop and demonstrate commercially viable processes and systems to convert residues from current agricultural production activities to biofuels and bioproducts. Both biochemical and thermochemical conversion technologies, individually or in combination, are being used to produce ethanol, green diesel, and chemical intermediates. Using existing agricultural residues is seen as the primary strategy to bridge the gap between near-term niche, low-cost biomass supplies, and long-term high-volume dedicated energy crops.

Energy Crops Processing Pathway

The objective for this pathway is to develop and demonstrate commercially viable processes and systems to convert dedicated energy crops to biofuels, which is the foundation of the long-term strategy for petroleum displacement. Conversion technologies and processes for dedicated perennial feedstocks will build on the experience gained through processing agricultural and forest residues and process intermediates in commercial-scale facilities. Both biochemical and thermochemical conversion technologies are under evaluation.

Forest Resources Processing Pathway

The objectives of this pathway include the development and demonstration of the conversion of forest resources to biofuels, biopower, and bioproducts. When co-located with a pulp and paper facility, the addition of biofuel capabilities may also improve the economic efficiency of those existing operations. This pathway could include the conversion of underperforming pulp and paper mills into plants that produce biofuel, biopower, and bioproducts with no impact to paper quality.

Waste Processing Pathway

This pathway was added to the Program portfolio based on the quantity and availability of cellulosic wastes for biofuels production. The objective is to develop and demonstrate commercially viable processes to convert the cellulosic fractions of various waste streams to biofuels. Feedstocks include sorted municipal solid waste, urban wood waste, and construction and demolition wastes.

Algal Processing Pathway

This pathway demonstrates the potential to mass-produce algae with high oil content and to reduce the cost of algae production to an acceptable level. The goal is low-cost algae oil production, which requires higher productivities and oil content than currently achievable. There is a need to isolate, screen, select, and test various algal strains in open ponds and enclosed bioreactors, and to genetically enhance algal strains for higher oil content and overall productivity (i.e., both photosynthetic and heterotrophic productivity), as well as resistance to grazers, invasions, temperature, and other environmental factors.

The approaches for overcoming the barriers within each pathway, along with specific tasks/activities, are described in Table 2-8. Integration is the key component for successful development and deployment of a biorefinery. The Program's biorefinery industrial partnerships are each associated with a principal pathway, and most incorporate crosscutting elements involving secondary, and in some cases tertiary, feedstocks and thus could support multiple pathways.

Table 2-8: Integrated Biorefinery Activity Summary

Goal: Demonstrate and validate integrated technologies to achieve commercially acceptable performance and cost pro-forma targets			
WBS Element	Performer	Feedstock Pathway	Barriers Addressed
Integrated Biorefinery Deployment and Portfolio Management			
Pilot Scale – Integrated unit operations to produce fuels, power or products at the scale of at least 1 metric tonne.	ADM; Logos Technologies; Renewable Energy Institute International	Agricultural Residue Processing	Im-A: Inadequate Supply Chain Infrastructure; Im-B: Agricultural Sector-Wide Paradigm Shift; Im-C: Lack of Understanding of Environmental/ Energy Tradeoffs; Im-D: High Risk of Large Capital Investments; It-A: End-to-End Process Integration; It-B: Commercial-Scale Demonstration Facilities; It-C: Risk of First-of-a-kind Technology; It-E: Engineering Modeling Tools St-C: Sustainability Data across Supply Chain
	ICM, Inc.; Amyris Biotechnologies, Inc.; ZeaChem, Inc.	Energy Crops Processing	
	American Process, Inc; Haldor Topsoe, Inc.; UOP, LLC; ClearFuels Technology, Inc.;	Forest Resources Processing	
	Algenol Biofuels; Solazyme, Inc.	Algae Processing	
Demonstration Scale – Integrated projects that convert at least 50 or 70 metric tonnes of biomass to biofuels, biopower, and/or bioproducts.	Verenium Biofuels Corp.	Agricultural Residue Processing	
	Myriant Technologies, Inc.; Pacific Ethanol, Inc.	Energy Crops Processing	
	Lignol Innovations; Red Shield Acquisition (RSA); NewPage Corporation;	Forest Resources Processing	
	Enerkem Corporation; INEOS	Waste Processing	
	Sapphire Energy, Inc.	Algae Processing	
Commercial Scale – Integrated commercial-scale projects that convert at least 700 metric tonnes of biomass to biofuels, biopower, and/or bioproducts, without government subsidies.	Abengoa Bioenergy LLC; POET	Agricultural Residue Processing	
	BlueFire Ethanol, Inc.; Range Fuels, Inc.; Mascoma; Flambeau River Biofuels LLC	Forest Resources Processing	
Continued Technology Development			
Identify opportunities for process optimization with the goal of reducing cost and increasing efficiency. Validate these improvements at existing pilot, demonstration or commercial scale facilities.	Gas Technology Institute	Forest Resources Processing	
	Elevance Renewable Sciences	Algae Processing	

2.3.5 *Prioritizing Integrated Biorefinery Barriers*

The Biomass Program is developing a suite of technologies across the biorefinery pathways to enable a broad spectrum of biomass resources to be used in the production of a variety of biofuels.

2.3.6 *Integrated Biorefinery Milestones and Decision Points*

The key IBR milestones, inputs/outputs and decision points to complete the tasks described in [Section 2.3.4](#) are summarized in the chart in Figure 2-24.

Given the cost and technology maturity for the demonstration- and commercial-scale efforts, this work is conducted via competitively awarded cost-share agreements with industry. The targets/milestones listed in Figure 2-24 include the successful operation of integrated systems and validate performance metrics for each project. Milestones and go/no-go decisions track the progression from contract award to construction, start-up and operation of each pilot, demonstration- or commercial-scale biorefinery.

The following definitions apply to the programmatic milestones listed in Figure 2-24.

- **Demonstrate:** At pilot scale and beyond, verify that the unit operations operate as designed and meet the complete set of performance metrics (individually and as an integrated system).
- **Validate:** At pilot scale and beyond, ensure the process/system meets desired expectations/original intent. Validation goes beyond just meeting all of the performance metrics; it is an assessment of whether the system actually fulfills/completes a portion of the program effort so that the Program can move on to the next priority.

Figure 2-24: Integrated Biorefineries Gantt Chart

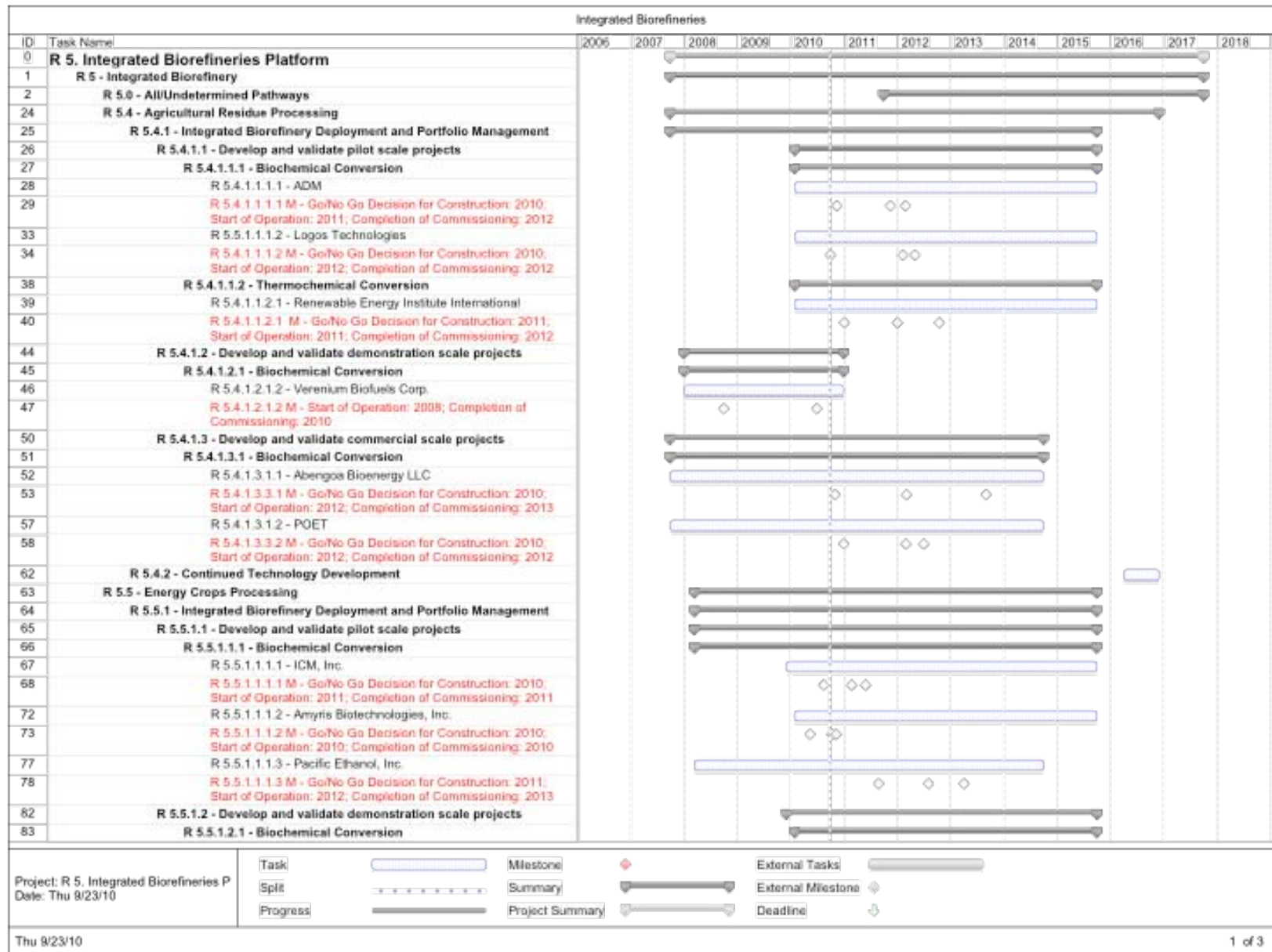

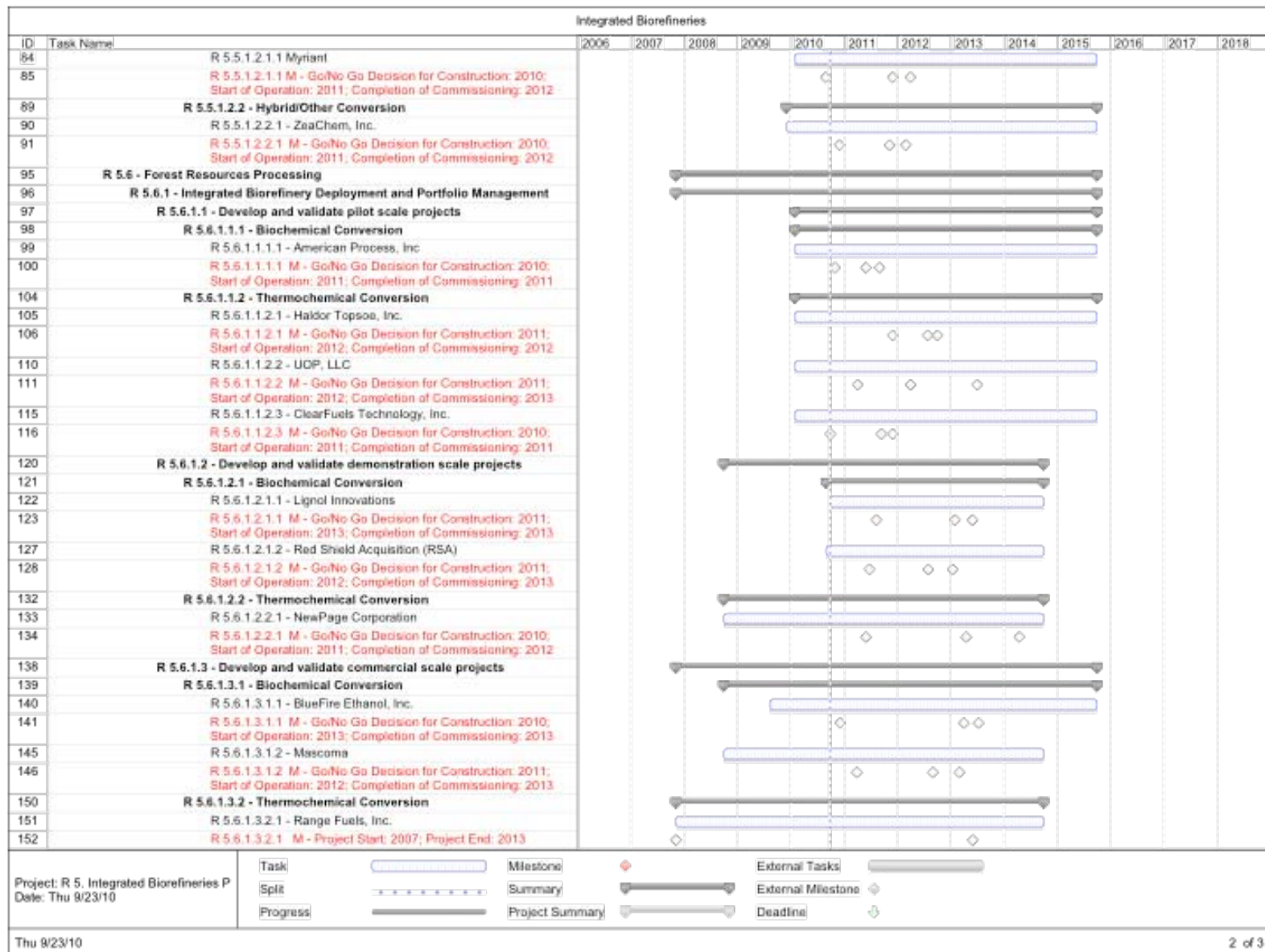

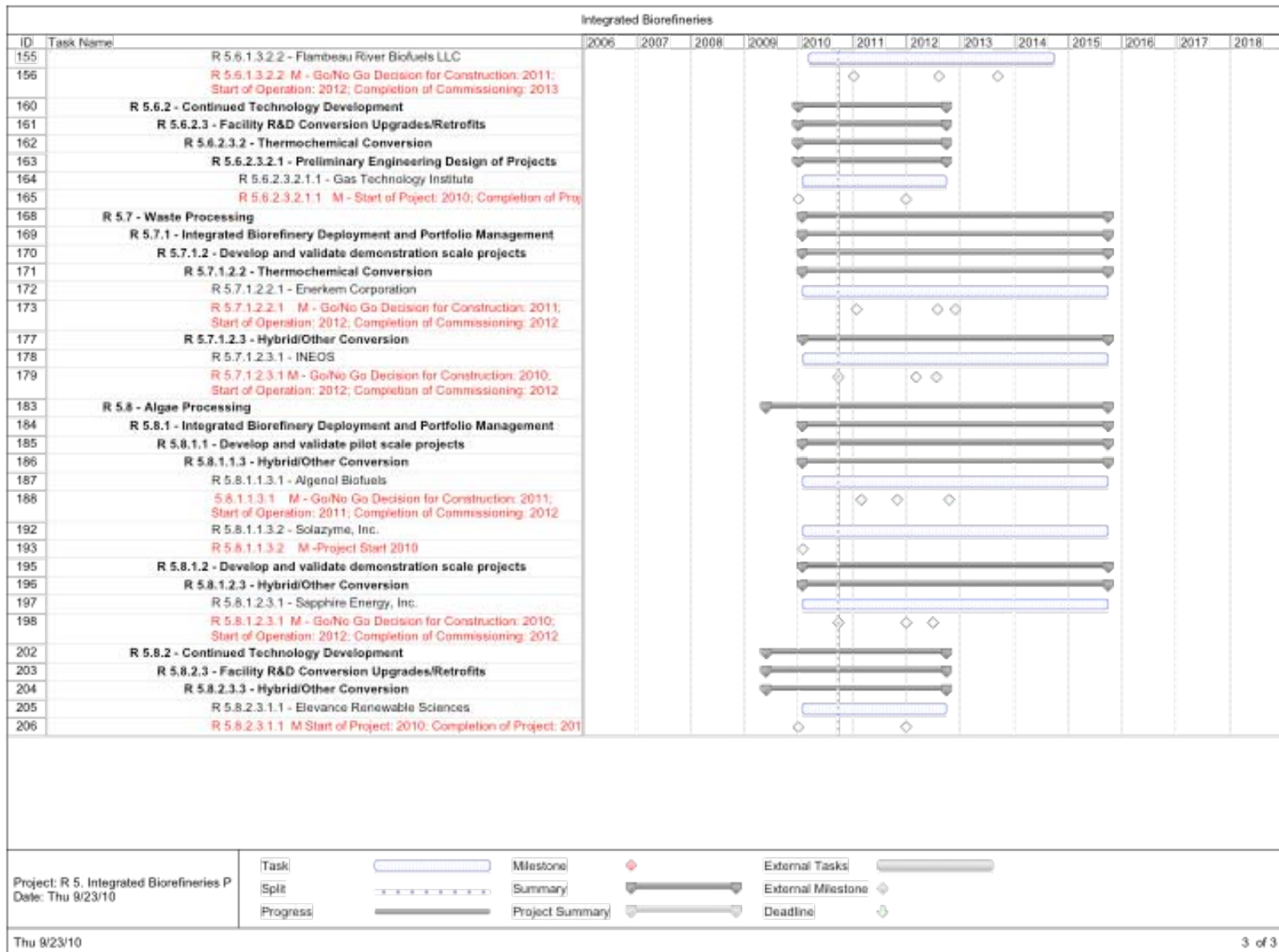

2.4 Biofuels Distribution Infrastructure and End Use

The Biofuels Distribution Infrastructure and End Use (Infrastructure) technology area focuses on developing a safe and cost-effective biofuels delivery infrastructure (Figure 2-25) in order to meet the Biomass Program's strategic goal and the EISA RFS target of 36 billion gallons of biofuels by 2022.

Today, the market for biofuels in the U.S. consists primarily of corn-starch-based ethanol which uses its own delivery infrastructure due to incompatibilities with the existing petroleum infrastructure. The market also includes small amounts of soybean derived biodiesel. Of the nearly 10 billion gallons of ethanol produced in 2009, more than 99% was marketed as an E10 blend for use in conventional vehicles with the remainder being marketed as E85 for use in flex fuel vehicles (FFVs). Currently, over 80% of gasoline in the United States contains E10, which means that this market for ethanol will soon be reaching saturation, often referred to as the E10 blend wall. Beyond the E10 blend wall, the market for ethanol could be expanded either through the introduction and use of intermediate ethanol blends (e.g., E15 or E20) for use in conventional vehicles or through the expansion of E85. DOE's Biomass and Vehicle Technologies Programs are examining the effects of intermediate blends on vehicle performance, materials compatibility, exhaust emissions, and other criteria. In order for ethanol blends higher than E10 to be fully available for use in conventional vehicles, a variety of infrastructure issues including distribution and dispensing, storage, codes and standards, and liability and warranty issues must be addressed to enable widespread use of E15.

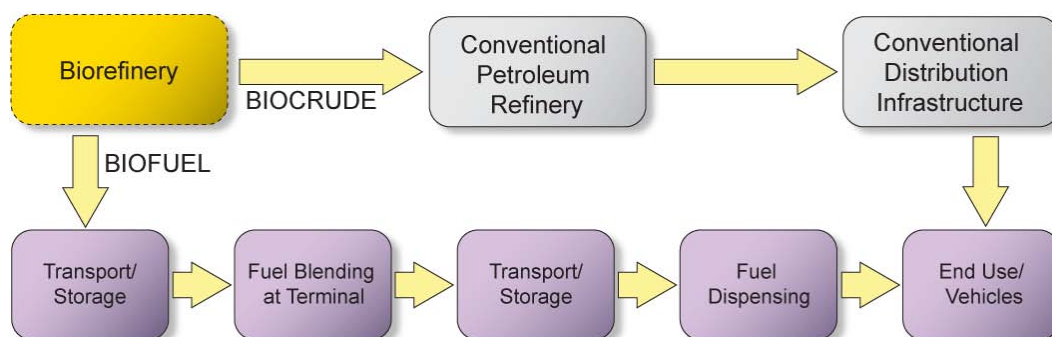

Figure 2-25: Distribution Infrastructure and End Use Flow Chart

A number of other biofuel technologies currently under development may alleviate some of the infrastructure challenges involved in distributing and using ethanol. Renewable hydrocarbon fuels (i.e., renewable gasoline, diesel, and jet fuel) are being developed and are expected to have chemical compositions virtually identical to their petroleum counterparts, and thus have the potential to be fully compatible and fungible with the existing petroleum infrastructure. Other advanced biofuels, such as biobutanol may also be more compatible with existing infrastructure than ethanol and could have characteristics closer to conventional petroleum products. Infrastructure R&D will work to balance the short- and medium-term needs for ethanol infrastructure with the potential for new biofuels and their infrastructure needs.

Transportation and Storage: Petroleum fuels are transported predominantly through a network of pipelines from coastal production and import centers to terminals that are dispersed across the

country. Pipelines are the most efficient and lowest cost transport method for large volumes and long distances. Trucks are used to transport refined petroleum products from the terminals to refueling stations, typically 50 miles or less.

Corn ethanol is produced predominantly in the Midwest and distributed to major demand centers on the East and West Coasts. Due to material compatibility and pipeline operational concerns, denatured ethanol (95% ethanol/5% gasoline) is generally transported by rail from biorefineries to existing petroleum terminals where it is blended with gasoline, and then transported by truck to refueling stations. Since transport by road and rail is more costly than by pipeline, DOE and the Department of Transportation (DOT) are researching operational and compatibility issues to reduce technical barriers to low cost transport of ethanol via pipeline.

Advanced cellulosic biofuels are expected to utilize a wider variety of biomass resources to produce a broader array of biofuels, and cellulosic biorefineries are expected to be more widely distributed throughout the country. This could alleviate some of the extra cost and logistical constraints involved in transporting biofuels out of the Midwest. Renewable hydrocarbon biofuels are expected to be more compatible with existing infrastructure and fungible with petroleum fuels, but further research, testing, and characterization is required to validate these expectations.

Other advanced biofuel technologies involve the production of biocrudes, an intermediate product that can serve as a precursor to renewable gasoline, diesel, and jet fuel (e.g., pyrolysis oil or algae oil). These biocrudes will need to be transported from their production location near the biomass source to a biorefinery or conventional refinery for processing into a final fuel product. The Program will help support the resolution of any issues related to the availability and cost of biocrude transport.

Fuel Dispensing and Vehicle End Use: All conventional highway vehicles manufactured since 1978 are certified to run on blends of ethanol up to E10. In contrast, only certified flex-fuel vehicles (FFVs) are designed to run on higher level ethanol blends, up to E85. At refueling stations, E10 is stored and dispensed in the same tanks and dispensers as gasoline. E85 requires a special dispenser and separate storage tank which together can cost over \$60,000 to install at a refueling station. Currently, only around 8 million FFVs and fewer than 2,000 E85 retail stations are in use in the United States, located mostly in the Midwest. To encourage FFV production, the CAFE program* allows for credits to be awarded to automakers for FFVs toward meeting the mandated fuel economy standards. As a result, most FFVs manufactured today are large SUVs and pick-up trucks. Additionally, because they are not always explicitly marketed as such, many consumers do not even realize their vehicle is an FFV. Given these issues and other factors, the market for E85 has been slow to develop.

* Corporate Average Fuel Economy or CAFÉ program regulates the fuel economy of cars and light vehicles to mandatory levels. <http://www.nhtsa.gov/fuel-economy>

2.4.1 Biofuels Distribution Infrastructure and End Use R&D Support of Program Strategic Goals

Infrastructure R&D's strategic goal is to *create the conditions whereby all biofuels can safely, cost-effectively, and sustainably reach their market and be used by consumers as a replacement for petroleum fuels.*

The Infrastructure technology area supports the economic and geospatial evaluation of the U.S. biofuels distribution infrastructure needs. It funds research to enable low cost pipeline transport of ethanol and other emerging biofuels; address biofuels' material and other compatibility issues relative to delivery infrastructure and vehicles; and facilitate and expedite testing, characterization, codes and standards development, and approval process for use of all promising biofuels.

2.4.2 Biofuels Distribution Infrastructure and End Use R&D Support of Program Performance Goals

The Biomass Program's performance goal is to *help create an environment conducive to maximizing the production and use of biofuels by 2022.* In support of this program goal, the Infrastructure technology area has a volumetric and cost performance goal.

Volumetric Goal: *Facilitate development of the infrastructure and market capacity to transport, store, and use 24 billion gallons of biofuels by 2017 and 36 billion gallons by 2022.*

Cost Goal: *Reduce the biofuels delivery cost to be competitive with the delivery costs of gasoline and diesel fuels – less than \$0.16 per gallon by 2017.*

Major milestones towards reaching these goals include:

By 2011, existing infrastructure modes and transportation capacity for ethanol assessed and E15 testing and characterization completed

By 2012, market end use capacity for ethanol based on E15 waiver decision determined

By 2017, all appropriate testing and characterization of the most promising advanced biofuels completed

2.4.3 Biofuels Distribution Infrastructure Challenges and Barriers

Market Challenges and Barriers

Availability of Biofuels Distribution Infrastructure: The infrastructure required to distribute and dispense large volumes of ethanol does not currently exist, which puts this biofuel at a disadvantage compared to conventional liquid transportation fuels that already have mature infrastructure. Ethanol is currently transported predominantly by rail and truck. Without large capital investments, these transport modes are expected to encounter significant congestion issues over the coming decades, especially in the Midwest. Higher level ethanol blends, such as E85 (and other less compatible biofuels), require separate storage tanks and dispensers, and may require other material modifications at refueling stations. Most refueling stations are privately owned with relatively thin profit margins, and owners have been reluctant to invest in new

infrastructure until the market is more fully developed. Further, some refueling stations may not have enough space available to add dispensers and new storage tanks. The scarcity of E85 refueling stations makes it difficult for consumers who own FFVs to use E85 and also makes it less likely that potential new consumers will purchase an FFV. Petroleum-compatible biofuels may also require distribution infrastructure investment including east-west pipeline expansion.

Availability of Biofuel-Compatible Vehicles: Out of roughly 254 million passenger vehicles registered in the United States, only 8 million are E85-compatible FFVs, with many FFV owners not even aware that their vehicles are E85-compatible. Vehicle manufacturers are reluctant to invest in the production of additional FFVs until the dispensing infrastructure is in place.

Market Uncertainty: There is uncertainty regarding the pace of development and commercialization of new biofuels technology. This uncertainty surrounding which biofuels will succeed in the short and long term adds risk to investment in biofuels infrastructure. Other factors, such as the price of oil, the pace of economic recovery, climate legislation and other policy measures also complicates investment decisions.

Higher Biofuel Delivery Costs: Ethanol's incompatibility with the existing petroleum fuel infrastructure, combined with the lower energy density of ethanol compared to petroleum fuels, results in higher delivery costs on per unit energy basis than for petroleum-based fuels. Compatible renewable hydrocarbon biofuels are expected to utilize existing petroleum delivery infrastructure.

Technical Challenges and Barriers

Dt-A. Biofuels Pipeline Compatibility: Pipelines are generally the most efficient and cost-effective way to transport liquid fuels over long distances, but technical and logistical issues have prevented biofuels from being transported in the existing pipeline network. Ethanol blends have not been transported through the existing pipeline network in the United States due to materials compatibility concerns and operational issues. Biodiesel has not been pipelined due to concerns surrounding contamination of jet fuel. Other biofuels will likely need to overcome technical and logistical challenges as well.

Dt-B. Codes, Standards and Approval for Use: New biofuels and biofuel blends must comply with federal, state, and regional regulations before introduction to the market. The U.S. Environmental Protection Agency (EPA) plays a central role in approving new fuels for use; technical codes and standards are developed by organizations including ASTM International, American Petroleum Institute (API), and Underwriters Laboratory (UL); and safety, health, and environmental standards are developed by the Occupational Safety and Health Administration, U.S. Department of Homeland Security, and others. Codes and standards are adopted by state and local jurisdictions to ensure product safety and reliability, and reduce liability. Limited data and technical information can delay approval for use and development of technical codes and standards for biofuels and related infrastructure components including pipelines, storage tanks, and dispensers. The approval process can take years and cost millions of dollars for fuels that are not substantially similar in composition to existing fuels.

Dt-C. Materials Compatibility: Ethanol and other biofuels and intermediates are not fully compatible with the existing petroleum delivery infrastructure. Ethanol can be corrosive toward soft metals and certain types of plastics, which can present a problem for some plastic hoses, gaskets, seals, and nozzles. Because ethanol is both a stronger solvent than petroleum and hygroscopic, it can dissolve hydrocarbon residue in pipelines and storage tanks and/or absorb water resulting in fuel contamination and off-spec material. There is also some concern that ethanol may lead to stress corrosion cracking, which would require technical mitigation. Raw pyrolysis-oil and biocrudes can also be highly corrosive toward distribution infrastructure components. While renewable hydrocarbon biofuels are expected to be fully compatible with the existing petroleum infrastructure, this will need to be verified.

Dt-D. Evaporative Emissions: Ethanol increases the Reid Vapor Pressure (RVP) for blends with gasoline that contain less than about 20% ethanol. This results in higher evaporative hydrocarbon emissions and can change engine performance. This problem can be resolved with proper gasoline blending components but remains a concern as California testing standards do not allow for this adjustment and splash blending does not provide an opportunity to adjust blending components.

Dt-E. Fuel Economy Penalties: Some biofuels result in decreased fuel economy on a miles per gallon basis relative to petroleum fuels. Ethanol has a lower energy density than gasoline, approximately 76,000 Btu/gallon of ethanol in comparison to 115,000 Btu/gallon of gasoline.¹¹ This means that E10 contains around 97% and E85 around 71% of the energy contained in gasoline. Fuel economy is dominated by energy content. However, the higher octane rating of ethanol, 115 compared to 85 – 88 for regular gasoline, may make up for some of ethanol's lower energy content. Actual differences in fuel economy are dependent on a variety of factors and will vary by biofuel type.

Dt-F. Limited Understanding of Downstream Infrastructure Needs: There is insufficient information about the type and magnitude of infrastructure investment needed for a growing biofuels industry. Analyses could provide important insights to government and industry that would enable them to be more effective in their efforts to meet the EISA 2007 RFS. These include projections for the potential production costs of the biofuels being developed compared to projected costs for gasoline and diesel fuels; detailed analysis of biomass resources; biofuels and biocrude potential demand scenarios; and liquid transportation fuel infrastructure needs to meet projected demand scenarios.

Dt-G. Vehicle and Engine Compatibility: Nearly all vehicles manufactured in the United States are certified to run on blends of up to 10% ethanol. Higher ethanol blends have potential compatibility concerns related to vehicle and specialty (e.g., motorcycle, lawnmower, and marine) engine performance, effects on fuel tank, hosing, and other vehicle components, and the impact of exhaust emissions on air quality standards. Research to evaluate the use of intermediate ethanol blends (E15 and E20) in light duty vehicles and specialty engines is currently underway. Renewable hydrocarbon biofuels are not expected to have these compatibility issues, but will require testing and characterization for verification.

2.4.4 Biofuels Infrastructure Approach for Overcoming Challenges and Barriers

The approach for overcoming Infrastructure challenges and barriers is shown in the work breakdown structure in Figure 2-26. There are four primary areas of effort. The first includes analysis; testing, codes and standards; and deployment activities that are pertinent to all biofuels. The other three are focused on specific activities for alcohol fuels; renewable hydrocarbon biofuels and biocrudes; and biodiesel and other FAME-based fuels. *

Achieving the goals of the Infrastructure technology area will require leveraging the resources of federal agencies, the national laboratories, state and local governments, as well as partners in industry, academia, and other affiliated organizations. Several interagency collaborations will be used to coordinate widespread development of biofuels infrastructure. DOE and EPA will collaborate on fuels testing, while DOE will partner with DOT, which has a key role in resolving biofuels transport and logistical issues, including assessing material issues with storage containers and pipelines. DOE will work with ASTM, API, the National Institute of Standards and Technology (NIST), and the UL to facilitate the establishment of specifications, codes, and standards.

Lastly, the Biomass Program will work closely with DOE's Vehicle Technologies Program to build on the latter program's efforts in developing and deploying alternative vehicle and fuel technologies through its Clean Cities Program and other avenues.

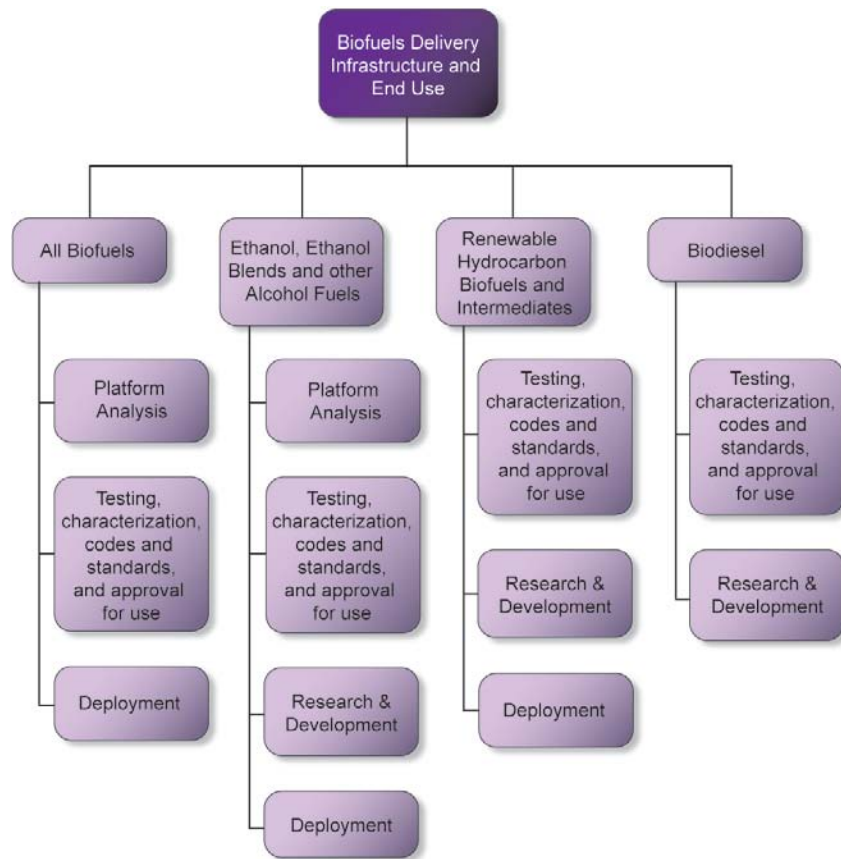

Figure 2-26: Work Breakdown Structure for Biofuels Infrastructure

* FAME-based fuels: Fuels sourced from fatty acid methyl esters such as rapeseed methyl ester and soybean methyl ester

All Biofuels

There is uncertainty around which biofuels will be most important in the short and long term, which introduces risk to capital investment for biofuels infrastructure. In conjunction with Strategic Analysis, evaluations of potential biofuel costs, production locations, and infrastructure needs and costs through 2030, using bounding scenarios, will be conducted to help reduce this uncertainty.

The testing, codes, and standards effort will identify all the testing and characterization that is required in order to get a new biofuel approved for use and commercialized. This will be done jointly with pertinent stakeholders, including EPA, DOT, ASTM, API, UL, pipeline operators, and automotive companies. The end result is targeted to include a standing task force of stakeholders committed to facilitate and expedite the required testing, approvals, and codes and standards for promising new biofuels.

The deployment effort will support market development and consumer acceptance through education and training on the safety, health, and environmental issues related to the transport and use of biofuels.

Ethanol and Other Alcohols

In order to reduce the cost of delivering ethanol and other alcohol fuels so as to be competitive with the cost of delivering petroleum fuels, barriers to pipeline delivery must be addressed. Both analysis and R&D will be done to determine how to overcome the issues with ethanol so that it can utilize the existing petroleum pipeline infrastructure and/or to develop lower cost pipeline technology that can be profitable at projected ethanol volumes.

In order to expand the ethanol market beyond the E10 blend wall, higher blends of ethanol need to be utilized either through use of intermediate blends (e.g., E15 and E20) in conventional vehicles or through the significant expansion of E85. Activities to address this include facilitating and expediting the testing of these intermediate blends for their potential use in conventional vehicles and facilitating the expansion of infrastructure needed for dispensing E85 (and E15 or E20 if needed.)

Renewable Hydrocarbon Biofuels and Their Biocrudes

Renewable hydrocarbon biofuel compatibility with the petroleum infrastructure and conventional vehicles, and full fungibility with petroleum fuels needs to be verified through testing and characterization. Any issues with infrastructure or vehicle compatibility will be addressed through R&D. There are also activities to facilitate and expedite development of specifications, codes and standards, and approval process for use of these biofuels.

Biodiesel and other FAME Biofuels

Biodiesel is produced from plant oils as well as waste fats and greases and, in the future, potentially from algal oils. Among other reasons, biodiesel is not being delivered through the petroleum infrastructure because it contains oxygen and could contaminate jet fuel which currently has a specification of zero oxygen. The Program will help facilitate Federal Aviation Administration (FAA) testing of jet fuel for 5 ppm and 100 ppm permissible oxygen levels.

Table 2-9: Biofuels Infrastructure Activity Summary

Goal: Create the conditions whereby all biofuels can safely, cost-effectively, and sustainably reach their market and be used by consumers as a replacement for petroleum fuels.			
WBS Element	Description	FY 2010 Performer	Barriers Addressed
All Biofuels			
Analysis	Define the needs for biofuels infrastructure and market use through 2030.	ORNL	Dm-A: Biofuels Distribution Infrastructure; Dm-B: Biofuel-Compatible Vehicles; Dm-C: Market Uncertainty; Dm-D: Biofuel Delivery Costs; Dt-F: Fuels and Infrastructure Analyses
Testing, characterization, codes and standards, and approval for use	Develop framework to facilitate timely testing, codes and standards and approvals for biofuel commercialization.		Dt-B: Codes and Standards
Deployment	Provide education and training on the safety, health and environmental issues related to the transport and use of biofuels.	ORNL, NREL	Dm-B: Biofuels Compatible Vehicles
Ethanol, Ethanol Blends, and other Promising Alcohol Fuels			
Analysis	Assess feasibility of using current petroleum pipeline infrastructure and/or new dedicated pipelines.		Dm-A: Biofuels Distribution Infrastructure; Dm-D: Biofuel Delivery Costs; Dt-C: Materials Compatibility
Testing, characterization, codes and standards, and approval for use	Facilitate testing and characterization and promote development of codes and standards for E15 and E20 by 2012 and for all promising alcohol biofuels by 2017.	NREL, ORNL	Dt-B: Codes and Standards; Dt-D: Evaporative Emissions
Research and Development	Research and develop lower cost pipeline technology and technology solutions to infrastructure and vehicle compatibility issues.	Delphi, Bosch, GM	Dm-A: Biofuels Distribution Infrastructure; Dm-B: Biofuel-Compatible Vehicles; Dm-D: Biofuel Delivery Costs; Dt-C: Materials Compatibility; Dt-D: Evaporative Emissions; Dt-G: Vehicle Compatibility;
Deployment	Work with state and local governments, the DOE Clean Cities Program, automobile manufacturers, and other stakeholders to promote the expansion of E85 stations, E15/E20 dispensing if needed, and FFV availability.	Protec, Missouri Corn Merchandising Council, Clean Energy Coalition, Growth Energy	Dm-A: Biofuels Distribution Infrastructure
Renewable Hydrocarbon Biofuels and Intermediates			
Testing, characterization, codes and standards, and approval for use	Test to confirm hydrocarbon biofuel compatibility with petroleum infrastructure and conventional vehicles. Test and characterize biocrudes and facilitate specifications, codes and standards, and approvals needed for commercialization.		Dm-C: Market Uncertainty; Dm-D: Biofuel Delivery Costs; Dt-B: Codes and Standards
Research and Development	<i>If needed</i> , research and develop low cost technology for delivery and use.		Dm-A: Biofuels Distribution Infrastructure; Dm-B: Biofuel-Compatible Vehicles; Dm-D: Biofuel Delivery Costs; Dt-C: Materials Compatibility; Dt-G: Vehicle Compatibility
Deployment	Identify markets and pilot test promising hydrocarbon biofuels.		Dm-C: Market Uncertainty
Biodiesel (and other FAME biofuels)			
Testing, characterization, codes and standards, and approval for use	Facilitate testing of biodiesel transport for existing petroleum infrastructure. Facilitate FAA testing of low oxygen level jet fuel.		Dt-B: Codes and Standards; Dt-C: Materials Compatibility
Research and Development	Develop solutions to potential compatibility issues with the petroleum infrastructure and cold start, storage, and cloud point.		Dm-A: Biofuels Distribution Infrastructure; Dm-B: Biofuel-Compatible Vehicles; Dm-D: Biofuel Delivery Costs; Dt-C: Materials Compatibility; G: Vehicle Compatibility

2.4.5 Prioritizing Infrastructure Barriers and Activities

In order to achieve the Infrastructure goal of having sufficient and cost-effective delivery infrastructure and market capacity in place to meet the EISA RFS mandate, all of the challenges and barriers identified above need to be addressed. However, the following five issues are critical and will be emphasized within the technology area’s efforts:

- Market Uncertainty: Assessing which biofuels will be most important and when
- Ethanol Deployment: Expedited testing for intermediate ethanol blends (E15 and E20) and the need for infrastructure for dispensing E85 (and E15 and E20 if required)
- Advanced Biofuel Compatibility: Testing and characterization of renewable hydrocarbon fuels to confirm their anticipated compatibility with the petroleum infrastructure and current vehicles, and fungibility with their petroleum counterparts
- Biofuel Pipelines: Remedies that enable cost-effective pipeline transport of ethanol and all biofuels
- Codes and Standards: Timely testing, approval decisions, and appropriate specification and codes and standards for all new promising biofuels

Table 2-10: Fuel Transport Costs (2017 estimates)

	Gasoline	Diesel
Distribution Cost (USD/gal) ¹²	0.15	0.19
Consumption (million barrels per day) ¹³	9.06	3.86
Market share	70%	30%
Weighted average distribution cost (USD/gal) [*]	0.16	

Distribution costs for liquid fuels are lowest for pipeline transport and highest for truck transport with rail transport falling somewhere in between. Based on industry sources, the current cost of distributing liquid fuel over 1,000 miles is approximately \$0.03/gal via pipeline, \$0.16/gal via rail, and more than \$0.40/gal via truck. Because ethanol is currently delivered mainly by rail and truck, delivery costs are higher than delivery costs for petroleum fuels which utilize pipeline infrastructure. Table 2-10 shows estimated 2017 distribution costs and consumption volumes for gasoline and diesel. In order for biofuels to be cost-competitive with petroleum-based fuels, they will need to meet an average distribution cost of \$0.16/gal. The Program will focus its R&D on finding solutions to issues preventing ethanol and other biofuels from being transported in the petroleum pipeline infrastructure, as well as fund research to develop lower cost pipeline technology for dedicated biofuel pipelines.

2.4.6 Biofuels Distribution Infrastructure and End Use Milestones and Decision Points

The key milestones, inputs/outputs, and decision points to complete the tasks described in [Section 2.4.4](#) are summarized in the chart in Figure 2-27.

^{*} Weighted average distribution cost = (Market share of gasoline * Distribution cost of gasoline) + (Market share of diesel * Distribution cost of diesel)

Figure 2-27: Biofuels Distribution and End Use Gantt Chart

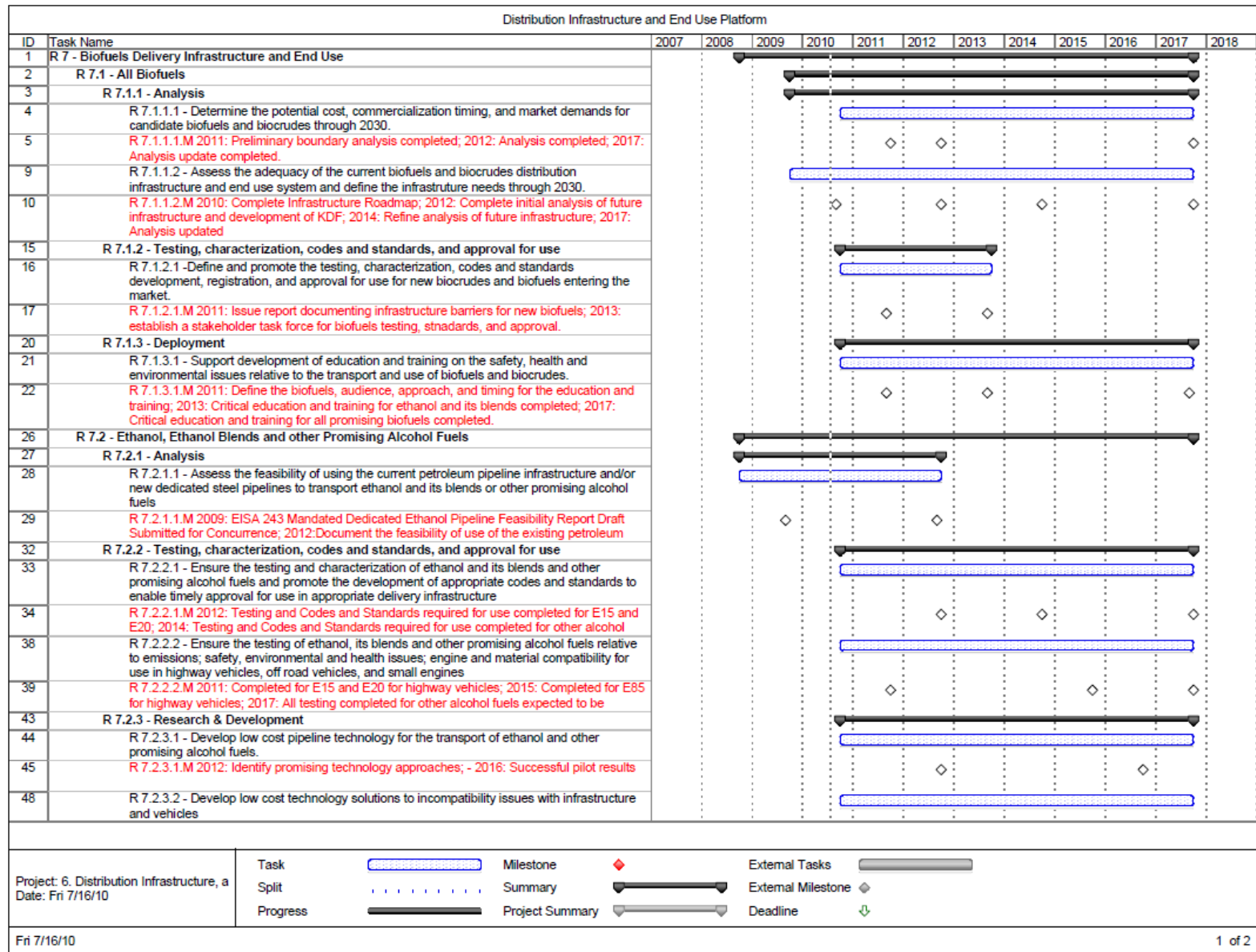

Distribution Infrastructure and End Use Platform													
ID	Task Name	2007	2008	2009	2010	2011	2012	2013	2014	2015	2016	2017	2018
49	R 7.2.3.2.M 2012: Identify and prioritize issues for research; 2017: Develop low-cost technology solutions to enable cost effective delivery of alcohol fuels						◇						◇
52	R 7.2.4 - Deployment												
53	R 7.2.4.1 - Support and promote the expansion of infrastructure and use of ethanol and other promising alcohol fuels												
54	R 7.2.4.1.M 2011: Establish plan and approach; 2015: Adequate numbers of dispensers for E15, E20, and E85 are deployed; 2017: Complete deployment plan executed.					◇				◇			◇
58	R 7.3 - Renewable Fuels and Intermediates												
59	R 7.3.2 - Testing, characterization, codes and standards, and approval for use												
60	R 7.3.2.1 - Confirm the compatibility of renewable gasoline, diesel, and jet fuels with the existing petroleum infrastructure and conventional vehicles												
61	R 7.3.2.M 2012: Initial testing complete and additional testing requirements defined for most promising fuels; 2017 All testing complete for most promising fuels.						◇						◇
64	R 7.3.2.2 - Test and characterize liquid biocrudes (e.g. pyrolysis oil) for compatibility with potential transport infrastructure												
65	R 7.3.2.2.M 2013: Complete testing on py-oil; 2017: complete testing on promising biocrudes							◇					◇
68	R 7.3.2.3 - Promote and ensure the development of appropriate codes and standards and specifications for renewable fuels and biocrudes to enable their commercialization												
69	R 7.3.2.3.M - 2017: Codes and standards, specifications, and approval for use completed for the most promising renewable fuels and their biocrudes												◇ 9/30
70	R 7.3.3 - Research & Development												
71	R 7.3.3.1 - Research and develop low cost technology for the delivery and use of renewable gasoline, diesel and jet fuels												
72	R 7.3.3.1.M 2012: Define appropriate R&D; 2017 Successfully develop the critical technology needed for low cost delivery and use of renewable biofuels.						◇						◇
75	R 7.3.3.2 - Research and develop low cost technology for the transport of biocrudes.												
76	R 7.3.3.2.M 2012: Define appropriate R&D for Py-oil; 2017: Successfully develop the critical technology needed for low cost transport of all promising biocrudes.						◇						◇
79	R 7.3.4 - Deployment												
80	R 7.3.4.1 - Identify markets for and pilot test fuels.												
81	R 7.3.4.1.M 2011: DOD/DESC potential opportunities defined and outlined; 2013 Opportunities beyond DOD identified; 2014: testing initialized.					◇		◇	◇				
85	R 7.4 - Biodiesel												
86	R 7.4.2 - Testing, characterization, codes and standards, and approval for use												
87	R 7.4.2.1 - Facilitate the FAA testing of permissible oxygen content/contamination from biodiesel in jet fuel.												
88	R 7.4.2.1.M - 2017: Testing completed												◇ 9/30
89	R 7.4.2.2 - Fully characterize the solvent power of biodiesel and its blends.												
90	R 7.4.2.2.M - 2017: Testing completed												◇ 9/30
91	R 7.4.3 - Research & Development												
92	R 7.4.3.1 - Develop solutions to concerns around compatibility, cold start, storage, and cloud point.												
93	R 7.4.3.1.M 2012: define required R&D; 2017 Successfully develop the critical technology needed for low cost delivery and vehicle use of FAME biofuels.						◇						◇

Project: 6. Distribution Infrastructure, a Date: Fri 7/16/10	Task		Milestone		External Tasks	
	Split		Summary		External Milestone	
	Progress		Project Summary		Deadline	

Fri 7/16/10 2 of 2

2.5 Biopower

The Biopower technical area of the Biomass Program is focused on developing, optimizing and demonstrating pretreatment and conversion technologies to enable the increased use of biomass for electricity generation to displace fossil fuel and reduce GHG emissions. The program focuses on biopower generation primarily through cofiring up to 20 percent biomass (heat input basis). Cofiring, or co-combustion, refers to the combustion of two different types of materials at the same time.

Biomass currently plays a relatively small role in the U.S. electric generation market and represents about 10 GW of electricity generation.¹⁴ Opportunities exist for cofiring biomass with coal and achieving measurable GHG reductions.¹⁵ Drawing on the DOE capabilities, experience, and lessons learned from its previous biopower R&D activities (1994 -2003),^{16,17,18} and advances made subsequently, the Program will consider improvements throughout the biopower supply chain and invest in RD&D to increase the conversion efficiency, environmental performance, and economic viability of utility-scale biopower applications.

The Biopower activities described in this section support the pilot-scale development of up to 30 MW of advanced biopower generation capacity by 2016.

Biomass Cofiring Technology Description

A simplified process flow diagram for converting biomass to electricity is shown in Figure 2-28.

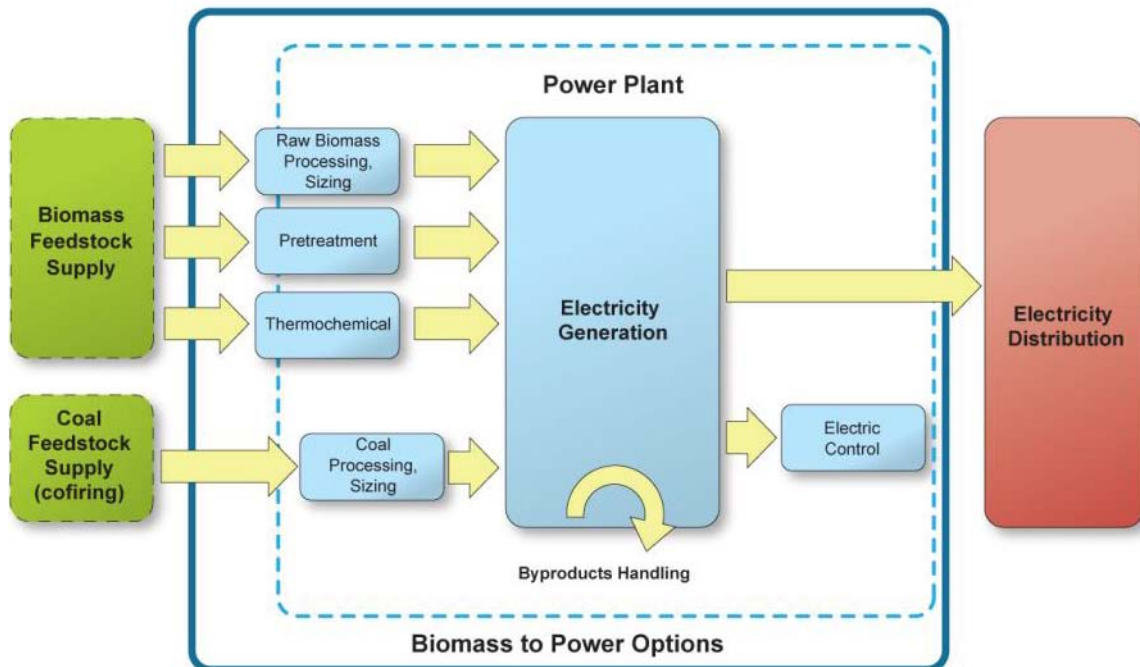

Figure 2-28: Detailed Unit Processes for Biomass to Electricity

Biomass feedstocks are received at the plant or an intermediate processing facility and may be processed in three different ways. The topmost path shown in Figure 2-28 involves minimal

processing and sizing for the material to meet combustor specifications. Properly sized biomass is fed to the boiler which produces steam for a steam turbine that drives an electrical generator to produce electricity. The remaining paths shown in Figure 2-28 undergo one or more additional steps in which the raw feedstocks are pretreated or converted into a form more suitable for long distance transport and advanced technology electricity generation. All paths require byproduct handling and emissions control. The biopower unit operations are described below in more detail.

Feedstock Processing and Sizing: Biomass used for cofiring must meet certain physical size and shape standards. Feedstock processing can take place in the field, at intermediate depot locations, or on site at the power plant.

Pretreatment and Conversion: Pretreatment and conversion processes are used to upgrade raw feedstocks into intermediate forms that can improve overall power generation cycle efficiency, achieve net carbon benefits, add greater flexibility for conversion of existing power plant assets, reduce barriers related to transport of raw biomass, and allow them to be used with advanced power cycle generation technologies. The bio-oil or syngas intermediates generated for biopower applications have the advantage of requiring less upgrading than biofuel applications and are therefore, cheaper to produce. Biochar, a byproduct of pyrolysis processes, can be used as a soil amendment and as a carbon sequestration option.

Table 2-11 lists various pretreatment and conversion options to upgrade biomass feedstocks for power generation.

Table 2-11: Process Options for Upgrading Biomass

Process	Benefit
Pelletization: Drying and mechanical compression	Improves energy density and storability of the feedstock
Torrefaction: Feedstock drying, heat treating and pelletizing/briquetting	Improves energy density, grindability, stability, and storability of the feedstock
Gasification: Pyrolysis and partial oxidation, gas cleanup	Provides a low to medium BTU fuel gas compatible with gas turbines and other advanced combustion systems
Fast Pyrolysis: Pyrolysis to an energy-dense fuel oil	Provides a liquid fuel that is easy to inject into conventional and advanced power generation systems

Byproducts Handling: Ash from biomass power conversion processes using woody feedstocks is generally considered benign and may have value as a soil amendment or fertilizer ingredient. Ash from co-mingled biomass and coal does not meet current ASTM standards for cement production, potentially hurting the economics for some cofired plants. Ash from other resources such as MSW may have more restrictions.

Emissions Control: The emissions from biopower, with or without coal, must meet regulatory standards, requiring an understanding of the biomass's effect on existing total suspended particulates (TSP), SO₂ and NO_x, CO₂ emissions and control systems. The CO₂ emissions profile of plants implementing cofiring may change (on a kW basis).

Electricity Generation: Biopower is currently produced by electric utilities and also by industries such as pulp/paper companies which use low-value biomass to generate electricity for internal use.¹⁹ Typically, these system capacities range from a few hundred kW_e to utility-scale facilities in the range of about 10 – 50 MW_e. Such facilities have net electric conversion

efficiencies ranging from less than 15 percent up to about 30 percent. In comparison, coal-fired electric plants are typically larger (>100 MW_e) and have conversion efficiencies as high as 35 percent. Biomass can also be cofired with coal in conventional combustion/steam cycle facilities providing a low cost option for reducing green house gas (GHG) emissions.

Current biopower applications typically utilize woody biomass in conventional combustion / steam cycle processes. Biomass can either be mixed with the coal outside the combustor, then cofired (direct fired) or combusted separately (indirect fired). Utilizing greater than 5 percent raw biomass (heat input basis) mixed with coal requires significant plant and boiler modifications and is generally limited to a maximum of 15 percent. A direct cofired power plant, as shown in Figure 2-29, is the most likely near-term option for increasing the amount of biomass power generation in the U.S.

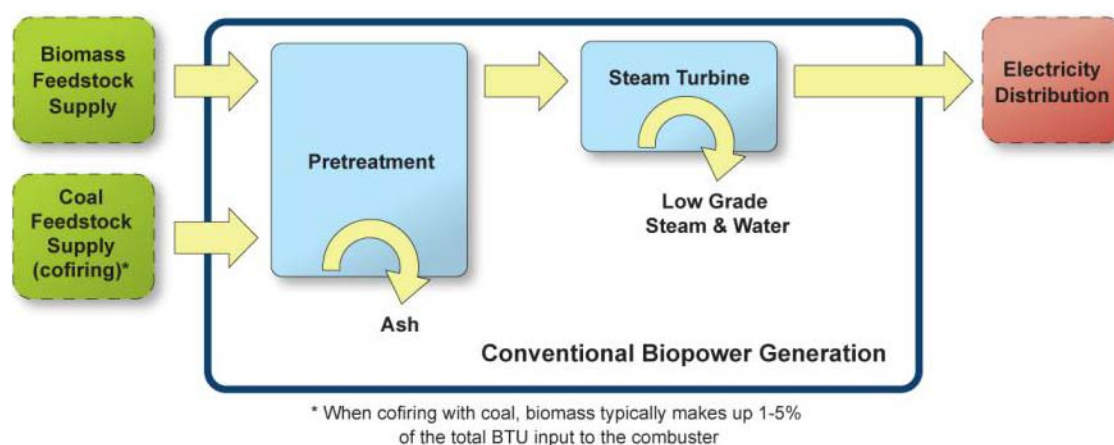

Figure 2-29: Conventional Biopower Generation (simple combustion/steam cycle)

Improvements in cofiring to reduce parasitic losses (in-plant electrical use) and increase system efficiency include supplemental suspension firing (direct injection), gasification reburn, and the use of pretreated feedstocks and intermediates to upgrade the biomass fuel which is then comingled with coal prior to combustion.

Advanced power cycles and systems are capable of higher efficiency power generation (>40 percent) with improved environmental profiles. These applications include combined cycles and advanced gas turbines, and generally utilize biomass resources more effectively. When upgraded biomass fuel intermediates are integrated and optimized for use in advanced power conversion systems, plant energy output, environmental benefits, and performance efficiency improves.

The advantage of fuel intermediates like syngas and bio-oil for advanced biopower applications is that they require less upgrading and “clean-up” than is required for biofuel applications, and as such, these applications have reduced capital requirements. Crude syngas and bio-oil can be used as fuel for a combustion boiler with little upgrading. Similarly, crude syngas produced from biomass can undergo additional upgrading and be fed directly as fuel to a gas combustion turbine in an integrated gasification combined cycle application, as shown below in Figure 2-30.

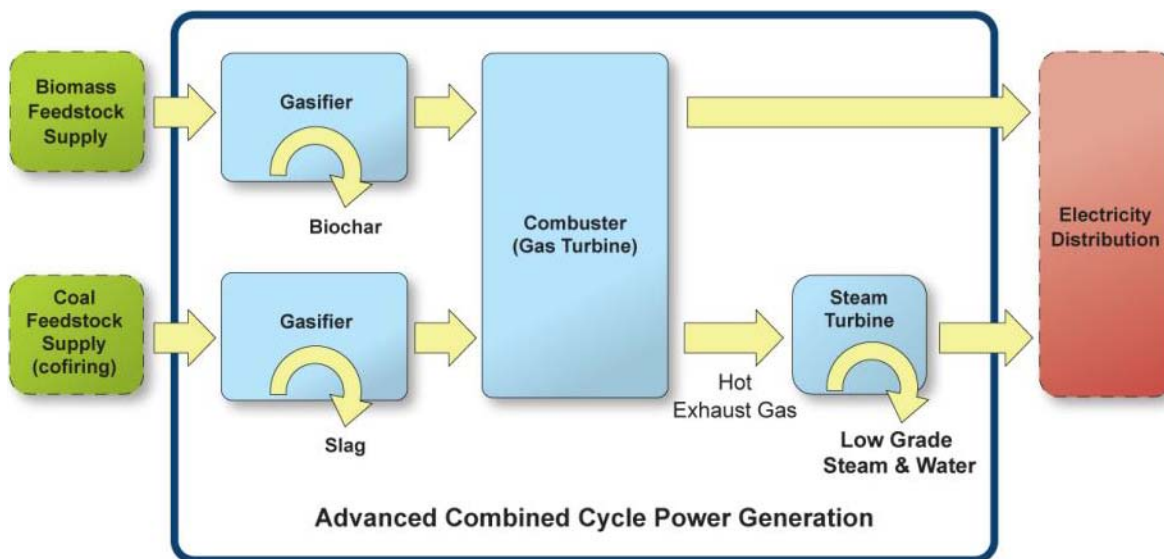

Figure 2-30: Integrated Combined Cycle Power Generation

Biopower Interfaces

Feedstock Supply Interface: Feedstock Supply R&D provides preprocessed feedstocks that meet the requirements (composition, quality, size, moisture content, etc.) as defined by the specific process configuration, while providing data on feedstock availability, sustainability, and logistics. The Feedstock Supply R&D also addresses the processes for storing, handling, milling, and feeding raw biomass. Close coordination between Feedstock Supply and Biopower is required to supply adequate feedstock in an appropriate quality and form to the biopower facility.

Thermochemical Conversion Interface: Thermochemical Conversion R&D provides improved pyrolysis and gasification processes and expertise on the converted intermediates used in biopower and the characterization and use of biochar from pyrolysis processing. Biopower R&D provides the requirements for bio-oil and syngas purity levels and compatibilities suitable for biopower equipment.

2.5.1 Biopower Support of Program Strategic Goals

The Program's Biopower activities support the national goals of reducing GHG emissions through the use of biomass. The Biopower strategic goal is *to conduct a focused RDD&D program to improve cost and performance (energy efficiency, system reliability, and environmental attributes) of utility-scale biomass power generation. Supporting objectives include: (1) enabling the use of upgraded biomass for cofiring advanced high efficiency biopower generation and (2) demonstrating the advantages of biomass cofiring as economic and replicable means of adding large-scale baseload renewable capacity and GHG reduction.*

Working in partnership with stakeholders, the Program will consider cost-shared activities to scale up and demonstrate critical technologies to assist in market expansion. Biopower addresses and supports production of power in the Forest Resources Processing, Agricultural Residues Processing, Energy Crops Processing, and Municipal Solid Waste Processing pathways.

2.5.2 Biopower Support of Program Performance Goals

The Biopower technical area has four overall performance goals, corresponding to its primary thrusts of RD&D. Each goal relates to the overall goal of demonstrating reduced GHG emissions through increasing the amount of biopower generation above the 2010 baseline by FY2020.

- By 2011, develop specifications for improved feedstock quality for materials suitable for use in advanced power generation approaches.
- By 2014, develop pretreatment and conversion technologies to produce upgraded biomass materials.
- By 2015, initiate operation of 10 MW advanced pilot-scale biopower generation and verify associated GHG reductions.
- By 2016, initiate operation of an additional 20 MW of advanced pilot-scale biopower generation and verify associated GHG reductions.
- By 2016, develop pretreatment and conversion technologies capable of increasing the share of biomass mixed with coal to at least 20 percent (heat input basis).

A detailed evaluation of the RD&D necessary to accomplish these goals is in progress. This information will be used to identify additional cost and performance projections.

2.5.3 Biopower Challenges and Barriers

Market Challenges and Barriers

Pm-A. Cost of Biopower Production: Generating electricity from biomass is more expensive than generating from coal. This is especially true compared to coal used for baseload generation, which biomass could potentially directly replace more easily than other renewable resources. Numerous handling, processing, and logistical steps in delivering the feedstock adds to the cost of using biomass. Reductions in production costs along the entire biopower supply chain, including feedstock supply, transport, pretreatment and conversion processes, and power generation, are needed to make biopower competitive with coal-based power.

Pm-B. Need for Consistent Policy Drivers and Regulations: The lack of federal policy supporting renewable energy, such as renewable portfolio standards (RPS), proposed EPA maximum available control technology (MACT) rules and GHG emissions control such as a carbon cap, impede the development of biomass for power generation. Many states have enacted their own RPS legislation, yielding an inconsistent mix of renewable energy implementation requirements and timetables. These programs have been important drivers for considering biopower in meeting their renewable generation mandates. The need for clear policy guidance is critical to the advancement of biomass use in utility-scale power.

Technical Challenges and Barriers

Pt-A. Cofiring Challenges: Technical challenges for utilizing boilers designed for coal include: fuel sizing, fuel handling and injection, increased mass flow rates, carbon conversion, and

emissions control issues, especially particulate and catalyst controls for NO_x and potentially CO₂. Torrefying biomass minimizes the need for separate grinding operations from that of coal resulting in additional cost savings. Cofiring poses numerous challenges to boiler operations stemming from differing fuel properties of biomass and coal when combusted.

Pt-B. Need for Understanding of Environmental Tradeoffs: Electric utilities need clarification that cofiring for power generation will be deemed environmentally acceptable. Understanding the overall changes in emissions from biomass cofiring will be critical to the acceptance of biopower as a sustainable renewable energy source.

Pt-C. Lack of Experience and Understanding of Impacts of Using Biomass and Engineered Biomass as Fuels: Utilities and Independent Power Producers (IPP) in the U.S. have limited knowledge and experience regarding the performance, characteristics, and impacts upon existing emissions equipment and the fly ash content resulting from using large quantities of upgraded biomass. The variable composition of different feedstocks, and the lack of complete standardized specifications of upgraded biomass and best practices regarding their use will impede their consideration. The long lead times associated with developing and understanding new feedstock forms for existing coal plants will delay commercialization and deployment.

Pt-D. Generating Upgraded Biomass for Power Plant Compatibility: Raw biomass feedstocks are not as dry, energy dense, or consistent a fuel source as coal. They are often incompatible with existing plant storage, handling, milling, and fuel feed systems. Many handling operations are required to make the biomass suitable for use. The challenge is to make raw feedstocks into a more cost-effective power source requiring fewer infrastructure modifications. The development and demonstration of raw feedstock pretreatment and conversion processes, that can produce solid, liquid or gaseous fuels on a cost-competitive basis, are needed to improve performance of cofired power plants and advanced cycle systems. The barriers to creating bio-oil via pyrolysis and syngas via gasification are discussed in depth in Thermochemical Conversion R&D [Section 2.2.2.3](#).

Pt-E. Advanced Conversion Challenges: Advanced conversion systems (combined cycles, advanced gas turbines, reciprocating engines, and fuel cells) could be used for biopower if the fuel could be converted to a form and composition compatible with those technologies. Issues such as integrating biomass at high temperatures and pressures and designing new and better fuel feed systems must be addressed. Feedstock conversion systems must be proven and scaled up to provide the necessary upgraded fuel forms required. Improvements in technology to economically produce these solid, liquid, or gaseous biomass-derived fuels and integrating them into advanced conversion systems will be critical. This will allow the industry to leverage the considerable research done by others to develop and improve the power conversion technologies.

Pt-F. End-to-End Process Integration: Successful demonstration of large-scale biopower is dependent on advances in pretreatment and thermochemical conversion process technologies and their subsequent integration into advanced power systems. The demonstration, optimization, and validation of integrated processes, from feedstock production through biomass conversion to power distribution, are required to prove the economic and operational viability of biopower technologies and encourage their adoption by industry.

2.5.4 Biopower Approach for Overcoming Challenges and Barriers

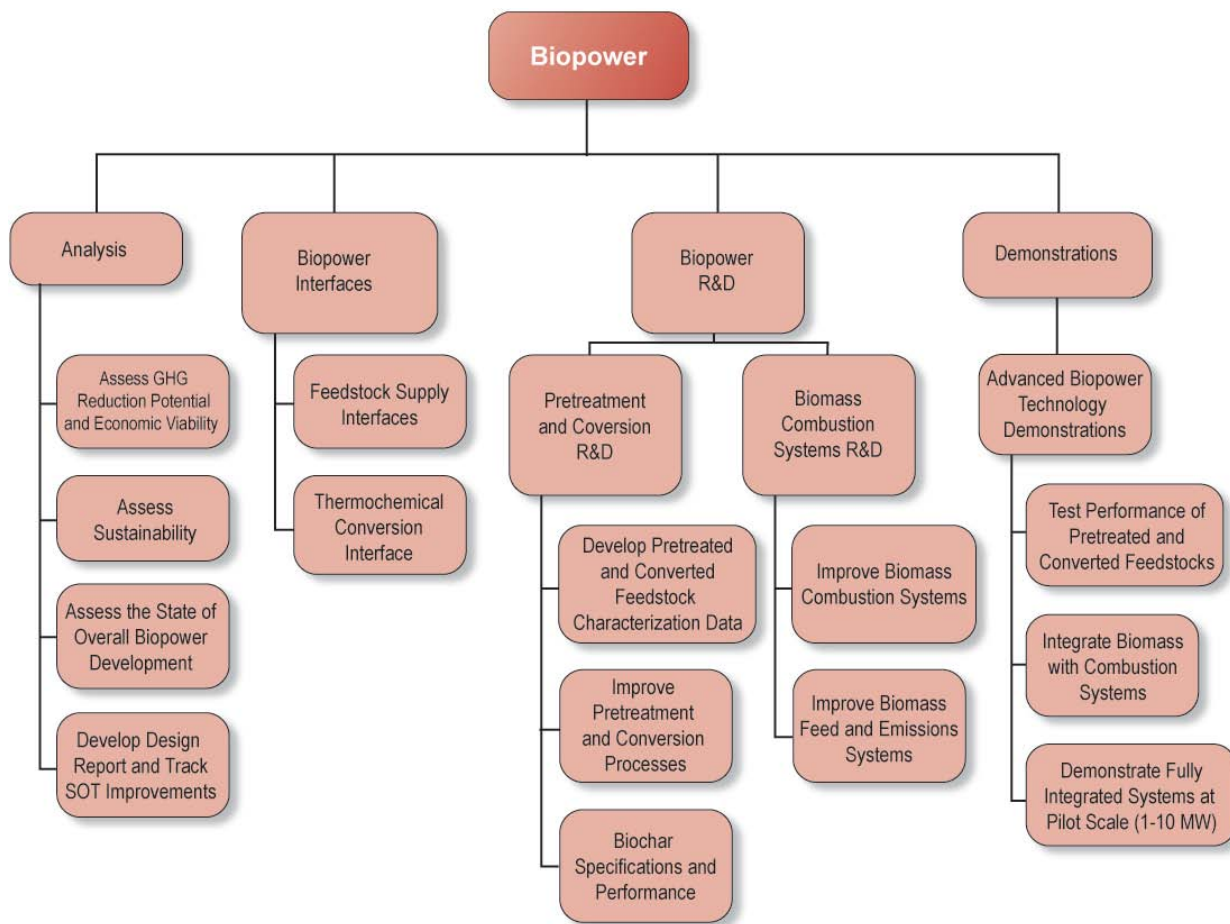

Figure 2-31: Work Breakdown Structure for Biopower Core RD&D

The approach for overcoming technical challenges and barriers is outlined in the Biopower work breakdown structure (WBS) shown in Figure 2-31. Biopower has four key areas which are further broken down into activities described below and in Table 2-12.

The Program's near-term focus is on prioritizing technical R&D efforts through industry and expert input and analysis, and on investigating strategies for high percentage cofiring of biomass with coal, including initial testing of upgraded biomass for these applications. Mid-term R&D efforts focus on the development and scale up of processes to produce upgraded biomass and coupling them with advanced biopower technologies at several pilot-scale units, demonstrating capability of improved overall power generation and operational efficiencies.

Research and development which addresses key technical barriers will be performed by national laboratories, universities, and industry. Demonstrations will be conducted through partnerships with industry and other stakeholders, as well as through collaborations with the DOE Offices of Fossil Energy and Electricity Delivery and Energy Reliability.

Analysis (Pm-A, Pm-B, Pt-A, Pt-B, Pt-C, Pt-D, Pt-E, Pt-F)

Biomass has demonstrated the potential to grow into a significant source of power renewable power generation. To enable this, the Program will focus on assessing the state of technology, market readiness, potential policy and regulatory impacts, and barriers to the use of biopower, while understanding the cost, performance, feedstock sustainability, and logistical issues related to biopower, including best practices and global developments. Plans include establishing a database of information derived from past, ongoing, and future RDD&D and analysis that will assist industry in assessing its applicability; performing detailed lifecycle analyses to provide certainty on issues surrounding carbon accounting and sustainability; as well as other issues such as feedstock availability and impacts of varying supply and demand.

Biopower Interfaces (Pm-A, Pt-A, Pt-B, Pt-C, Pt-D, Pt-E, Pt-F)

- **Feedstock Supply Interface**

The Feedstock Supply activities focus on assessing sustainable feedstock supply levels against projected feedstock demand from biopower and developing feedstock specifications and processing requirements. It also includes R&D to improve the storing, handling, processing, and feeding of raw biomass while minimizing associated costs.

- **Thermochemical Conversion Interface**

The Thermochemical Conversion activities focus on improving pyrolysis and gasification processes to generate liquid (bio-oil) and gaseous (syngas) intermediates from biomass.

Biopower R&D (Pm-A, Pt-A, Pt-B, Pt-C, Pt-D, Pt-E, Pt-F)

- **Pretreatment and Conversion R&D**

Biopower R&D activities focus on developing improved and cost-effective pretreatment and conversion processes to improve overall power generation cycle efficiency, lower overall production costs, and reduce GHG emissions. These activities will provide solid, liquid, and gaseous fuels with more consistent and desirable chemical compositions for handling and firing for coal power plants and advanced power technologies, while offering greater conversion flexibility for existing power plants from coal to biomass.

Pelletization and torrefaction are the major forms of pretreatment being investigated, and pyrolysis and gasification will be leveraged through the Thermochemical Conversion Interface. The potential benefits of biochar as a soil amendment and carbon sink will also be explored.

- **Biomass Combustion Systems R&D**

Biopower works to improve boiler availability, combustion and heat transfer, and conversion efficiency for the cofeeding of biomass with coal. Biopower will conduct combustion system R&D to resolve technical issues relating to biopower boiler operations and to mitigate technical challenges resulting from introducing biomass in coal boilers. Challenges include slagging and fouling of heat transfer surfaces due to increased alkaline metals, higher volatile matter content, lower heating values, higher moisture content, and higher chlorine levels in the biomass as compared to coal. Existing feed and emissions control systems will be

evaluated to increase compatibility with biomass, and the development of improved combustion burners and combustion kinetics will be examined. Certification of bio-ash for use under ASTM standards will also be performed.

Demonstration (Pm-A, Pt-A, Pt-B, Pt-C, Pt-D, Pt-E, Pt-F)

- **Advanced Technology Demonstrations**

The Program's Biopower activities focus on demonstrating high percentage, utility-scale cofiring to validate successful cofiring with up to 20 percent biomass/coal, while minimizing boiler efficiency losses and impacts on pollution control equipment. Efforts also focus on facilitating the adoption of technology improvements such as the use of upgraded biomass. Biomass pellets and torrefied briquettes will be tested to evaluate compatibility and validate the economic and environmental value of biomass as a viable power fuel source.

Advanced technology demonstrations will focus on proving that upgraded biomass can work and the process can be scaled up to provide utility-scale biopower. Efforts include testing the performance of torrefied briquettes, biomass pellets, bio-oil, and syngas in advanced technologies. Once tested, the advanced technology combustion systems will be integrated with the most appropriate upgraded biomass.

Utilizing a combination of advancements in power plant technology, fuel processing modifications, and combustion compatibility improvements, scale up to the pilot-scale plant level (1 – 10 MW) will be performed. These advanced technology demonstrations will be focused on system performance validation at scales and operating periods, permitting informed investment decisions for continued scale-up and eventual commercialization.

2.5.5 Prioritizing Biopower Focus

The Biomass Program aims to develop a diverse portfolio of technologies to facilitate the adoption of biopower solutions throughout the U.S. The Program will develop a variety of pathways to achieve the goals and will focus on identifying and selecting those efforts with the lowest risks and highest opportunities for widespread replication and economic value.

A Biopower Gantt chart provides a detailed milestone schedule in Figure 2-32.

Table 2-12: Biopower Activity Summary

Goal: Conduct a focused RDD&D program to improve cost and performance of utility-scale biomass power generation.				
WBS Element	Activities	Barrier(s) Addressed	FY 10 Performers	Feedstock Pathways
Analysis	<p>Assess sustainability of biopower systems:</p> <ul style="list-style-type: none"> • Conduct GHG accounting • Assess techno-economic and lifecycle impacts <p>Develop design reports and SOTs to understand unit operations:</p> <ul style="list-style-type: none"> • Develop a baseline for existing key technologies and assess new and emerging processes • Identify process points of greatest cost sensitivity • Monitor industry trends in policy and technology 	Pm-A: Cost, Pm-B: Policy Drivers, Pt-A: Cofiring, Pt-B: Environmental Tradeoffs, Pt-C: Understanding Impacts of Using Biomass as Fuels, Pt-D: Generating Upgraded Biomass, Pt-E: Advanced Conversion Challenges, Pt-F: Process Integration, St-C: Sustainability Data across the Supply Chain, St-E: Sustainability Best Practices	TBD	<ul style="list-style-type: none"> • Forest Resources • Agricultural Residues • Energy Crops • Municipal Solid Waste
Biopower Interfaces	<p>Develop understanding of feedstock cost & quality and thermochemical process: enhancements. Develop a pathway to optimization and cost reduction.</p> <ul style="list-style-type: none"> • Provide data informing analyses on the availability and sustainability of various feedstock types. Provide preprocessed feedstock that meets the requirements • Improve pyrolysis and gasification technologies to produce upgraded biomass for use in current and future biomass electricity generation facilities 	Pm-A: Cost, Pt-A: Cofiring, Pt-B: Environmental Tradeoffs, Pt-C: Understanding Impacts of Using Biomass as Fuels, Pt-D: Generating Upgraded Biomass, Pt-E: Advanced Conversion Challenges, Pt-F: Process Integration	TBD	
Biopower R&D	<p>Develop an understanding of upgraded biomass and improve the processes used to create and combust them:</p> <ul style="list-style-type: none"> • Develop specifications data and pretreatment and conversion technologies for upgraded biomass • Improve feedstock preprocessing technologies to produce high density solid, liquid and gaseous feedstocks for biopower combustion systems • Improve near-term combustion and gasification systems for accommodating biomass that improve the boiler availability and conversion efficiency • Improve thermal kinetics and combustion characteristics of using biomass and biomass derived fuels • Improve high throughput injection systems for biomass and biomass coal mixtures • Determine impact of combustion of biomass on emission control equipment (cofiring) • Evaluate use of biochar byproducts for sequestration potential 	Pm-A: Cost, Pt-A: Cofiring, Pt-B: Environmental Tradeoffs, Pt-C: Understanding Impacts of Using Biomass as Fuels, Pt-D: Generating Upgraded Biomass, Pt-E: Advanced Conversion Challenges, Pt-F: Process Integration	TBD	
Demonstration	<p>Demonstrate cofiring and advanced biopower conversion technologies:</p> <ul style="list-style-type: none"> • Demonstrate high-rate cofiring (at least 20 percent) at existing sites • Advances in solid, liquid and gas phase upgraded biomass development, integrated with advanced cycles and combustion technologies • Advanced biopower technologies demonstrated at pilot scale (1-10 MW) • Characterize feedstock performance in biopower combustion systems 	Pm-A: Cost, Pt-A: Cofiring, Pt-B: Environmental Tradeoffs, Pt-C: Understanding Impacts of Using Biomass as Fuels, Pt-D: Generating Upgraded Biomass, Pt-E: Advanced Conversion Challenges, Pt-F: Process Integration	TBD	

Figure 2-32: Biopower Gantt Chart

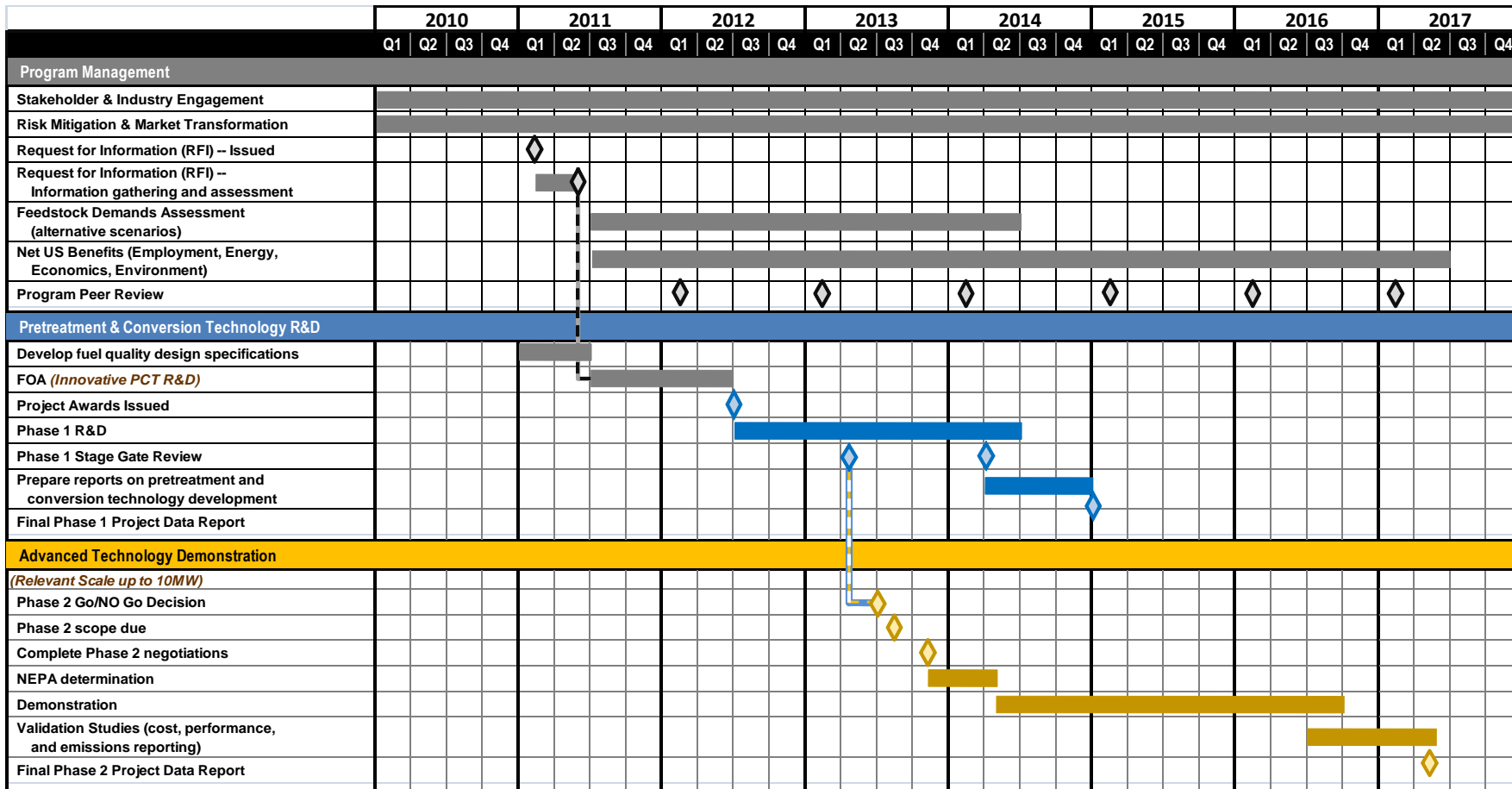

2.6 Sustainability

The Biomass Program is focused on developing the resources, technologies, and systems needed to grow a biofuels industry in a way that protects our environment. While oil displacement is at the core of the Program’s mission, a shift beyond renewable energy to also address long-term sustainability is increasingly important. The existing and emerging biofuels industry will need to invest in systems based not just on economic viability and market needs, but on more overarching concerns such as food security and environmental sustainability. To that end, the Biomass Program is articulating the challenges related to sustainable bioenergy production and use and working through its partners to address these challenges through basic and applied research and analysis.

Executive Order 13514 (Federal Leadership in Environmental, Energy, and Economic Performance) provides the following definition for sustainability and sustainable – “To create and maintain conditions, under which humans and nature can exist in productive harmony, that permit fulfilling the social, economic, and other requirements of present and future generations.” Maintaining the services provided by natural resources, promoting economic development, and providing conditions that support human and societal health are all critical components of a sustainable bioenergy industry.

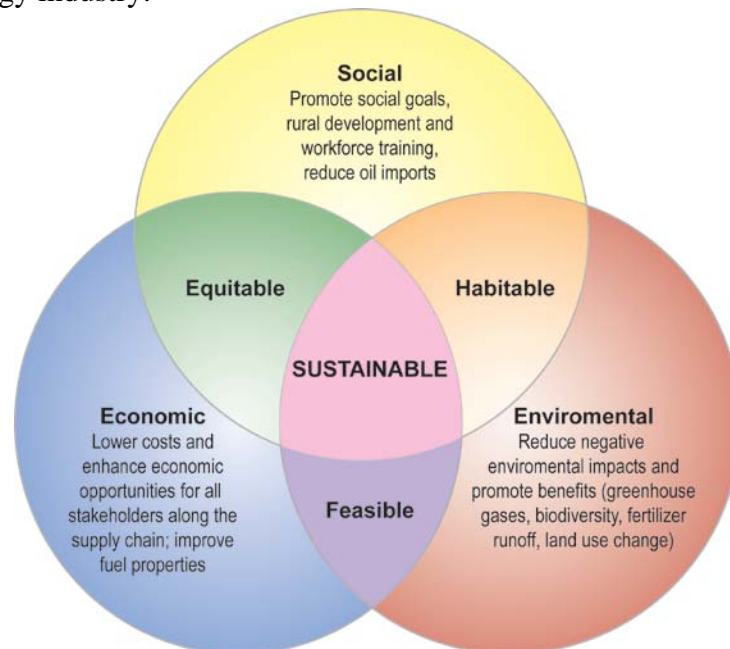

Figure 2-33 Biomass Program Sustainability Scope

Based on this mandate, Biomass Program’s Sustainability efforts are organized around environmental, social, and economic dimensions – the three core aspects of sustainability. With activities in all three areas, the Program can ensure sustainability along the entire biomass-to-bioenergy supply chain and enable a sustainable bioenergy industry over time (see Figure 2-34). When these three aspects of sustainability are examined pair-wise additional characteristics are illustrated:

Equitable (social and economic)—Both the social and economic dimensions are fulfilled when economic benefits are distributed among all members of society;

Feasible (economic and environmental)—To be feasible, any resource, technology, or system that reduces negative environmental impacts and that promotes benefits should also be economically competitive

Habitable (social and environmental)—Achieving environmental benefits leads to societal benefit through the maintenance of ecosystem services and ensuring that people have healthy places to live and work.

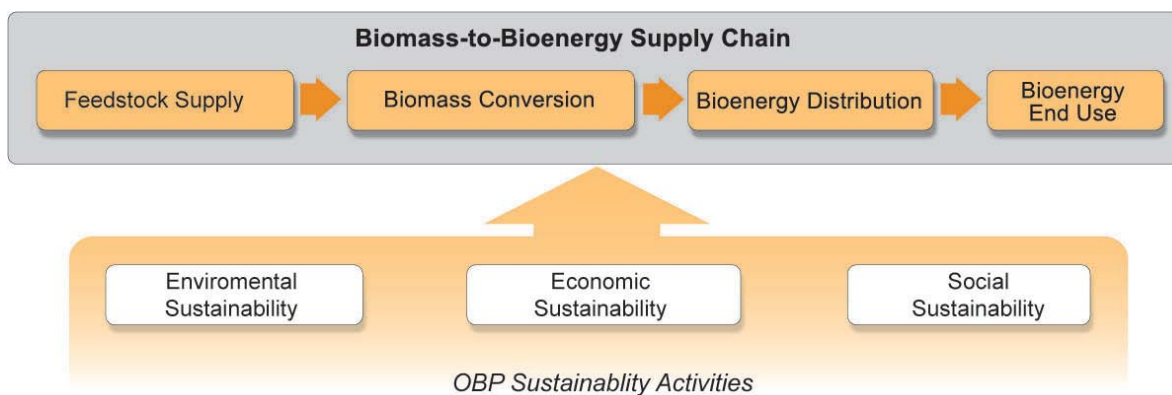

Figure 2-34: Sustainability Activities Crosscut All Biomass-to-Bioenergy Supply Chain Elements

Environmental Sustainability

Environmental sustainability activities are focused in several key areas. Certain environmental categories such as soil quality and biological diversity are focused on feedstock production, while others, such as water and air quality, as well as land use should be monitored along the entire bioenergy supply chain. These categories and their associated objectives are outlined below:

- Climate: Reducing greenhouse gas emissions associated with biofuel production and use
- Soil quality and agronomics: Maintaining or improving soil quality and land productivity
- Water quality and quantity: Increasing water use efficiency and maintaining or improving water quality
- Air quality: Maintaining or improving air quality
- Biological diversity: Conserving biological diversity
- Land use: Minimizing negative land use change impacts

Economic Sustainability

The primary goal of the Program is to promote an economically viable bioenergy industry in the United States. Therefore, several economic sustainability categories are critical for measuring progress towards this goal. Beyond profitability, the Program also relies heavily on measurements of efficiency and productivity when assessing and documenting state of technology for new bioenergy pathways. Economic sustainability is deeply interwoven into the Program's cost target structure, and therefore, is not a separate focus of cross-cutting

sustainability efforts. However, the interaction between economic sustainability and the other two components (social and environmental) is covered under Systemic Sustainability.

Social Sustainability

Social sustainability, an often overlooked component, is critical to ensure that development of the bioenergy industry aligns with societal values and promotes social goals. For example, much of the recent support given to biofuels has been focused on their ability to promote energy security through reducing U.S. dependence on foreign oil. Thus, the contribution of bioenergy to energy security and to the associated societal value and benefits means that bioenergy is implicitly socially sustainable. While social sustainability is not necessarily core to the Biomass Program's mission and efforts, much of the Program's activities are intrinsically related to the social benefits of bioenergy. Impacts from Program's efforts that are directly aligned with social sustainability are as follows:

- Energy diversification and security: Reducing dependence on foreign oil and increased energy supply diversity
- Energy access: Increasing access to affordable energy
- Net energy balance: Demonstrating positive net energy balance relative to fossil fuels
- Rural development and workforce training: Ensuring a trained workforce and promoting rural livelihoods

Systemic Sustainability

Systemic sustainability represents an explicit consideration of the relationship within and between the sustainability categories above. One example would be optimizing for both economic and environmental sustainability in order to find the most feasible outcome.

In order to understand and address the environmental, social, and economic benefits and impacts of bioenergy production, the Biomass Program works closely with other federal agencies whose missions incorporate bioenergy. In particular, the program partners closely with the U.S. Department of Agriculture (USDA), the Environmental Protection Agency (EPA), and the Department of Transportation (DOT). The Biomass program is also actively involved in international dialogue on sustainable bioenergy through the Global Bioenergy Partnership (GBEP) Sustainability Working Group and the Roundtable on Sustainable Biofuels (RSB).

While other federal agencies have activities related to select focus areas along the supply chain, such as feedstock production for USDA, and infrastructure and end use for DOT, the Biomass Program addresses the integration amongst all dimensions of sustainability and all supply chain components, i.e., enabling the *integrated biorefinery*. The Program is focused on evaluating all that goes into a sustainable integrated biorefinery – feedstock production and logistics (sustainable supply), conversion unit operations, and the infrastructure for delivery of fuel, power, and products from the biorefinery facility to end use. Data integration is critical to anticipating environmental, economic, and social impacts of the industry as a whole and for specific feedstock-to-energy pathways.

2.6.1 Sustainability Support of Biomass Program Strategic Goals

The Biomass Program's overarching strategic goal is to *develop sustainable cost-competitive biomass technologies to enable the production of bioenergy nationwide and reduce dependence on oil through the creation of a new domestic bioenergy industry, supporting the EISA goal of 36 billion gallons per year of renewable transportation fuels by 2022 and increase biopower's contribution to national renewable energy goals through increasing biopower generating capacity.*

Sustainability is an integral part of the Biomass Program's vision and strategic goal. The Sustainability strategic goal is *to understand and promote the positive economic, social, and environmental effects and reduce the potential negative impacts of bioenergy production activities.*

Sustainability Activities Interfaces

Sustainability activities interface with and impact all elements of the biomass-to-bioenergy supply chain and at each stage of the development of bioenergy.

2.6.2 Sustainability Support of Program Goals

The overall performance goals for Sustainability are as follows:

- By 2012, identify metrics and set targets for climate, water, and land use for agricultural residues, energy crops, and forest resources pathways.
- By 2013, identify metrics and set targets for soil quality and air quality for agricultural residues, energy crops, and forest resources pathways.
- By 2022, evaluate, quantify, and document sustainable integrated pilot performance along the agricultural residues, energy crops, and forest resources pathways.

The performance goals for the pathways under investigation are:

Analysis

- By 2012, establish baseline and targets for all sustainability categories for the integrated biomass to biofuel process for agricultural residues, energy crops (woody or herbaceous), and forest resources.
- By 2017, evaluate and compare the sustainability of agricultural residues, energy crops, and forest resources pathways for biofuel production.
- By 2022, evaluate and compare the sustainability of biofuel production pathways.

Demonstration

- By 2015, demonstrate sustainable production of biofuel from agricultural residues at pilot scale including all sustainability categories.
- By 2017, demonstrate sustainable production of biofuel from woody or herbaceous energy crops at pilot scale including all sustainability categories.
- By 2022, demonstrate sustainable biofuel production from all feedstocks.

Best Practices Deployment

- By 2017, implement best practices for all sustainability categories for a sustainable integrated biomass-to-biofuel process for agricultural residue.
- By 2022, implement best practices for all sustainability categories for a sustainable integrated biomass to bioenergy process for energy crops (woody or herbaceous) and forest resources.

2.6.3 Sustainability Technical Challenges and Barriers

St-A. Scientific Consensus on Bioenergy Sustainability: While there is agreement on the general definition of sustainability, there is no consensus on its specific definition or ways to quantify how bioenergy sustainability should be measured (such as definitions, approaches, system boundaries, and time horizons).

St-B. Consistent, Defensible Message on Bioenergy Sustainability: The prevalence of misrepresentations of the effects of bioenergy – including assumptions, scenarios, and model projections that lack empirical underpinnings – creates confusion about the benefits of bioenergy production and leaves the industry vulnerable to criticism.

St-C. Sustainability Data across the Supply Chain: A fundamental hurdle is the lack of data to evaluate sustainability along the supply chain and to compare effects of one pathway with another. The lack of adequate and accessible temporal and spatial data for measuring sustainability hinders other critical activities such as establishing baselines, determining targets for improvement, recommending best practices, and evaluating tradeoffs.

St-D. Indicators and Methodology for Evaluating Sustainability: There is little agreement about operationally practical and effective methods to develop metrics, define baselines, set targets, and conduct lifecycle assessments to determine the impacts of bioenergy relative to other energy alternatives.

St-E. Best Practices for Sustainable Bioenergy Production: Because bioenergy production is relatively new, few “best practices” are defined for all components of the bioenergy supply chain.

St-F. Systems Approach to Bioenergy Sustainability: The sustainability of the entire supply chain is not considered in current assessments of technical feasibility and economic optimization. No tools exist to allow researchers to consider the potential interactions and trade-offs among different goals (energy security, biodiversity protection, low-cost commodities) and different bioenergy scenarios.

St-G. Representation of Land Use: The inability of existing data sources to capture the actual state of the landscape, a poor understanding of the processes that drive land-use change (LUC), and the lack of knowledge about the environmental and social consequences of LUC associated with bioenergy production, have undermined efforts to assess the environmental and social effects of bioenergy.

2.6.4 Sustainability Approach for Overcoming Challenges and Barriers

The approach for overcoming biomass sustainability technical challenges and barriers is outlined in the Sustainability area’s work breakdown structure (WBS) as shown in Figure 2-35. The WBS is organized around two areas, Sustainability Analysis and Sustainability Practices and Standards with key subtasks as shown in Figure 2-37.

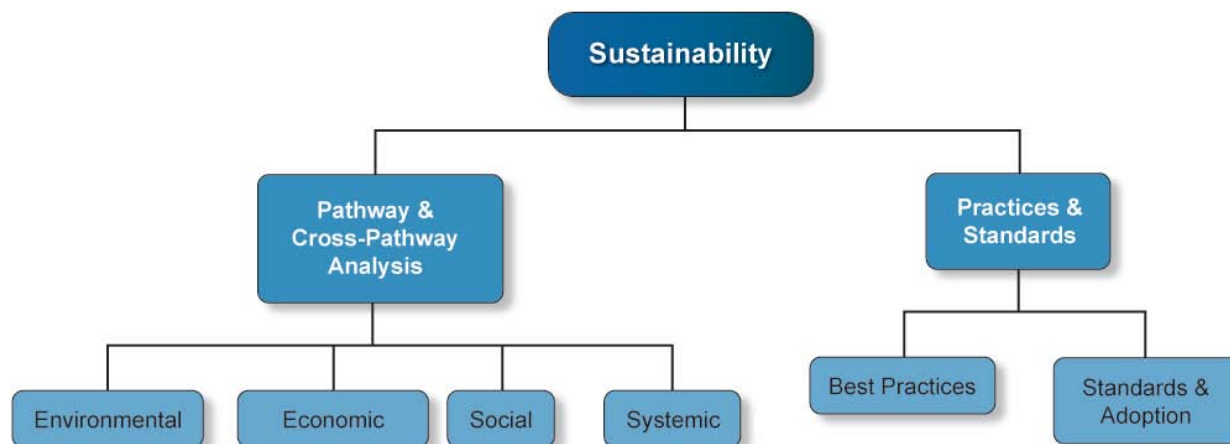

Figure 2.35 Work Breakdown Structure for Sustainability

The R&D approach of each Sustainability WBS task element is described below, while Table 2-13 summarizes each task element’s work as it relates to specific sustainability barriers and biorefinery pathways.

Pathway and Cross-Pathway Analysis

Sustainability Analysis is focused on identifying sustainability indicators, establishing performance baselines and targets, identifying trends, and evaluating trade-offs and progress for technology pathways/routes across the entire supply chain – feedstocks, conversion, distribution, and end use. Environmental, social, and economic sustainability of all pathways will be considered, as well as integration across these aspects of sustainability to enable comparison of various biorefinery pathways (referred to as “cross-pathway analysis”).*

Sustainability Standards and Adoption

This area focuses on developing and evaluating best practices within each technology area and pathway based on monitoring, field data, and modeling results. Practices will be compared with empirical data to support standard setting and adoption of those best practices across the industry. Once the tools/methodologies for evaluating sustainability have been developed, they will be incorporated into the Biomass Program’s technology evaluation approach.

* For additional information on the evaluation of economic sustainability, see [Section 2.7](#)—Analysis.

Table 2-13: Sustainability Activity Summary

Goal: To understand and promote positive economic, social, and environmental effects and reduce the potential negative impacts of bioenergy production activities.				
WBS Element	Description	FY 2010 Performer	Barriers Addressed	Pathways Addressed
Pathway Sustainability Analysis	Identify indicators, establish baselines and targets, and assess progress for technology pathways/routes across the entire supply-chain. Assess indicators for ease and cost of data collection, verification, and comparison, and effectiveness in reflecting the implications of different technologies on goals and priorities.			
Environmental	Identify categories of environmental indicators that reflect goals and priorities to provide comparison among different technology options. <ul style="list-style-type: none"> Identify sustainability indicators for climate, water, and land use Identify metrics and set baselines for soil quality and air quality 	TBD	St-A: Scientific Consensus St-B: Consistent, Defensible Message St-C: Sustainability Data across the Supply Chain St-D: Indicators and Methodology St-G: Representation of Land Use	
Social	Identify categories of social indicators that reflect goals and priorities, and permit the comparisons across different technology options. <ul style="list-style-type: none"> Identify indicators for food security, energy security, physical security, labor rights, cultural and spiritual values, participation, and land rights Evaluate, quantify, and document indicators and their performance 	TBD	St-A: Scientific Consensus St-B: Consistent, Defensible Message St-C: Sustainability Data across the Supply Chain St-D: Indicators and Methodology	<ul style="list-style-type: none"> Wet Mill Improvement Dry Mill Improvement Natural Oils Processing Agricultural Residues Processing Energy Crops Processing Forest Resources Processing Waste Processing Algae
Systemic Sustainability	Identify categories of indicators that reflect goals and priorities for sustainability and permit the comparisons across different technology options. Evaluate using selection criteria for indicators. Assess utility of indicators in terms of their effectiveness in reflecting the implications of different technologies on goals and priorities. <ul style="list-style-type: none"> Determine which indicators address certain goals and priorities Evaluation of indicators against selection criteria Evaluation of the ability of indicators to reflect sustainability of different technologies 	TBD	St-A: Scientific Consensus St-B: Consistent, Defensible Message St-C: Sustainability Data across the Supply Chain St-D: Indicators and Methodology St-F: Systems Approach to Bioenergy Sustainability St-G: Representation of Land Use	
Cross-Pathway Sustainability Analysis	Identify trends and evaluate trade-offs among different indicators and pathways. Test and validate hypotheses and calibrate models against relevant empirical data. Review objectives, indicators, and best practices in light of changing conditions, priorities, and new knowledge. <ul style="list-style-type: none"> Evaluate cross-pathway environmental sustainability Evaluate cross-pathway social sustainability Evaluate systemic sustainability 	TBD	St-A: Scientific Consensus St-B: Consistent, Defensible Message St-C: Sustainability Data across the Supply Chain St-D: Indicators and Methodology St-F: Systems Approach to Bioenergy Sustainability St-G: Representation of Land Use	
Document Best Practices	Develop and evaluate best practices based on monitoring, field data and modeling results. Compare practices with empirical data to support continuous improvement in sustainability.	TBD	St-E: Best Practices	
Sustainability Standards and Adoption	Set standards / promote adoption of best practices	TBD	St-A: Scientific Consensus St-B: Consistent, Defensible Message St-E: Best Practices	

2.6.5 Prioritizing Sustainability Barriers

To enable future data-driven prioritization of sustainability issues, the Biomass Program is focusing on a series of tasks for each sustainability category (climate, soil quality, etc.) and pathway as illustrated in Figure 2-36. In order for sustainability of a particular pathway to be assessed, each task must be completed for each criterion for each relevant supply chain element. Sustainability Program goals have been set based on the maturity of each biorefinery pathway and anticipated technology development.

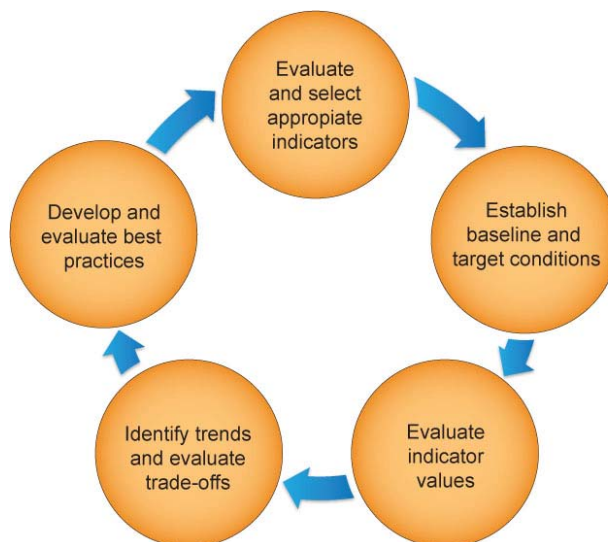

Figure 2-36 Sustainability Activities

Sustainability Activities for Each Biorefinery Pathway

The Program will focus on defining the principles of sustainability within the context of bioenergy production. Some of these principles, such as “Biofuels should have a lower greenhouse gas impact than petroleum-based fuels,” are legislatively mandated (in this case by the Renewable Fuel Standard), while in other cases, the criteria and indicators by which to measure the principle are not yet clearly defined. The initial categories are as follows:

- Environmental Sustainability – Climate, soil quality and agronomics, water quality and quantity, air quality, biological diversity and land use
- Economic Sustainability – Efficiency, productivity, and profitability
- Social Sustainability – Rural development, energy diversification and security, energy access, and net energy balance

For each component of sustainability, a standard or principle will be established by which progress can be measured using indicators. Based on these associated indicators or metrics, best practices will be demonstrated as follows:

- **Evaluate and select appropriate indicators** based on sustainability goals and selection criteria (e.g., cost of data collection and verification, attribution, comparability across pathways, consistency across agencies, etc.). Assess utility in terms of indicator capacity to reflect implications of different technologies on sustainability goals and priorities.
- **Establish baseline and target conditions** consistent with the goals and scales (temporal and spatial) of effects to be measured. Develop scenarios for the evolution of supply,

demand, and consequences with and without program interventions. Establish relevant sustainability targets for each selected indicator to reflect the changes expected as a result of biofuel program requirements.

- **Evaluate indicator values** based on established monitoring protocols and considering relationships between each supply chain element and indicator. Document what is known and unknown about all factors that induce changes in indicator status. Document the presumed degree to which program intervention can impact indicator values.
- **Identify trends and evaluate trade-offs** among different indicators and pathway elements. Test and validate hypotheses and calibrate models against relevant empirical data.
- **Develop and evaluate best practices based on monitoring, field data, and modeling results.** Compare practices with empirical data to support continuous improvement in sustainability. Review objectives, indicators, and best practices in light of changing conditions, priorities, and new knowledge.

Comparison with current and evolving global bioenergy systems is an element of the Program's sustainability activities which enables assessment of benchmark systems from major bioenergy-producing countries.

2.6.6 Sustainability Milestones and Decision Points

The key sustainability milestones, inputs/outputs, and decision points to complete the tasks described in [Section 2.6.4](#) are summarized in the chart in Figure 2-37. The highest level milestones are the performance goals for Sustainability. These performance goals represent the culmination of work from the collection of data at the bench and field scale to the pilot and demonstration scale; analysis and evaluation of baselines and targets; and eventually to implementation of best practices in demonstration- and commercial-scale efforts.

Figure 2-37: Sustainability Gantt Chart

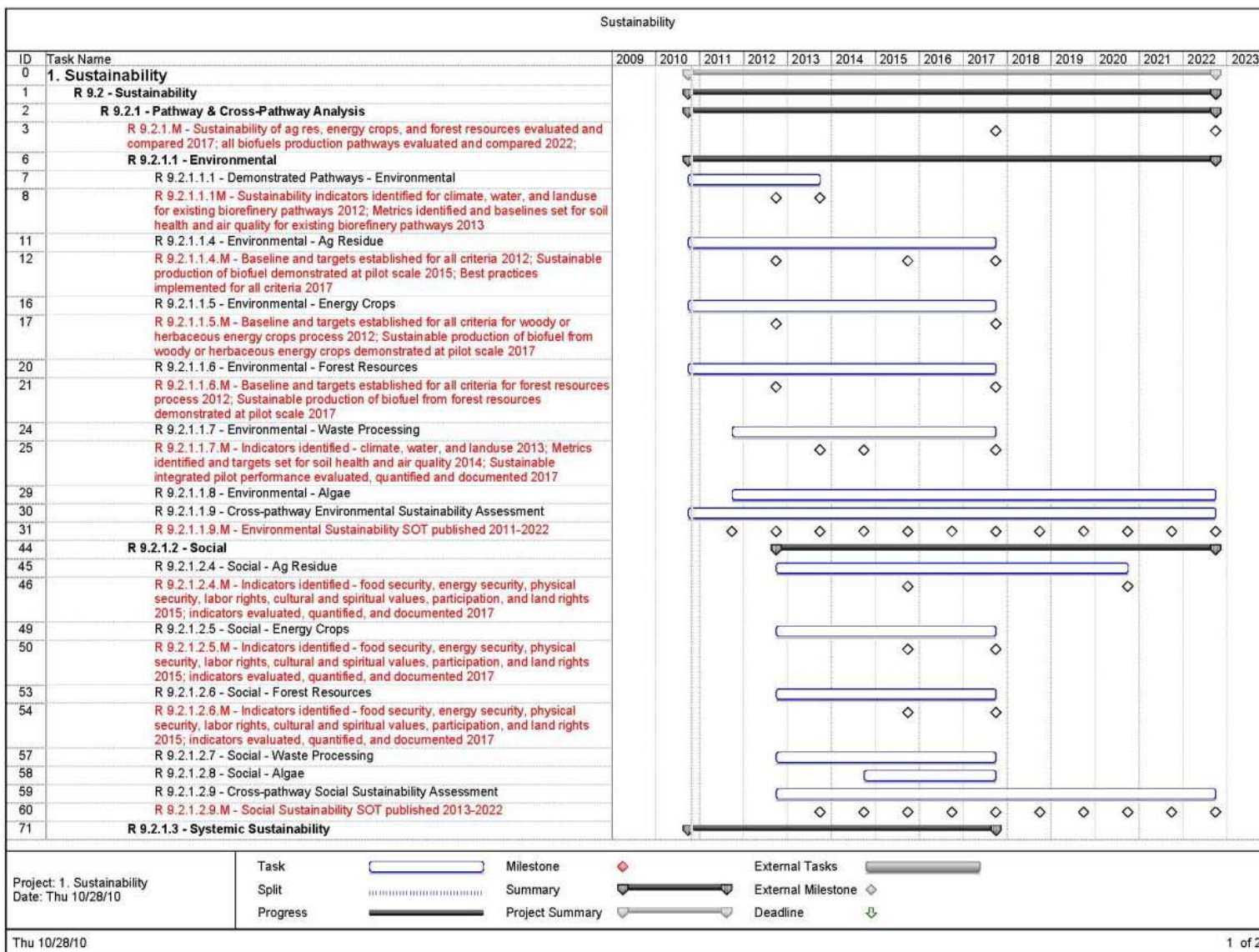

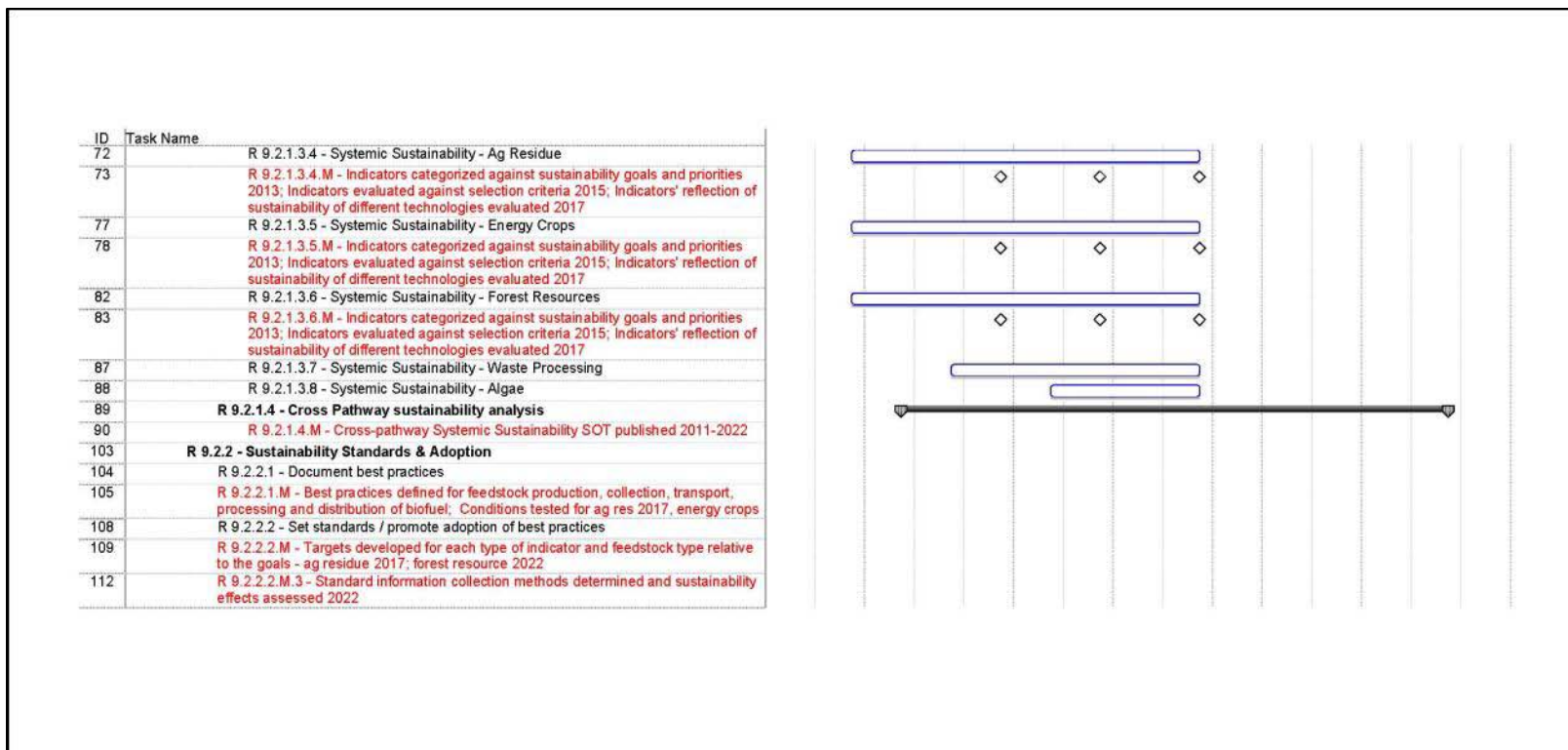

Project: 1. Sustainability Date: Thu 10/28/10	Task	Milestone	External Tasks
	Split	Summary	External Milestone
	Progress	Project Summary	Deadline
Thu 10/28/10			2 of 2

2.7 Strategic Analysis

Strategic analysis helps determine overall Program goals and priorities and covers issues that cut across all program elements. Analysis specific to technology area helps identify and understand questions around particular technology elements, contributes to engineering designs, and sets performance targets, as well as enables monitoring progress toward program goals. Benefits analysis tracks progress toward DOE and EERE goals, while technical analysis directs RDD&D projects.

Strategic Analysis plays four main roles in the Biomass Program decision-making process:

- 1) Providing the analytical basis for program planning and assessment of progress;
- 2) Defining and validating performance targets for biomass technologies and systems;
- 3) Reviewing and evaluating external analysis and studies; and
- 4) Contributing engineering analysis.

Maintaining these capabilities at the cutting edge is essential to ensure that the analysis provides the most efficient and complete answers to technology developers and program management. Continued public-private partnerships with the biomass scientific community and multi-lab coordination efforts will help ensure that the analysis results from the program are peer reviewed, transferable, and comparable.

Figure 2-38 shows how Strategic Analysis supports all elements of the biomass-to-bioenergy supply chain.

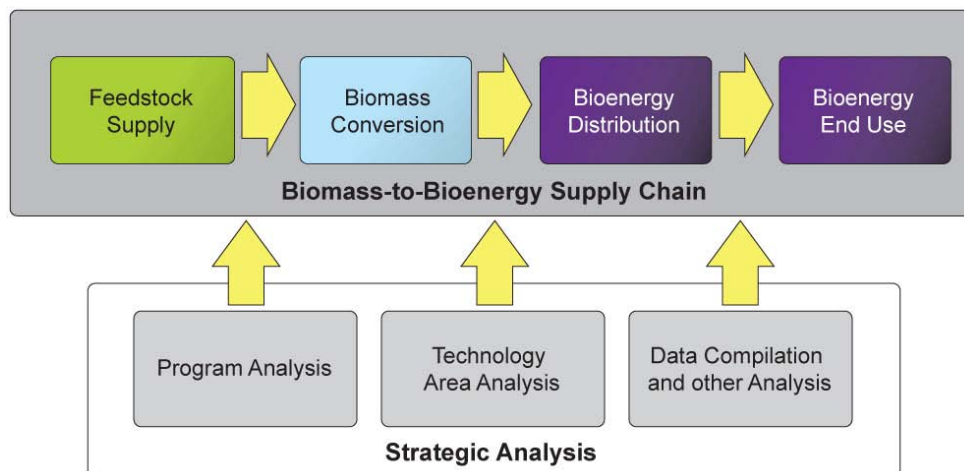

Figure 2-38: Strategic Analysis Supports the Entire Supply Chain

2.7.1 Strategic Analysis Support of Program Strategic Goals

Strategic Analysis' strategic goal is to *provide context and justification for decisions at all levels by establishing the basis of quantitative metrics, tracking progress toward goals, and informing portfolio planning and management.*

2.7.2 Strategic Analysis Support of Program Performance Goals

Strategic analysis activities support accomplishment of program goals by:

- Ensuring high quality, consistent, reproducible, peer-reviewed analysis
- Developing analytical tools, models, methods, and datasets to advance understanding of bioenergy and its related impacts
- Conveying the results of analytical activities to a wide audience including DOE management, Congress, the White House, and the general public.

Strategic analysis activities are ongoing, however, the following defines a key milestone in support of program goals:

- By 2012, understand the impacts of competition for biomass resources on feedstock cost, greenhouse gas emissions, and meeting EISA biofuels goals.

2.7.3 Strategic Analysis Challenges and Barriers

Several factors impact the ability to conduct the analysis needed to understand the implications and key factors for developing and sustainably deploying new biomass utilization technologies. These include the following key challenges and barriers:

At-A. Lack of comparable, transparent and reproducible analysis. Analysis results are strongly influenced by the datasets employed, as well as by the assumptions and guidelines established to frame the analysis. The lack of standardized datasets, assumptions, and guidelines makes results difficult to compare and integrate with the results of other analyses.

At-B. Limitations of analytical tools and capabilities for system-level analysis. Current analysis tools and models are not sufficient in their current state to enable understanding of broader bioenergy supply-chain-wide systems, linkages, and dependencies. Models need to be developed to understand these issues and their interactions. Improvements in component models and in linkages are necessary to make them more useful and consistent.

At-C. Inaccessibility and unavailability of data. To fully understand the biomass-to-bioenergy supply chain and its economic, environmental, and other impacts requires complete and comparable data. Current data are difficult to find, access, compile, and analyze. Some data that are required to understand all relevant dimensions of bioenergy production and use are unavailable or nonexistent.

2.7.4 Approach for Overcoming Challenges and Barriers

Strategic analysis activities are designed to support program decision-making processes and tracking program milestones. They validate decisions, ensure objective inputs, and respond to external recommendations. The work breakdown structure shown in Figure 3-39 shows the types of analysis activities undertaken by the Program. The descriptions below discuss the models and methods used for the various types of analysis being conducted for the Program by national laboratories, universities, and within EERE.

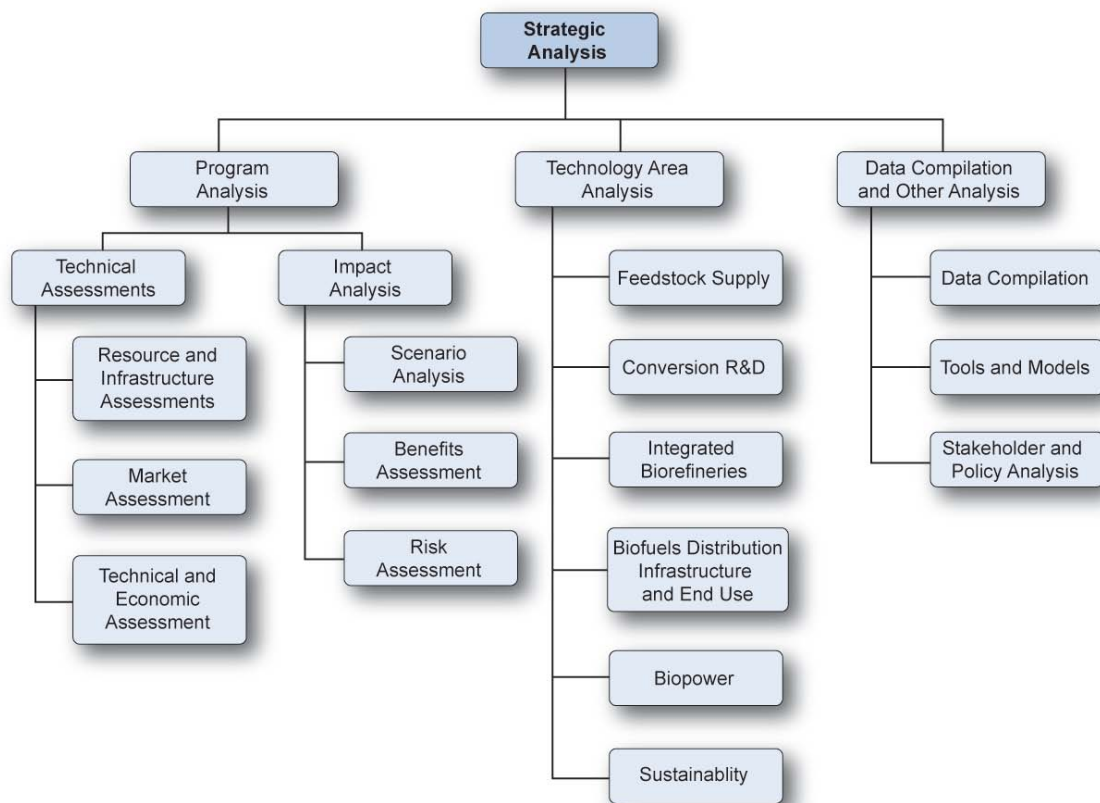

Figure 2-39: Strategic Analysis Work Breakdown Structure

Program Analysis

i) Technical Assessments

Resource and Infrastructure Assessments: Resource and infrastructure assessments are detailed below in Technology Area Analysis (under Feedstock Supply and Biofuels Distribution Infrastructure Analysis). Feedstock Supply resource assessments identify the geographic location, price, and environmental sustainability of accessing existing and potential future feedstock resource, as well as projecting future supply availability and prices. Strategic Analysis activities utilize these data to understand price effects of competition from various biomass utilization technologies (e.g., biofuel versus biopower), as well as to assess cross-technology impacts of feedstock cost, quantity, and quality.

Market Assessment: Market assessment helps the Program focus its technology development priorities in the near-, mid-, and long-term by analyzing the potential cost, commercialization time, and market demands for candidate biofuels, biopower, and bioproducts. This analysis draws on a broad range of other analyses including fossil fuel cost projections; future energy demand forecasts; infrastructure assessments; state of biomass utilization technology development; national and local sustainability analysis; and consumer, economic, and policy scenarios. This analysis also helps identify current and future market attractiveness, gaps, strengths, and risks that may impact producer, investor, and consumer decision-making.

Technical and Economic Assessment: The Program assesses the technical and economic viability of new processes and technologies, identifies potential for cost reduction, assesses cross-pathway and cross-technology progress, and provides input into portfolio development and technology validation. Near-term efforts focus on development of a model that uses pre-set assumptions combined with user-generated inputs to analyze and compare various biofuels conversion and production technologies by modeling minimum selling prices at specified rates of return. Technology and economic analysis methods and tools used include unit operation design flow and information models, process design and modeling (e.g., Aspen Plus^{©21}), capital costs (e.g., Aspen ICARUS²²) and operating cost²³ determination, discounted cash flow analysis, and Monte Carlo sensitivity analysis/risk assessment (e.g., Crystal Ball²⁴).

ii) Impact Analyses

Scenario Analysis: Understanding the impacts of changes and development of various elements of the biomass-to-bioenergy supply chain is key to informing technology portfolio planning and monitoring progress towards national goals. To help understand which supply chain modifications have the greatest potential to accelerate deployment of biofuels, the Program has supported development of the Biomass Scenario Model (BSM). The BSM is a systems dynamics model for conducting biofuels policy analysis through investigating the systemic effects, linkages, and dependencies across the biomass-to-biofuels supply chain. Figure 2-40 shows the conceptual structure of the model and an overview of the module for each supply chain component.

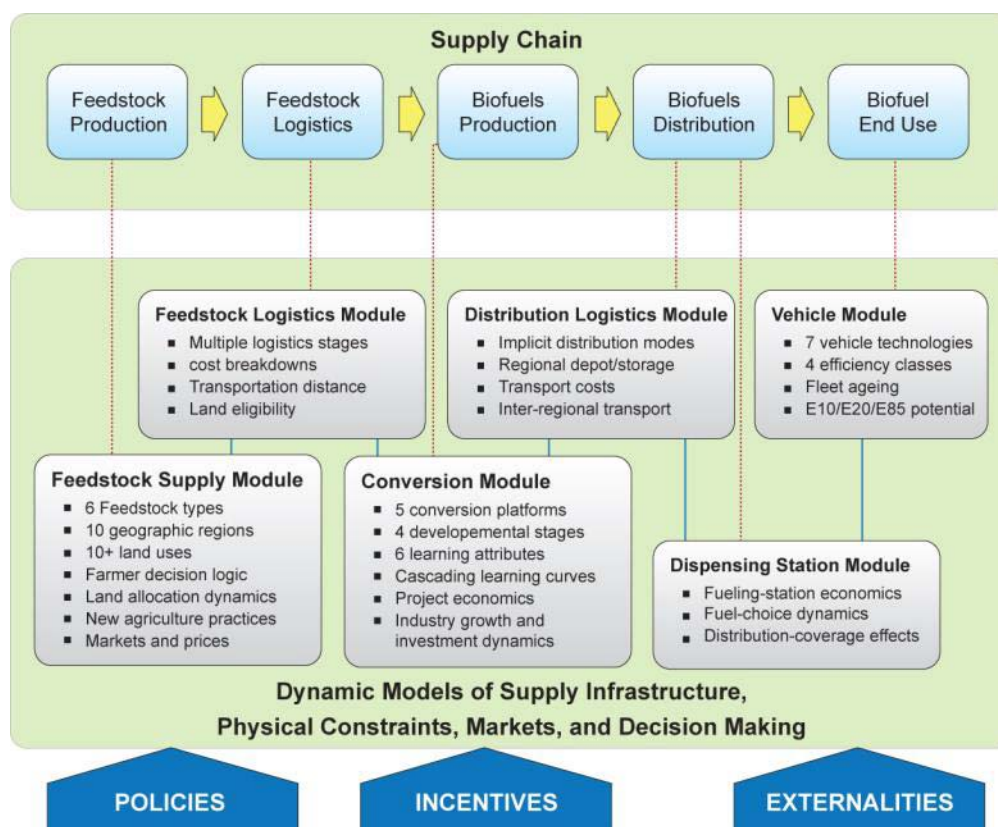

Figure 2-40: Conceptual Schematic of Biomass Scenario Model

Benefits Analysis: Benefits analysis helps the Program quantify and communicate the long-term benefits of biomass research, development, and deployment (e.g., imported oil displacement and greenhouse gas mitigation). The scenarios developed and the quantified costs and benefits are used to evaluate the most viable biomass utilization technologies and routes. Results are also used in crosscutting benefits analysis and are a key input to EERE renewable technology portfolio decision-making.

Using models such as National Energy Modeling System (NEMS) and Market Allocation (MARKAL) with Program inputs and assumptions, the EERE Office of Planning, Budget, and Analysis (PBA) projects 20 to 50 year economic, energy, and environmental outcomes of project success based on a business-as-usual scenario. PBA also coordinates the assessment of Government Performance and Results Act (GPRA)²⁵ benefits, which estimate some of the economic, environmental, and security benefits of achieving Program goals.

Risk Assessment: The major objective of risk assessment is to evaluate the technology development underway for biofuels, biopower, and bioproducts and combining that assessment with knowledge of industry deployment requirements and best practices to maintain focus on meeting the Program goals. This assessment includes all R&D efforts that DOE has sponsored and, to the extent possible, non-DOE efforts. Risk identification, quantification, and evaluation are used to assess progress, focus resources on critical efforts, identify gaps in technology development, and help manage risks. Clearly identifying critical path technologies and addressing potential showstoppers encourages greater private sector investment by increasing confidence in the likelihood of technical success. The systematic delineation of the risks in multiple pathways serves to identify key bottlenecks to commercial deployment and assists the Program in prioritizing investment among pathways.

Technology Area Analysis

Feedstock Supply R&D

Feedstock supply R&D analysis includes resource assessments and feedstock logistics system technical and economic assessments. Resource assessments estimate the current and future quantity and location of biomass resources by county, state, and region within the United States. Additionally, resource analysis projects resource cost as a function of the amount available on a sustainable basis for utilization.²⁶ A variety of integrated modeling tools (e.g., Policy Analysis System or POLYSYS²⁷) and databases are used to estimate sustainable feedstock supplies. Additionally, Geographical Information Systems (GIS) modeling tools are used to map and analyze resource data. Technical and economic analyses of feedstock logistics systems using the Integrated Biomass Supply Analysis and Logistics (IBSAL²⁸) model helps identify optimal methods for collection, transportation, and storage of biomass feedstocks.

Conversion R&D: Technical, economic, and environmental analyses of conversion technologies track research improvements and determine their contribution to reducing the cost of sustainably converting biomass feedstocks to fuels, power and products; identify areas of largest potential for cost reduction to guide R&D; and provide data to support deployment and transition analyses.

Integrated Biorefineries: The Program gathers technical and economic analyses from DOE-funded integrated biorefinery projects. These operations data from first-of-a-kind pilot-, demonstration-, and commercial-scale plants allow the Program to monitor progress against Program goals, compare projected benefits of various biomass utilization technologies, and assess the current state-of-technology development. Integrated biorefinery projects also provide critical insights into the challenges associated with building first-of-a-kind plants.

Distribution Infrastructure and End Use: This analysis includes an assessment of current and future distribution infrastructure capacity and dispensing system constraints. It helps identify, evaluate, and sequence strategies for addressing distribution infrastructure and end use issues. This analysis includes assessments of the U.S. liquid transportation fuel distribution network, the characteristics and expected changes in national vehicle fleet, and the implications for acceptance of alternative fuels.²⁹

Biopower: Technical, economic, and environmental analyses of biopower technology options will help inform technology priorities, focus R&D, help establish baselines and goals, and monitor progress.

Sustainability: Strategic Analysis supports program sustainability efforts through developing and maintaining computer models to quantify the environmental impacts of biomass production and utilization technologies, for example, life cycle analysis (LCA), and land-use change (LUC). This analysis is discussed in detail under [Section 2.6](#), Sustainability. It is heavily reliant upon the development of practical, scientifically based, verifiable, cost-effective indicators, metrics, and baselines, as outlined in that section.

LCA models identify and evaluate the emissions, resource consumption, and energy use of various processes, technologies, or systems^{30,31,32,33,34,35} to help understand the full impacts of existing and developing technologies and prioritize efforts to mitigate negative effects. The Greenhouse Gases, Regulated Emissions, and Energy Use in Transportation³⁶ (GREET) model is used to estimate fuel-cycle energy use and emissions associated with alternative transportation fuels and advanced vehicle technologies.

The Global Trade Analysis Project (GTAP) model at Purdue University is being modified to more accurately reflect the direct and indirect effects of land use change from the biofuels industry in the U.S. Additional models and analyses will be needed to better understand the multiple—and often multidirectional—drivers of land use change.

Extensive analysis is being conducted to address water quantity and quality issues related to feedstock growth and biofuels production, using the SWAT (Soil and Water Analysis Tool) model.

Data Compilation and Other Analysis

Data Compilation: Many disciplines and sectors are involved in bioenergy RDD&D. Developing, compiling, maintaining, and providing easy access to the best available, credible data, models, and visualization tools is critical to supporting sustainable commercialization of

biomass utilization technologies. To serve this need, the Program is developing The Knowledge Discovery Framework (KDF), a Web-based data repository, visualization tool, and library. The goal of the KDF is to facilitate planning, development and management decisions by providing a means to synthesize, analyze, and visualize vast amounts of information in a relevant and succinct manner. KDF's GIS-based data analysis, mapping, and visualization components draw from dynamic and disparate databases of information to enable users to analyze economic, social, and environmental impacts of various biomass utilization technologies for biomass feedstocks, biorefineries, and infrastructure.

Tools and Methods: The Program supports the development and deployment of new analytical tools and methods and guides the selection of assumptions and methodologies to be used for all analyses to ensure consistency, transparency, and comparability of results.

Stakeholder and Policy Analysis: The Program provides ongoing analysis and policy support to other U.S. government agencies and legislative bodies. Emerging issues, interests, and trends raise new questions from a wide variety of stakeholders, including DOE senior management, members of Congress, other federal agencies, and state governments. Scholarly articles, popular media, and other broader forums are additional sources of questions for analysis.

Table 2-14. Strategic Analysis Activity Summary

Goal: Provide context and justification for decisions at all levels by establishing the basis of quantitative metrics, tracking progress toward goals, and informing portfolio planning and management				
WBS Element	Description	FY10 Performer	Barriers Addressed	
Program Analysis				
Technical Assessments				
Resource and Infrastructure Assessments	Assess implications of resource constraints and availability, and distribution system capacity and constraints given timing and volumes of mandated biofuel and biopower production	ORNL	<ul style="list-style-type: none"> • At-A: Lack of comparable, transparent and reproducible analysis • At-B: Limitations of analytical tools and capabilities for system level analysis • At-C: Inaccessibility and unavailability of data. 	
Market Assessment	Determine the cost, timing, and market demands for candidate biofuels and biocrudes	NREL		
Technical and Economic Feasibility Assessment	<ul style="list-style-type: none"> - Comparative technical and economic assessment of biofuels - Support of the Comprehensive Integration of Annual SOT Assessment - Support feedstock-pathway-wide techno-economic analysis 	NREL, ORNL, INL, PNNL		
Impact Analysis				
Environmental Sustainability Analysis	Develop and maintain models used to assess Land Use, GHG and Lifecycle impacts and support overall program sustainability analysis	ANL, Purdue University, ORNL, NREL		
Scenario Analysis	Assess impacts of changes and development of various elements of the biomass-to-bioenergy supply chain and identify impacts of supply chain modifications on deployment of biofuels	NREL SI		
Benefits Assessment	Evaluate and document impact of biofuels on U.S. economies and environment	PBA, NREL SI		
Risk Analysis	Identify, quantify, and evaluate uncertainty and risk of biofuels. Includes SEDS for assessing technical, economic, and financial risks	NREL SI		
Technology Area Analysis				
Feedstock Supply	<ul style="list-style-type: none"> - Assess quantity and associated costs of biomass resources - Develop feedstock logistics process design and monitor SOT progress towards targets 	ORNL, INL		
Conversion R&D	Develop techno-economic process designs, monitor state-of-technology development and progress toward targets	NREL, PNNL		
Integrated Biorefineries	<ul style="list-style-type: none"> Technical and economic analysis of integrated biorefinery projects - Compile operations data from pilot-, demonstration-, and commercial-scale plants - Assess the current state-of-technology development 	* See Section 2.3 , Integrated Biorefineries		
Distribution Infrastructure and End Use	Assess distribution infrastructure capacity based on projected timing for mandated volumes of cellulosic ethanol and other advanced biofuels entering the market	NREL, ORNL		
Biopower	Analysis of biopower technology options, development of design reports, and SOT tracking	TBD		
Data Compilation and Other				
Data Compilation	Biomass energy data book, available on Web; Develop Knowledge Discovery Framework	ORNL		
Tools and Methods	<ul style="list-style-type: none"> Develop new analytical tools and methods as needed to address emerging needs - Establish and maintain standardized assumptions and methods 	DOE		
Stakeholder, Policy, and International Analysis	<ul style="list-style-type: none"> - Evaluate and document impact/implications of U.S. biofuels legislation (Farm Bill, EPACT, EISA) - Conduct specified analyses to provide technical support to GFO (proposal evaluation), EPA, USDA, CARB, and other agencies 	ANL, ORNL, NREL		

2.8 Bioenergy Market Expansion

Bioenergy market expansion through the increased production and use of biofuels, biopower, and bioproducts will require fundamental changes in our economy over the next decade. Achieving program goals will require significant changes across multiple sectors and industries.

Agriculture, forestry, waste management, and transportation fuels industries will need to efficiently supply the required feedstocks for sustainable bioenergy production. Local, regional, and national markets will need to adapt and expand. The use of new feedstocks, along with the scale and cost of production of these technologies, will fundamentally alter relationships among growers, producers, technology developers and providers, financiers, and end users. Our nation's transportation sector, including its fueling infrastructure and automotive fleet, will need to evolve to accommodate the growing use of alternative fuels.*

Bioenergy market expansion is focused on identifying and addressing non-technical and market barriers to bioenergy adoption and use to reach full-scale market penetration. In addition to the wide range of RDD&D technical activities, the Program facilitates greater market penetration by enabling industries and sectors to transition to a robust bioenergy economy, while adequately factoring in the conflicting interests of its many stakeholders. These activities are geared toward fostering greater awareness and acceptance of significantly increased production of sustainable biofuels, biopower, and bioproducts needed to realize the benefits and opportunities of a robust bioenergy economy. Accordingly, the Program promotes meaningful collaborations with a range of stakeholders, supports appropriate government policy and regulation, and uses strategic communication to increase consumer acceptance and accelerate the expansion of bioenergy production and use. The diagram in Figure 2-41 outlines the Bioenergy Market Expansion activities that support all elements of the biomass-to-bioenergy supply chain.

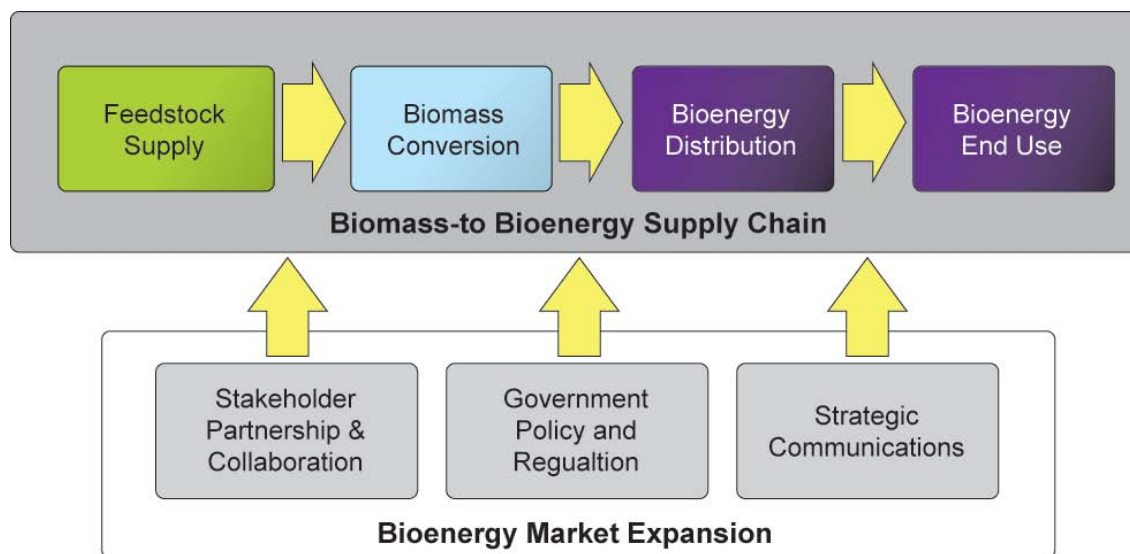

Figure 2-41: Market Expansion Activities Influence All Supply Chain Elements

*The EIA's 2010 projections through 2035 indicate that biofuels will account for nearly all the growth in liquid fuel consumption in the United States over the next 25 years—primarily in the transportation sector, where almost all liquid fuels are consumed. See *Annual Energy Outlook, 2010* at <http://www.eia.doe.gov/oiaf/aeo/>.

Stakeholder Partnerships and Collaborations. The Program works closely with industry stakeholders and project partners, groups, and associations, as well as with national laboratories, academic institutions, non-profit organizations, and state, regional, and international research institutions and organizations to facilitate market expansion. Key components of the Program's work are coordinated or conducted with other federal agencies including DOD, DOI, DOT, EPA, NSF, NASA, and USDA* through joint solicitations, the Biomass Research and Development Board, and other mechanisms.

Government Policy and Regulation. The Program provides support to policy-makers who are implementing financial incentives, legislative mandates, and other mechanisms to accelerate bioenergy market expansion. The Program also works with international, federal, and state regulators and codes and standards organizations to develop, modify, and harmonize regulations and standards that will facilitate a new bioenergy industry.

Strategic Communications. Strategic communications efforts include technical and non-technical communication to all external stakeholders through various media including written, electronic/social, as well as external presentations. In addition to conveying key Program goals, priorities, activities, and accomplishments, strategic communications also focuses on creating and maintaining public awareness and promotion of bioenergy production and use to a range of audiences.

2.8.1 Bioenergy Market Expansion Support of Program Strategic Goals

Bioenergy Market Expansion supports the Program's strategic goal by conducting activities to accelerate the multi-industry transformation that is necessary to expand the domestic bioenergy industry, thus helping to meet EISA and other national goals.

2.8.2 Bioenergy Market Expansion Support of Program Performance Goals

The performance goals for the Program's Bioenergy Market Expansion activities are:

- Streamline and increase the effectiveness of critical stakeholder partnerships to facilitate sharing of best practices and improve understanding and advancement of the state of technology to accelerate industry growth.
- Support more efficient and effective coordination among policy, regulatory, permitting, and standards organizations.
- Solidify a positive public perception of bioenergy – specifically biofuels – by better informing stakeholders and the public about the investments necessary to achieve national goals, Program results and accomplishments, environmental benefits, and progress toward national goals.

* DOD – Department of Defense; DOI – Department of the Interior; DOT – Department of Transportation; EPA – Environmental Protection Agency; NSF – National Science Foundation; NASA – National Aeronautics and Space Administration; USDA – United States Department of Agriculture.

2.8.3 Bioenergy Market Expansion Challenges and Barriers

Accelerating the growing bioenergy economy will require addressing market barriers at local, state, and federal levels. Bioenergy Market Expansion activities are focused at addressing the following market challenges and barriers:

Mm-A. Level of Industry and Consumer Acceptance and Awareness: To be successful in the marketplace, biomass-derived fuels and chemical products must perform as well or better than comparable petroleum- and fossil-based products. Industry partners and consumers must believe in the quality, value, sustainability, and safety of biomass-derived products and their benefits relative to the risks and uncertainties that widespread changes will likely bring. Compared to other renewable technologies, consumer acceptance and awareness of biofuels and bioenergy technologies are varied. Impartial, reliable information regarding the economic and environmental benefits and impacts of increased bioenergy use is not always widely available.

Mm-B. Inconsistent or Competing Policies and Drivers to Facilitate Multi-Sector Shifts: Expanding biofuels production to meet federal goals will require managing and responding to different market and policy drivers and considerable federal, state, and local investments. Proper alignment and careful choice of policy tools across several different sectors is crucial. Legislation may ultimately determine the future portfolio mix for bioenergy production and use.

Mm-C. Insufficient or Inconsistent Regulations and Standards. Certain local, state, and federal regulations are not yet fully developed or are inconsistent with existing regulations, which constrains the development of the bioenergy industry. Long lead times associated with developing and implementing new and revised regulations for technology can delay or stifle commercialization and deployment. In addition, several organizations are in the process of developing voluntary certification schemes and standards processes for sustainable bioenergy; however, their implementation timeframes may align well with new technology commercialization and deployment timelines.

2.8.4 Approach for Overcoming Bioenergy Market Expansion Challenges and Barriers

The approach for overcoming Bioenergy Market Expansion challenges and barriers is outlined in the diagram shown in Figure 2-42 and described below.

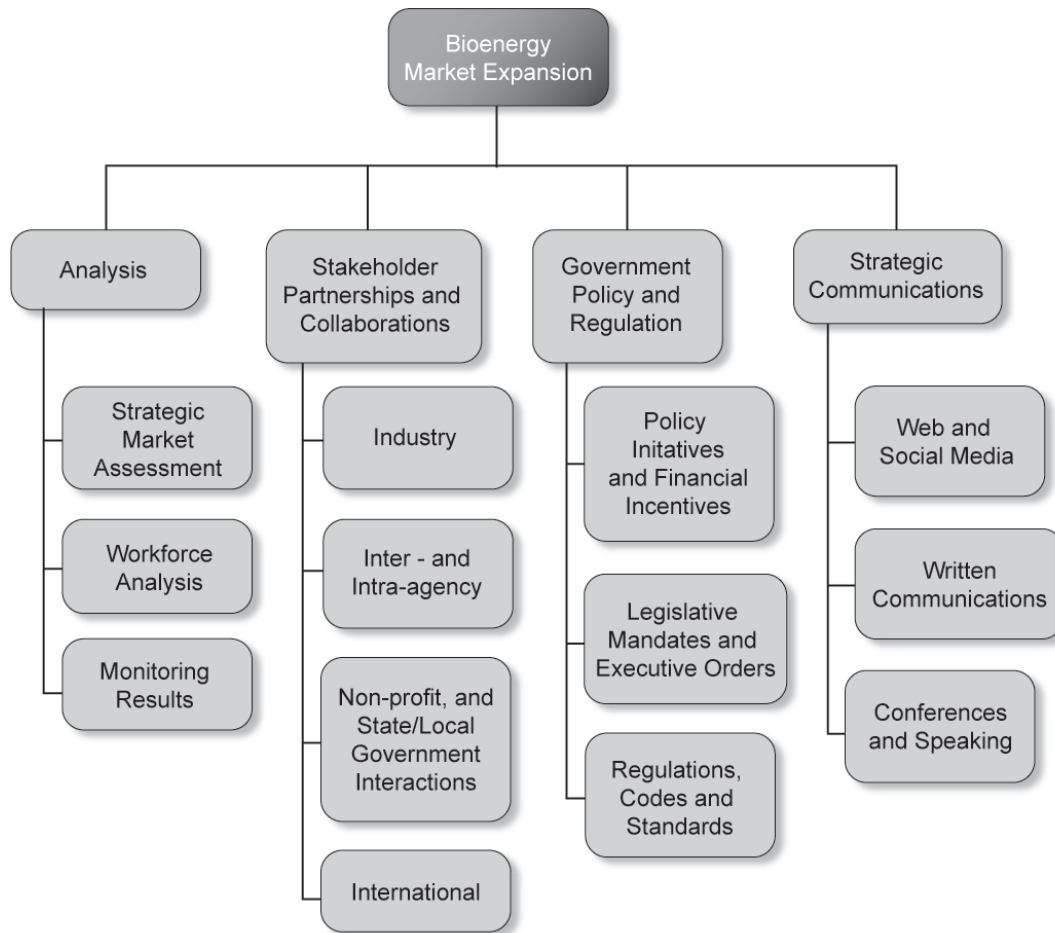

Figure 2-42: Bioenergy Market Expansion Work Breakdown Structure

Analysis

Near-term activities include crosscutting market and information analyses to measure public perceptions. These activities will also include a strategic assessment of existing and near-term national workforce needs. Longer-term efforts will include measuring and monitoring the impact of Bioenergy Market Expansion activities for developing additional targeted efforts.

Stakeholder Partnerships and Collaborations

Key ongoing and near-term activities include collaboration with industry stakeholders as research and development partners in all technical areas; these activities are described more fully in other sections of the MYPP. DOE also works with trade organizations and other industry groups in specific technical areas to ensure the Program supports industry needs and utilizes industry experts to provide guidance and feedback in its review processes.

Program activities also include maintaining and enhancing formal and informal interagency coordination and collaboration on mutually agreed high-priority activities. Across DOE, this primarily includes working with other EERE programs including Vehicle Technologies, Federal Energy Management, and Industrial Technologies Programs as well as the Office of Science and

the Advanced Research Projects Agency-Energy. Outside DOE, this includes providing leadership, proactive participation, or support to many interagency and public/private activities, including the Biomass Research and Development Board, the Technical Advisory Committee, the Commercial Aviation Advanced Fuels Initiative, and the International Standards Organization, as well as maintaining ongoing collaborations in specific technology areas.

Near-term Program activities will also focus on greater technical and regulatory outreach involving state and local entities, non-profits, industry associations, international partners, and other key stakeholders. For example, collaborations with multi-stakeholder groups focused on environmental impacts and benefits, such as the Roundtable on Sustainable Biofuels, help ensure Program technical expertise is being incorporated into fora where it provides value. Mid- to longer-term efforts include maintaining or expanding outreach and partnering efforts in designing and implementing select bioenergy market expansion activities.

Government Policies and Regulation

Ongoing activities include providing analysis and technical expertise to inform DOE decision-makers and motivate the effective alignment and implementation of federal policies. Near-term activities include supporting the Biofuels Interagency Working Group (BIWG) to coordinate efforts, help identify appropriate policy options, and project the impacts of policies and programs, such as USDA's Biomass Crop Assistance Program on bioenergy market penetration. Near- and longer-term activities include working with domestic and international regulatory agencies to harmonize regulations, codes, and standards that apply to biomass-based technologies and systems.

Strategic Communications

Near-term efforts include development of strategic communications plan focused on better engaging the public to deepen understanding of the environmental, economic, social, and energy security benefits of biofuels, biopower, and bioproducts, as well as to calibrate expectations for near- and medium- term RD&D achievements. This includes use of a broader array of education and engagement techniques and more effective utilization of electronic and social media to address negative perceptions about bioenergy and draw attention to positive perceptions, results, and accomplishments. Near- to long-term efforts focus on strengthening the Program's use of written, electronic, and social media and its presence at key conferences.

Activities for each of these areas are outlined in Table 2-15.

Table 2-15. Bioenergy Market Expansion Activity Summary

Goal: Support the Program’s strategic goal by conducting activities to accelerate the expansion of the domestic bioenergy industry to meet EISA and other national goals.			
Element	Description	FY 10 Performer	Barriers Addressed
Analysis	<ul style="list-style-type: none"> Strategic Market Assessment of public awareness, perception, and support of renewable fuels industry to determine key non-technical drivers/opportunity points. Monitoring and Reporting on deployment, commercialization, and other technology results; accomplishments and positive economic indicators such as jobs, local tax revenue increases; and other key factors associated with economic, social, and environmental benefits. Workforce Analysis to determine existing status, identify gaps, and develop recommendations for curriculum development and career tracks. 	DOE Other TBD	<ul style="list-style-type: none"> Mm-A: Level of Industry and Consumer Acceptance and Awareness Mm-B: Inconsistent or Competing Policies and Drivers to Facilitate Multi-Sector Shifts
Stakeholder Partnerships and Collaborations	<ul style="list-style-type: none"> Industry Partnerships to accomplish R&D goals and strategic relationships with trade groups and other industry organizations to help expedite implementation. Non-profit, State/Local Government, and Associations: Facilitate increased interaction, consistent information exchange, and targeted activities with a range of partners. Identify and implement innovative means to partner and develop best practices, such as cooperative agreements. Federal Coordination and Collaboration: Co-lead Biomass Research and Development Board; participate in interagency RD&D activities, analyses, and other efforts; coordinate bioenergy planning and interface activities with other EERE programs and DOE offices. International: Foster cooperation and information exchange among biomass experts on areas such as sustainability, and with the International Energy Agency, the Global Bioenergy Partnership, and other international organizations. 	DOE	<ul style="list-style-type: none"> Mm-A: Level of Industry and Consumer Acceptance and Awareness Mm-B: Inconsistent or Competing Policies and Drivers to Facilitate Multi-Sector Shifts Mm-C: Insufficient or Inconsistent Regulatory Standards
Government Policy and Regulation	<ul style="list-style-type: none"> Policy Initiatives and Financial Incentives: Support alignment and effective execution of initiatives and incentives, e.g. the Biomass Crop Assistance Program and loan guarantee programs, through high-level efforts such as the Biofuels Interagency Working Group. Legislative Mandates and Executive Orders: Support biomass-related legislative mandates and executive orders. Regulations, Codes and Standards: Work with domestic and international regulation, codes and standards organizations (e.g. ANSI/ISO, EPA, USDA, NIST, ASTM, UL*) to harmonize requirements. 	DOE	<ul style="list-style-type: none"> Mm-A: Level of Industry and Consumer Acceptance and Awareness Mm-B: Inconsistent or Competing Policies and Drivers to Facilitate Multi-Sector Shifts Mm-C: Insufficient or Inconsistent Regulatory Standards
Strategic Communications	<ul style="list-style-type: none"> Web and Social Media: Increase public acceptance and build support and consumer commitment to bioenergy using internet-based and new media tools; better showcase successful demonstrations of first-of-a-kind technologies. Written Communications: Enhance range of written Program communications (e.g. technical and project-specific information) and their dissemination. Conferences and External Speaking: Strategic conference attendance and speaking events. 	DOE Other TBD	<ul style="list-style-type: none"> Mm-A: Level of Industry and Consumer Acceptance and Awareness

* ANSI/ISO - American National Standards Institute/ International Organization for Standardization; NIST – U.S. National Institute of Standards and Technology; ASTM International – An international standards organization; UL - Underwriters Laboratories, an independent product safety certification organization

Endnotes

- ¹ Hess, J.R.; Cushman, J.H.; Easterly, J.L.; Erbach, D.C.; Foust, T.D.; Graham, R.; Hettenhaus, J.R.; Hoskinson, R.L.; Perlack, R.D.; Sheehan, J.J.; Sokhansanj, S.; Tagore, S.; Thompson, D.N.; Turhollow, A.; Wright, L.L. (2003). Roadmap for Agricultural Biomass Feedstock Supply in the United States. DOE/NE-ID-11129 Rev 1. Idaho Falls, ID: Idaho National Laboratory. <http://www.inl.gov/technicalpublications/Documents/3323197.pdf>
- ² Hess JR, KL Kenney, LP Ovard, EM Searcy, CT Wright (2009) Uniform-format solid feedstock supply system: a commodity-scale design to produce an infrastructure-compatible bulk solid from lignocellulosic biomass. INL/EXT-08-14752 www.inl.gov/bioenergy/uniform-feedstock.
- ³ Searcy, E.M., J.J. Jacobson, and C.T. Wright. 2010. 2010 Dry Herbaceous Biomass State-of-Technology (SOT) Costs. Idaho National Laboratory Technical Memorandum, TM2010-001-0.
- ⁴ INL Feedstock Model v2-12-07ctw
- ⁵ Lignocellulosic Biomass to Ethanol Process Design and Economics Utilizing Co-Current Dilute Acid Prehydrolysis and Enzymatic Hydrolysis for Corn Stover,” NREL TP-510-32438, June 2002.
- ⁶ “Breaking the Biological Barriers to Cellulosic Ethanol: A Joint Research Agenda,” DOE/SC-0095, June 2006.
- ⁷ Biochemical Production of Ethanol from Corn Stover: 2008 State of Technology Model, Dave Humbird, Andy Aden, February 2009. (*Note: Unit operation cost contribution estimates are based on process concept targets; For “Processing Total,” please see footnote on Table B4 in Appendix B for comments on rounding of numbers and subsequent summation*)
- ⁸ “Lignocellulosic Biomass to Ethanol Process Design and Economics Utilizing Co-Current Dilute Acid Prehydrolysis and Enzymatic Hydrolysis for Corn Stover,” NREL/TP-510-32438, 2002.
- ⁹ “Thermochemical Ethanol via Indirect Gasification and Mixed Alcohol Synthesis of Lignocellulosic Biomass,” NREL/TP-510-41168, April 2007.
- ¹⁰ Production of Gasoline and Diesel from Biomass Via Fast Pyrolysis, Hydrotreating and Hydrocracking: A Design Case,” PNNL-18284, February 2009.
- ¹¹ U.S. Energy Information Administration, Biofuels in the U.S. Transportation Sector, Table 11, <http://www.eia.doe.gov/oiaf/analysispaper/biomass.html>.
- ¹² EIA Annual Energy Outlook 2009, Updated Reference Case with ARRA, Table 112. Components of Selected Petroleum Product Prices. http://www.eia.doe.gov/oiaf/aeo/supplement/stimulus/arra/excel/sup_ogc.xls
- ¹³ EIA Annual Energy Outlook 2009, Updated Reference Case with ARRA, Table 11. Liquid Fuels Supply and Disposition. http://www.eia.doe.gov/oiaf/servicerpt/stimulus/excel/aeostimtab_11.xls
- ¹⁴ U.S. DOE EIA; Electric Power Annual 2008; Table ES1. Summary Statistics for the United States. Available at: <http://www.eia.doe.gov/cneaf/electricity/epa/epaxlfiles1.pdf>
- ¹⁵ European Bioenergy Networks (EUBIONET); “Biomass Co-Firing – An Efficient Way to Reduce Greenhouse Gas Emissions”. Available at: http://ec.europa.eu/energy/renewables/studies/doc/bioenergy/2003_cofiring_eu_bionet.pdf
- ¹⁶ National Renewable Energy Laboratory (Report NREL/SR-570-26946); Lessons Learned - from Existing Biomass Power Plants February 2000. Available at: <http://www.nrel.gov/docs/fy00osti/26946.pdf>
- ¹⁷ National Renewable Energy Laboratory (Conference Paper); Biomass Power Systems. EPRI Conference on New Power Generation Technology, 10/1995, San Francisco, CA. Available at: <http://www.p2pays.org/ref/19/18949.pdf>

Section 3: Program Portfolio Management

This section describes how the Biomass Program develops and manages its portfolio of RDD&D activities. It identifies and relates different types of portfolio management activities, including portfolio decision making, analysis, and performance assessment.

Overview

The Biomass Program manages a diverse portfolio of technologies across the spectrum of applied research, development, demonstration, and deployment (RDD&D). Management of the Program's technology portfolio is a vital and demanding activity, made even more challenging by the fact that management of the portfolio necessarily must occur within the dynamic context of changing federal budgets and evolving administrative priorities.

To meet this challenge, the Program has developed a coordinated framework for managing its portfolio of RDD&D projects. The framework is based on systematically investigating, evaluating, and down-selecting the most promising opportunities across a diverse spectrum of emerging technologies and technology readiness levels (TRLs). This approach is intended to support a diverse technological base in applied research and development while identifying the most promising targets for follow-on industrial scale demonstration and deployment. The RDD&D pipeline is shown diagrammatically in Figure 3-1.

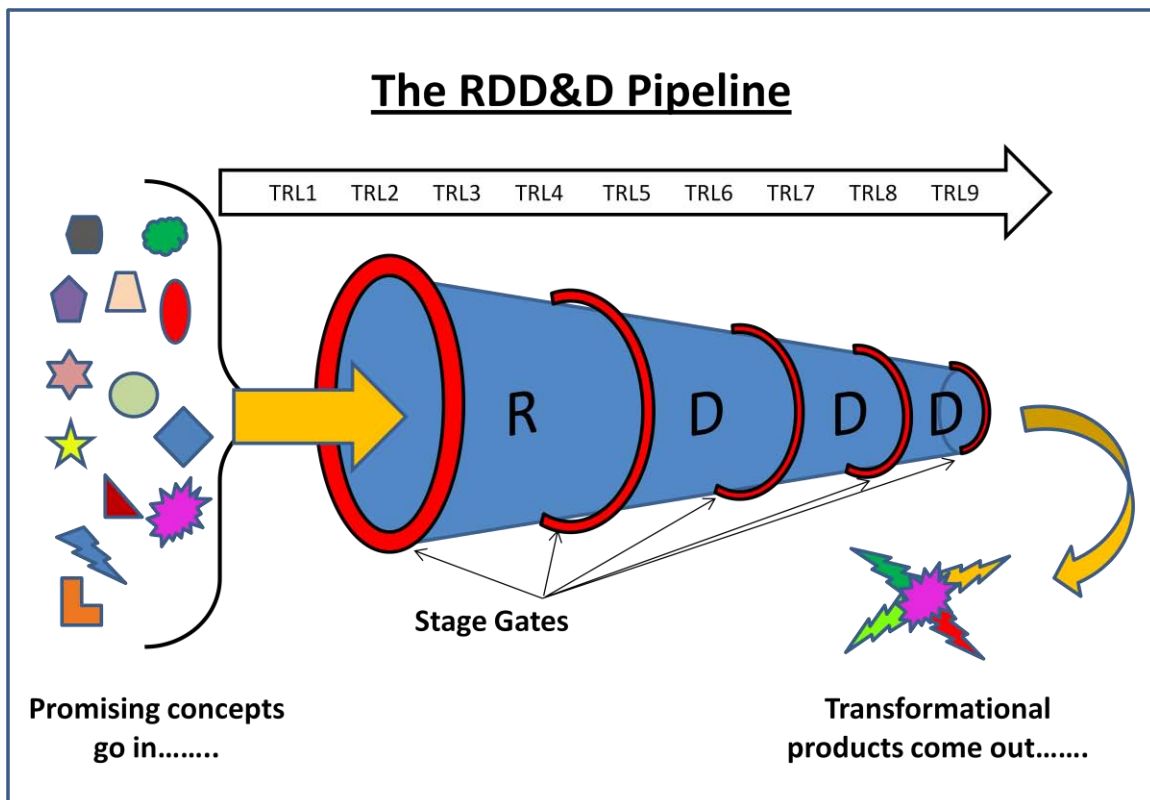

Figure 3-1: The RDD&D Pipeline

This approach has several distinct advantages:

- It assures the Program will examine diverse feedstocks and conversion technologies for producing biofuels, biopower, and bioproducts.
- It effectively links resources with the stages of technology readiness, from applied research through commercial deployment.
- It successfully identifies gaps within the portfolio, as well as crucial linkages between the stages of RDD&D.
- It is adequately flexible to accommodate new ideas and approaches as well as various combinations of feedstock and process in real biorefineries.
- It incorporates a stage-gate process, which guarantees a series of periodical technology readiness reviews to help inform the down-selection process.

3.1 Program Portfolio Management Process

The Biomass Program manages its portfolio based on the approach recommended under the EERE Program Management Initiative,¹ complemented with processes derived from classical systems engineering for managing technically complex programs. The five major steps in the Program portfolio management process are shown in Figure 3-2 and described on the following pages.

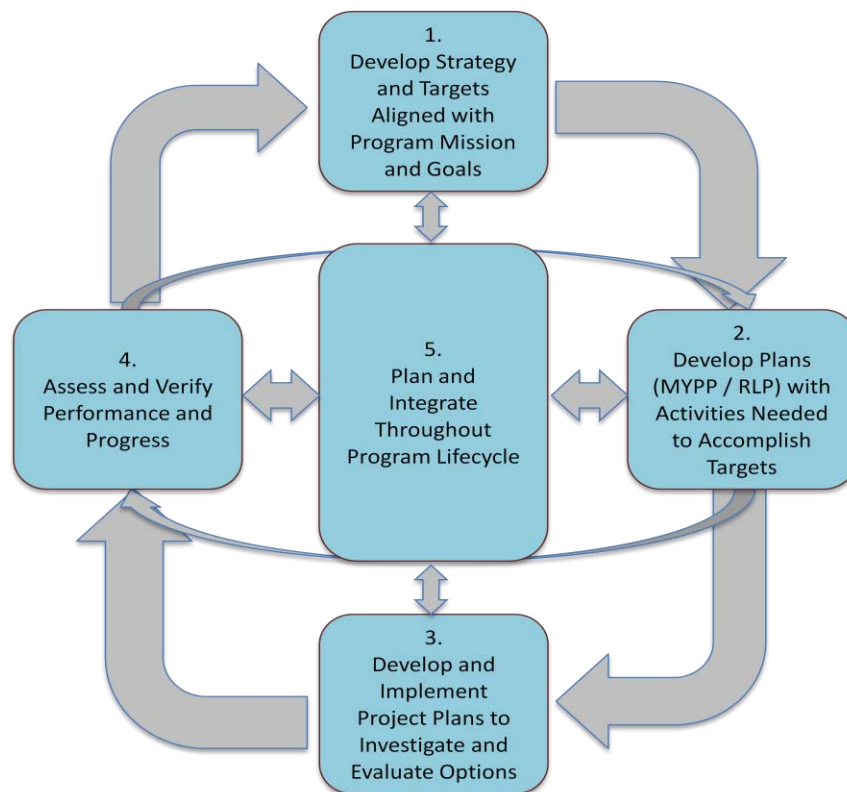

Figure 3-2: Program Portfolio Management Process

Step 1: Develop Program Strategy and Targets Aligned with Program Mission and Goals.

Step 1 encompasses the process of developing the Program mission and goals (outlined in Section 1), both of which are developed from a combination of the Program's strategic goal hierarchy (Figure 1-5) based on national goals, administrative and legislative priorities, and DOE and EERE strategic goals and priorities, in alignment with the goals of other federal agencies.

The Program design and logic (Figure 1-7) detail how the mission and goals fit within the planning and budgetary framework of the Program. Combining the Program design and logic with an understanding of market needs and technical scenarios leads to the definition of Program targets that are consistent with government objectives. Targets are allocated to the Program elements responsible for managing and funding research related to the targets.

Portfolio decision making at the strategic level is based on three main criteria:

- Does the portfolio contain the correct elements across the RDD&D spectrum of activities to meet the technical and/or market targets required to achieve Program goals?
- Does the portfolio sponsor diverse technologies that can buy down the risk of producing competitively priced bioenergy?
- Does the portfolio support the establishment of the bioenergy industry in the United States?

Step 2: Develop Plans (MYPP / RLP) with Activities Needed to Accomplish Targets.

Step 2 guides how the Program develops its Multiyear Plan to outline the path to achieving the high-level Program technical and market targets defined in Step 1.

Each Program technical area has performance goals and barriers identified through internal evaluation and public-private collaborative meetings. To meet the programmatic performance goals and address the associated barriers, each technical area develops a multiyear Resource Loaded Plan (RLP) that identifies the strategic activities and associated resources to achieve respective targets. Programmatic priorities to address the barriers are determined by balancing the needs and driving forces behind the emerging industry within the context of inherently governmental activities.

The RLPs for each platform are then integrated into a Program-wide plan and evaluated for gaps and linkages. Gaps that are identified are addressed, while linkages between the platforms are highlighted so that all parts of the supply chain are developed iteratively to comparable levels of maturity over time. The RLPs form the basis for activities described in the Multiyear Program Plan (MYPP). The MYPP is designed to undergo review and be updated on a regular basis to incorporate technology advances, Program learning, and changes in direction and priority.

Step 3: Develop and Implement Project Plans to Investigate and Evaluate Options.

Step 3 involves developing individual project management plans (PMPs) that are aligned with the MYPP and the platform RLPs. The PMPs define the work selected to investigate and

evaluate the chosen approaches for achieving the Program level technical and market targets, as well as milestones in the MYPP.

Project development and analysis are used to define a portfolio of projects that, when combined, will most effectively achieve Program targets. Factors considered at the project level are similar to those considered at the Program level in Step 2 and include potential benefits, scope, cost, schedule, and risk. Also, like Step 2, this is an iterative process that weighs benefits against costs and risks; however the emphasis stays on the specific projects under consideration and how they compare to each other, as well as their relevance to the Program. At the initiation of a project, a PMP is prepared to describe the entire project duration, with special attention to the activities planned for the year. PMPs are updated annually based on actual progress, results of interim stage-gate reviews, and updates to the Program MYPP.

Step 4: Assess and Verify Performance and Progress.

Step 4 involves a system of performance assessments held on multiple levels to monitor and evaluate performance and progress as the Program is implemented (described in detail in section 3.2). The Project Management Center (PMC) evaluates project performance on a quarterly basis against baseline schedule, scope, and cost provided in the PMP. The Program's subprogram element peer reviews and an overall Program peer review are conducted biennially to provide decision making on future funding and direction. Stage-gate reviews are conducted at the individual project level to assess technical, economic, environmental, and market potential, as well as risk.

In large-scale demonstration projects and pioneer conversion facilities involving public-private partnerships, independent expert analysis, stage-gate decision making, and evaluation by the PMC contribute to project risk assessments and go/no-go decisions.

Step 5: Plan and Integrate Throughout the Program Lifecycle.

Step 5 includes crosscutting technical and program integration efforts designed to help Program and Project Managers strengthen their management approaches to ensure a coordinated research and development effort, in addition to a well-integrated approach to technology demonstration and deployment. The diversity of technology options in each supply chain element and the distribution from applied science through development to demonstration and deployment lead to significant decision-making challenges.

3.1.1 Portfolio Analysis and Management

Portfolio analysis is carried out to determine the optimum portfolio of technologies and projects to achieve the Program's performance and market targets. Factors considered include the level of benefits expected, scope, cost, schedule, and risk to realizing the program benefits. This is an iterative process that weighs benefits against costs and risks while taking into account the latest external information regarding market, technical status, and barriers. The process also incorporates the updated status of portfolio efforts based on verified, externally reviewed progress.

Portfolio management is not just a static annual activity, but rather is one that is ongoing and synchronized to the budget cycle over several years. Each year on a continuing basis, the Program reevaluates its goals and barriers, technical and market targets, and portfolio of technologies across the RDD&D spectrum; the Program then uses that information to assess its progress. Every year, there is a new set of decisions associated with populating the RDD&D pipeline with new R&D projects, assessing the performance of ongoing development and demonstration projects, and down-selecting—via the Stage-Gate process—the most promising projects and ceasing to fund those projects that are not performing or otherwise failing to address the Program’s goals.

The Biomass Program’s efforts to improve its portfolio management, analysis, and assessment efforts are supported by the Biomass Systems Integration Office. The focus of systems integration analysis is to understand the complex interactions between new technologies, system costs, environmental impacts, societal impacts, system tradeoffs, and penetration into existing systems and markets. The goals of integrated baseline management are to provide and maintain the links between the program areas. Top-down technical baseline management evaluates the links between the mission and strategies, performance and goals, and milestones and decision points of the Program. Bottom-up programmatic baseline management evaluates the links of the scope, budget, and schedule of each individual project, as well as activities of the Program.

3.2 Performance Assessment

Performance assessment includes performance monitoring, as well as program and project evaluation. It provides the means to measure relevant outputs and outcomes that aid the Program in reevaluating its decisions, goals, and approaches and tracks the actual progress being made. By design, the assessment processes provide input on Program progress and effectiveness from other government agencies, stakeholders, and independent expert reviewers.

Table 3-1: Program and Project-Level Assessments that Support Decision-Making

Assessment Type		Assessment Synopsis	Documentation
Performance Monitoring	<i>External Monitoring</i>	DOE's Annual Performance Target Tracking System	Annual Performance Target Reports
	<i>Internal Monitoring</i>	EERE's Corporate Planning System (CPS)	CPS Database/Website
		Project Monitoring with PMC Quarterly Reports	PMC Project Management Database
	Program Monitoring with Integrated Baseline Update	CORE ¹ Integrated Baseline Reports	
Program Evaluation	<i>Peer Reviews</i>	Conducted by independent experts outside of the program portfolio to assess quality, productivity, and accomplishments, as well as relevance of program success to EERE strategic and programmatic goals; and management ²	Public Summary Documents Including Program Response
	<i>General Program Evaluation Studies</i>	Conducted by independent external experts to examine process, quantify outcomes or impacts, identify market needs and baselines, or quantify cost-benefit measures as appropriate ³	Public Reports and Documentation
Performance Monitoring and Program Evaluation	<i>Technical Program Reviews</i>	EERE Senior Management	EERE Internal
		Biomass R&D Technical Advisory Committee	Report to Congress (Including Program Response)
	<i>Technical Project Reviews</i>	Stage-Gate Reviews conducted by DOE only for public-private demonstration projects, DOE plus independent industry, academia, or other government for pre-competitive R&D projects	Internal Reports for Public-Private Demonstration Projects and Public Information for Pre-Competitive R&D Projects

¹ CORE is a systems engineering software package.

Performance Monitoring

External Performance Monitoring

The Office of Management and Budget (OMB) monitors program performance against technical Annual Performance Targets. Each program is responsible for establishing and monitoring quarterly milestones, as well as meeting Annual Performance Targets established in Congressional Budget Requests.

Internal Performance Monitoring

The Program utilizes the Corporate Planning System (CPS) to help formulate, justify, manage, and execute Congressional Budget Requests. CPS also serves as a management tool to enable prospective spend planning, project data collection, and portfolio performance assessment. The system stores project-level management data, such as scope, schedule, and cost and tracks progress against technical milestones.

The performance of the projects (“agreements” in CPS) is monitored and managed by the PMC. Standardized processes used include:

- PMPs are developed to provide details of work planned throughout the entire project duration, as well as to establish measures for evaluating performance. The plans include multi-year descriptions, milestones, schedules, and cost projections. The PMPs are updated annually.
- Quarterly project progress reports are submitted by the funded organizations outlining financial and technical status, identifying problem areas, and highlighting achievements. The PMC performs a quarterly assessment of project progress against the planned scope and schedule and financial performance against the cost projection and documents the assessment in a quarterly management report.
- The performance of major demonstration and deployment projects is also monitored by headquarters staff and the PMC through Comprehensive Annual Project Reviews. The results of these reviews are used for program portfolio management and program planning.

With more than 150 projects in the Program portfolio, the project plan and progress information must be summarized and synthesized in order to evaluate overall program performance in a meaningful way. The Program has implemented a systems engineering approach and established integrated technical plans across the Program elements to achieve the Program goals. The Program has also developed its integrated baseline, which links the platform-based project activities with resource-based milestones, illuminating gaps/issues in the current project portfolio and providing the foundation for data-driven decision-making by the Program management.

The Program uses additional systems engineering approaches, including interface management, independent performance verification, and robust information management tools to monitor overall progress toward achieving technical goals. The integrated baseline is updated annually at a minimum, using project data and information. The updates monitor risks and identify critical technical gaps, cost overruns, and schedule slippages.

Program Evaluation

Peer Reviews

The Biomass Program uses an external peer review process to assess the performance of the platform technical elements, as well as the Program as a whole. The Program implements the peer review process through a combination of subprogram platform element peer reviews and an overall Program peer review, which are conducted at least biennially. The emphasis of the Program peer review is on the Multiyear Program Plan and the portfolio as a whole to determine whether or not it is balanced, organized, and performing appropriately. In contrast, the emphasis of the subprogram platform reviews is on the composition of projects that comprise the respective elements and whether or not those projects are performing appropriately and contributing to platform goals.

The Program peer review evaluates the RDD&D contributions of the subprogram platform elements toward the overall Program goals, as well as the processes, organization, management, and effectiveness of the Biomass Program. The review is led by an independent steering committee that selects independent experts to review both the Program and technical element or platform portfolios. The results of the review provide the feedback on the performance of the Program and its portfolio, identifying opportunities for improved Program management, as well as gaps or imbalances in funding that need to be addressed. By addressing these gaps and imbalances, the Program will continue to stay focused on the highest priorities.

The subprogram platform peer reviews are conducted prior to the Program review. Information and findings from the platform peer reviews are incorporated into the comprehensive Program peer review process. The objectives of the subprogram platform peer review meetings are as follows:

- Review and evaluate RDD&D accomplishments and future plans of Program projects in a subprogram element following the process guidelines of the EERE Peer Review Guide and incorporating the project evaluation criteria used in the Program Stage-Gate Management Process⁴
- Define and communicate Program strategic and performance goals applicable to the projects in the platform element
- Provide an opportunity for stakeholders and participants to learn about and provide feedback on the projects in the Program portfolio to help shape future efforts so that the highest priority work is identified and addressed
- Foster interactions among industry, universities, and national laboratories conducting the RDD&D, thereby facilitating technology transfer.

Technical experts from industry and academia are selected as reviewers based on their experience in various aspects of biomass technologies under review, including project finance, public policy, and infrastructure. The reviewers score and provide qualitative comments on RDD&D based on the presentations given at the meeting and the background information provided. The reviewers also are asked to identify specific strengths, weaknesses, technology transfer opportunities, and recommendations for modifying project scope.

The Program analyzes all of the information gathered at the review and develops appropriate responses to the findings for each project. This information, including the Program response, is documented and published in a review report that is made available to the public through the Program Web site.⁵

General Program Evaluation Studies

The Biomass Program sponsors several activities and processes that are aligned with the program evaluation studies described in the EERE Guide for Managing General Program Evaluation Studies. The Program is conducting general program evaluations based on this guide, including the following:

- Needs/Market Assessment Evaluations
- Outcome Evaluations
- Impact Evaluations
- Cost-Benefit Evaluations

Needs/Market Assessment Evaluations: The Biomass Program has held a number of workshops in the past several years that have brought together stakeholders from federal and state government agencies, industry, academia, trade associations, and environmental organizations. These workshops identified the key needs and opportunities for bio-based fuels, power, and products in the United States. Recent workshops have focused on Feedstock Supply, Bioproducts, Biopower, and Algae.

Outcome, Impact, and Cost/Benefit Evaluations: These types of evaluations are carried out by PBA and were described previously in the Benefits Analysis portion of section 2.7.

Performance Monitoring and Program Evaluation

Technical Program Reviews

The Biomass Program uses several forms of technical review to assess progress and promote Program and project improvement: Biomass R&D Technical Advisory Committee program reviews, EERE strategic program reviews, and technical project reviews according to the Biomass Program Stage-Gate management process.

The Biomass Technical Advisory Committee reviews the joint USDA/DOE Biomass R&D portfolio annually and provides advice to the Secretary of Energy and Secretary of Agriculture concerning the technical focus and direction of the portfolios. Periodic reports are submitted to Congress by the Committee.⁶ Internally, DOE-EERE senior management holds periodic strategic program review meetings with the Biomass Program Manager for various purposes, including preparation for Congressional budget submission and evaluation of strategic direction.

Technical Project Reviews

The Program also holds stage-gate reviews at the project level. The stage-gate process, as depicted in Figure 3-3, is an approach for making disciplined decisions about research and development that lead to focused process and/or product development efforts.⁷ Specifically, the Program uses the stage-gate process to inform decisions regarding the following:

- Which projects to carry forward in the Program’s technology portfolio
- The alignment of R&D project objectives with Program objectives and industry needs
- Distribution of Program funding across the spectrum of Technology Readiness Levels within the spectrum of RDD&D activities
- Guidance on project definition, including scope, quality, outputs, and integration
- Evaluation of projects for progress and alignment with the Program portfolio.

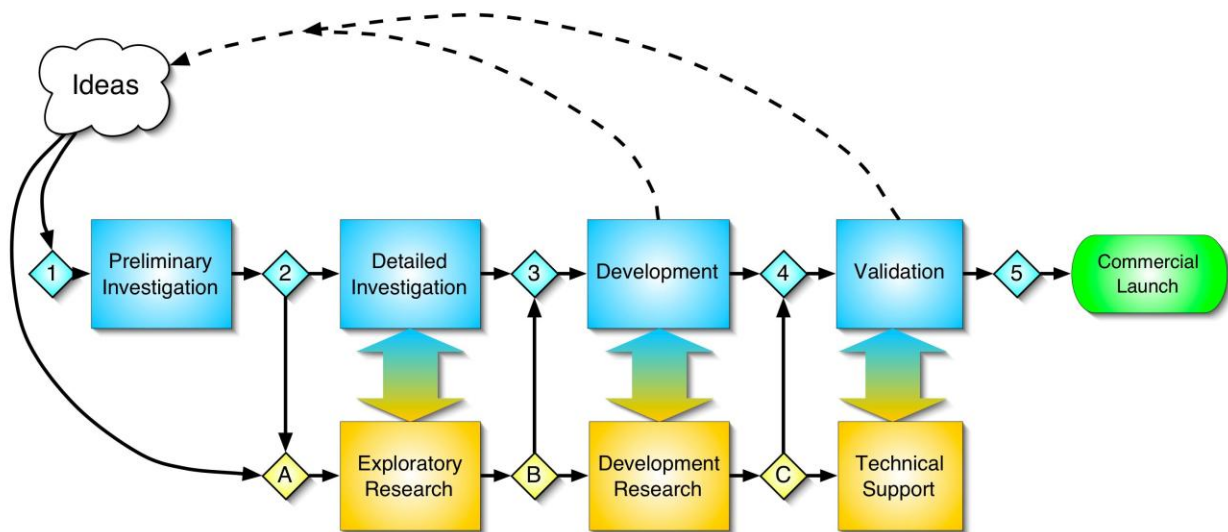

Figure 3-3: Biomass Program Stage-Gate Process

Stage-Gate Reviews: Each stage is preceded by a decision point or gate which must be passed through before work on the next stage can begin. Gate reviews are conducted by a combination of internal management and outside experts or the gate-keepers. The purpose of each gate is twofold: first, the project must demonstrate that it met the objectives identified in the previous gate and stage plan; and second, that it satisfies the criteria for the current gate. A set of seven types of criteria are used to judge a project at each gate:

- Strategic Fit
- Market/Customer
- Technical Feasibility and Risks
- Competitive Advantage
- Legal/Regulatory Compliance
- Critical Success Factors and Show Stoppers
- Plan to Proceed.

Specific criteria are different for each gate and become more rigorous as the project moves along the development pathway.

The possible outcomes of this portion of the review could be passing, recycle, hold, or stop. Passing implies that the goals for the previous stage were met and everything looks good for authorization to proceed.

Recycling indicates that working longer in the current stage is justified—all goals have not been accomplished, but the project still has a high priority and potential looks promising.

Hold suspends a project because the need for it may have diminished or disappeared. There is an implication that the market demand could come back and the project could be resumed later.

Stopping a project might occur because the technology development is not progressing as it should, the market appears to have shifted permanently, the technology has become obsolete, or the economic advantage is no longer there. In this case, the best ideas from the project are salvaged, but the project is permanently halted.

The second half of the gate review takes place if the decision is made that the project “passes” the gate. The project leader must propose a project definition and preliminary plan for the next stage, including objectives, major milestones, high-level work breakdown structure, schedule, and resource requirements. The plan must be presented in sufficient detail for the reviewers to comment on the accomplishments necessary for the next stage, as well as the goals for completion of the next gate. Once the plan is accepted, the project can move to the next stage. Since the stakes get higher with each passing stage, the decision process becomes more complex and demanding. If the decision is made to “recycle” the project, the review panel will provide suggestions to the project leader on work that needs to be completed satisfactorily before the next gate review is held. In the case of a “hold” or “stop” decision, the plan to proceed is not needed.

An overview of the Biomass Program stage-gate process is available online at <http://devafdc.nrel.gov/pdfs/9276.pdf>. The stage-gate process is a key portfolio management tool because it integrates a number of key decision areas, all of which are challenging:

- Project selection and prioritization
- Resource allocation across projects
- Implementation of business strategy.

The gates and gate reviews allow the Program to filter poor performing or off-the-target projects and reallocate resources to the best projects and/or open the way for new projects to begin.







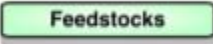
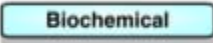
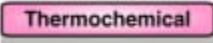

Endnotes

- ¹ The EERE Program Management Initiative was launched in 2003 to address stakeholder expectations, the President's Management Agenda, DOE and EERE strategic plans, findings and recommendations by the National Academy of Public Administration, and the Government Performance and Results Act. Complete information is available at http://www1.eere.energy.gov/ba/prog_mgmt_initiative.html.
- ² EERE Peer Review Guide. U.S. Department of Energy, Office of Energy Efficiency and Renewable Energy, August 2004. <http://www1.eere.energy.gov/ba/pdfs/2004peerreviewguide.pdf>, accessed 10/6/06.
- ³ "EERE Guide for Managing General Program Evaluation Studies: Getting the Information You Need," DOE/EERE. February 2006.
- ⁴ Stage Gate Management in the Biomass Program, (Revision 2, February 2005). <http://devafdc.nrel.gov/pdfs/9276.pdf>, accessed 10/11/06.
- ⁵ Recent element review website: <http://obpreview2009.govtools.us/>
- ⁶ The most recent report, Annual Report to Congress on the Biomass Research and Development Initiative for 2006, can be accessed at <http://www.brdisolutions.com/Site%20Docs/Biomass%20Initiative%20Report%20to%20Congress%20FY%202006.pdf>.
- ⁷ Stage Gate Management in the Biomass Program, (Revision 2, February 2005). <http://devafdc.nrel.gov/pdfs/9276.pdf>, accessed 10/11/06.

Appendix A: Biomass Program Structure

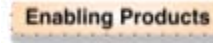
High-level block flow diagrams for each Program biorefinery pathway are presented in Figures A-1 through A-5. These diagrams show the current process (if it exists today) and current products including fuels, chemicals and power, options for improvements, and associated new products. *These diagrams are not intended to be all inclusive; many other viable processing options are possible.* These diagrams do not display options for pathways which are considered mature commercial technology.

The blocks and paths on the diagrams are coded as follows:

-  **Feedstocks** – Feedstocks R&D
-  **Biochemical** – Biochemical Conversion R&D
-  **Thermochemical** – Thermochemical Conversion R&D
-  **Bold blocks** – Highest priorities
-  **Dash blocks** – Medium and low priorities
-  – New routes to biofuels, with the heavy lines indicating the highest priority routes
-  **Enabling Products** – Potential new enabling non-fuel products
-  **OR**  – Existing processing steps in current biorefineries
-  – Indicates that an “option” exists on how to process the stream. The options must be evaluated and compared against each other to identify the best overall pathway configuration. For pathways representing existing industry segments, the options include the status quo. The options analysis may compare options that would take the full stream or fractions of the full stream. The ability to add and evaluate options within a pathway results in a flexible framework for considering innovative new ideas in the future.

The Program Work Breakdown Structure, shown in Table A-1, shows the necessary program activities being pursued to address the critical RDD&D challenges in the biorefinery pathways. Priority feedstock pathways denoted in bold font represent the primary RDD&D focus of the specific activity.

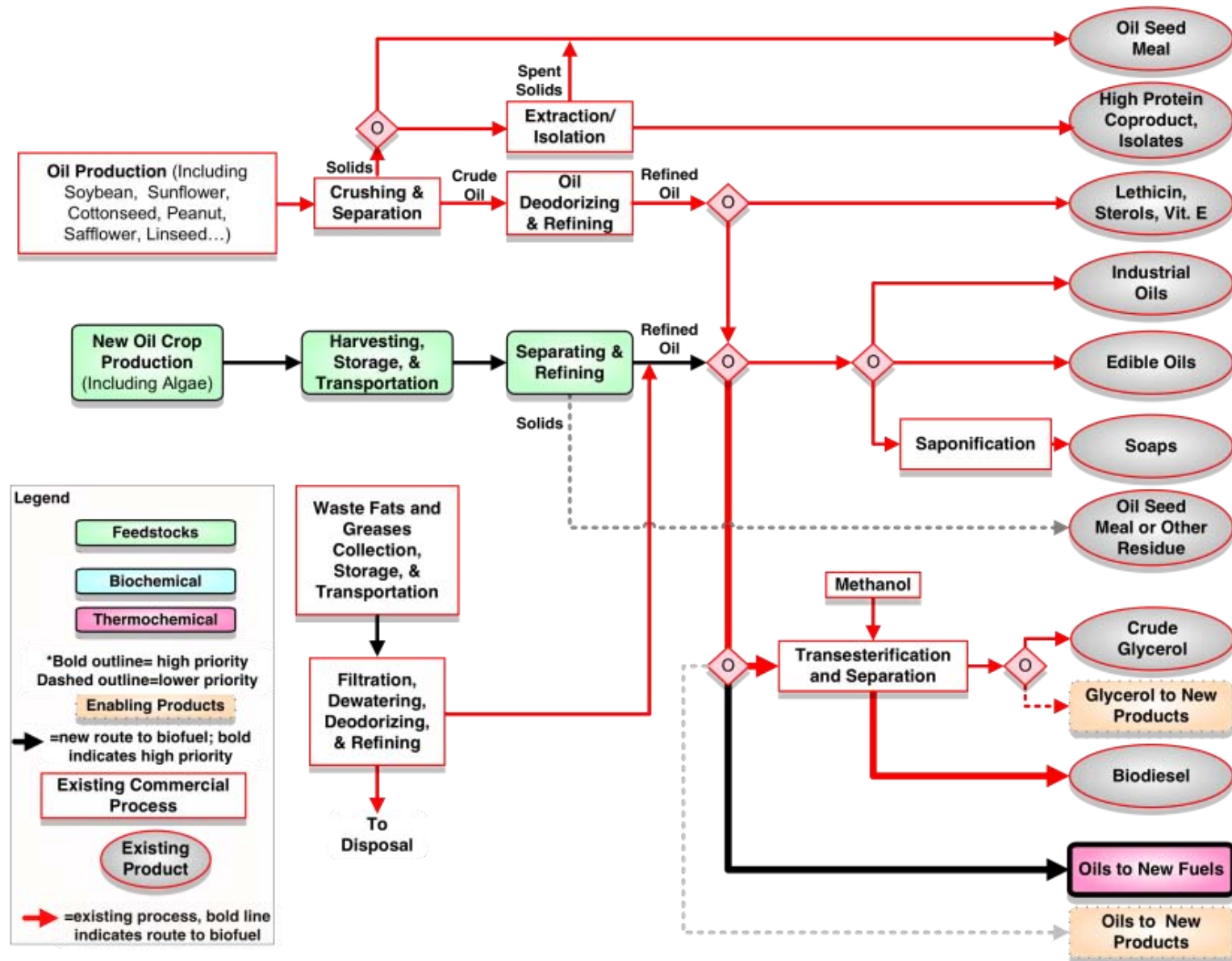

Figure A-1: Natural Oils Pathway

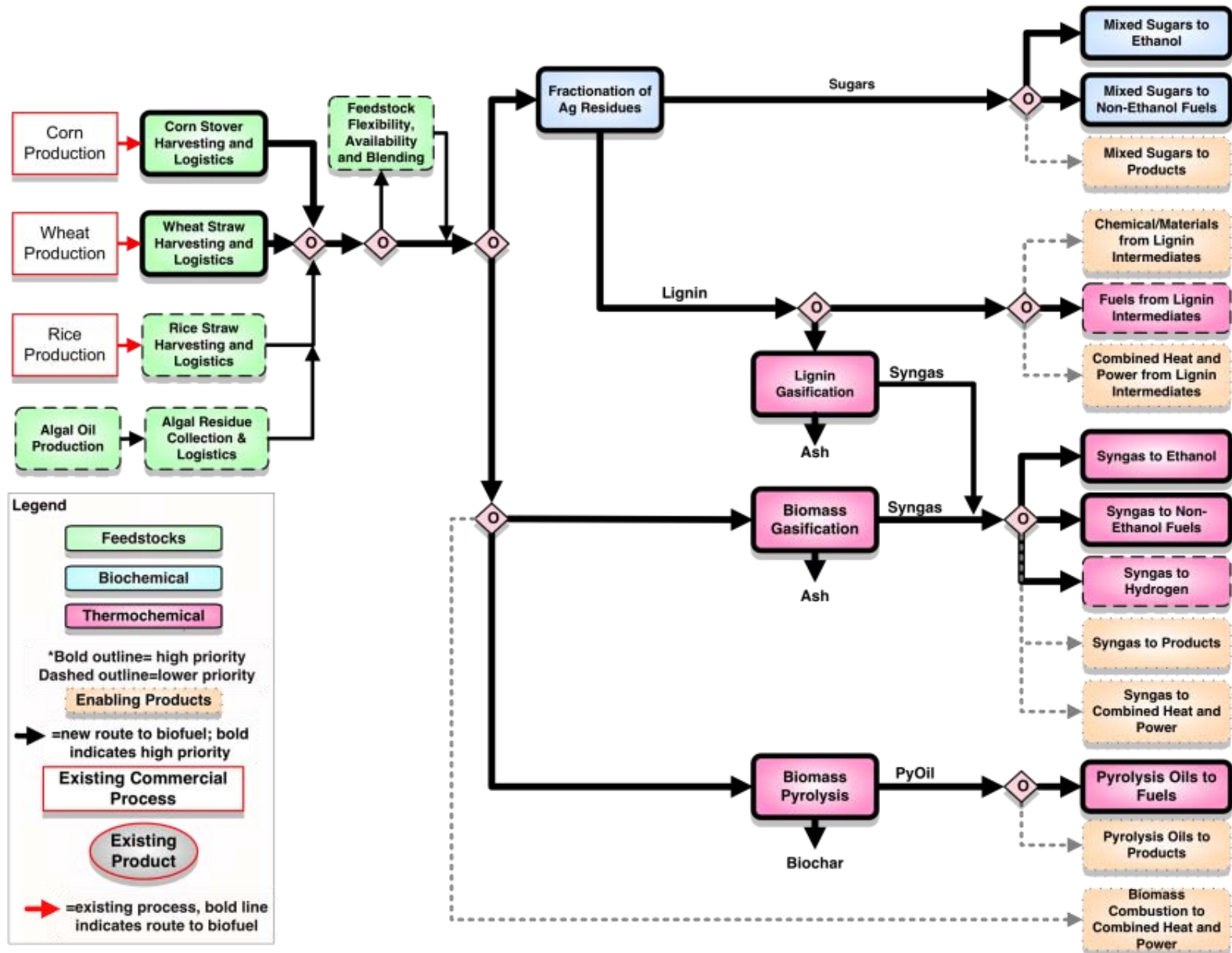

Figure A-2: Agricultural Residues Pathway
A-3

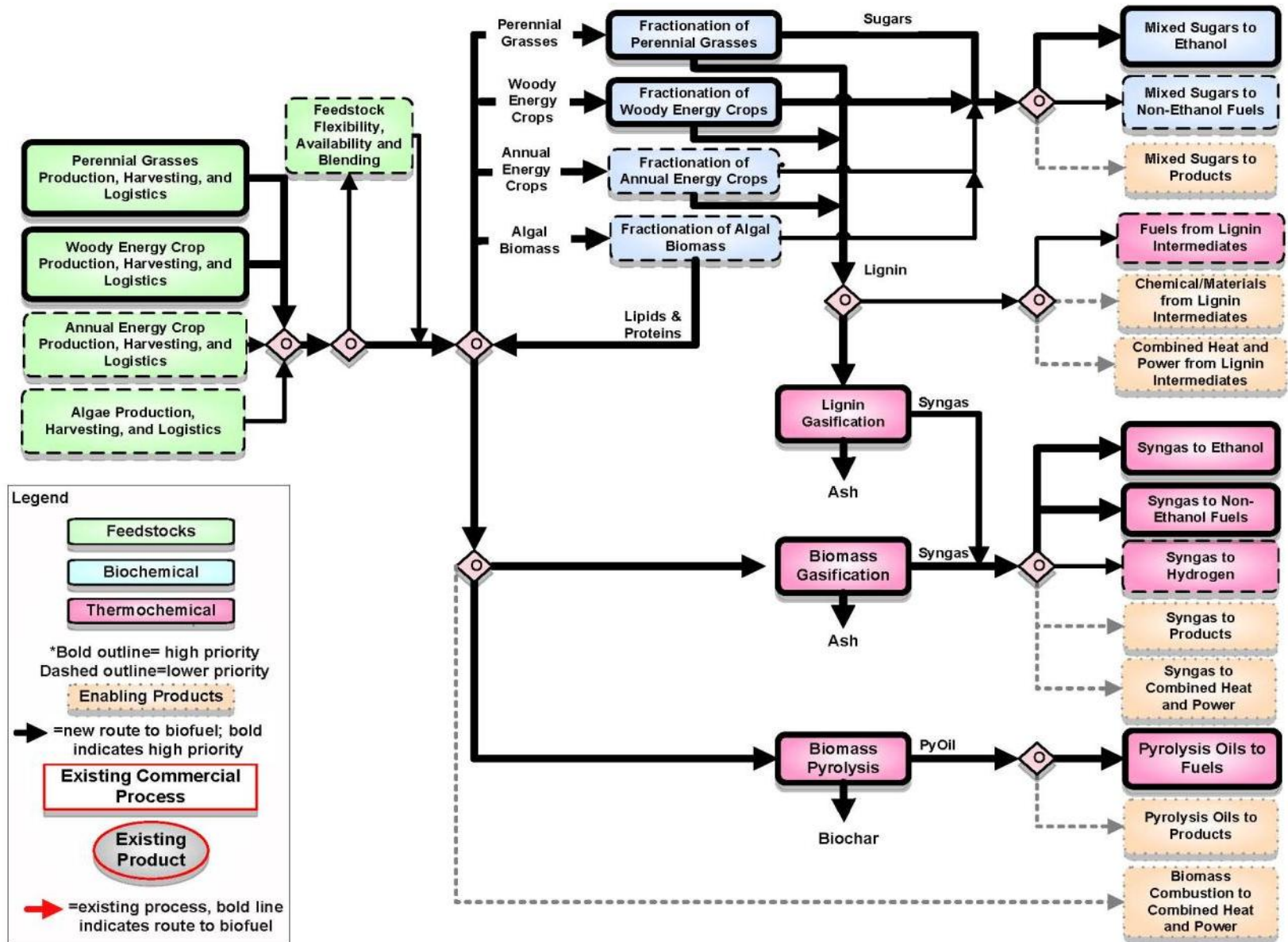

Figure A-3: Energy Crops Pathway

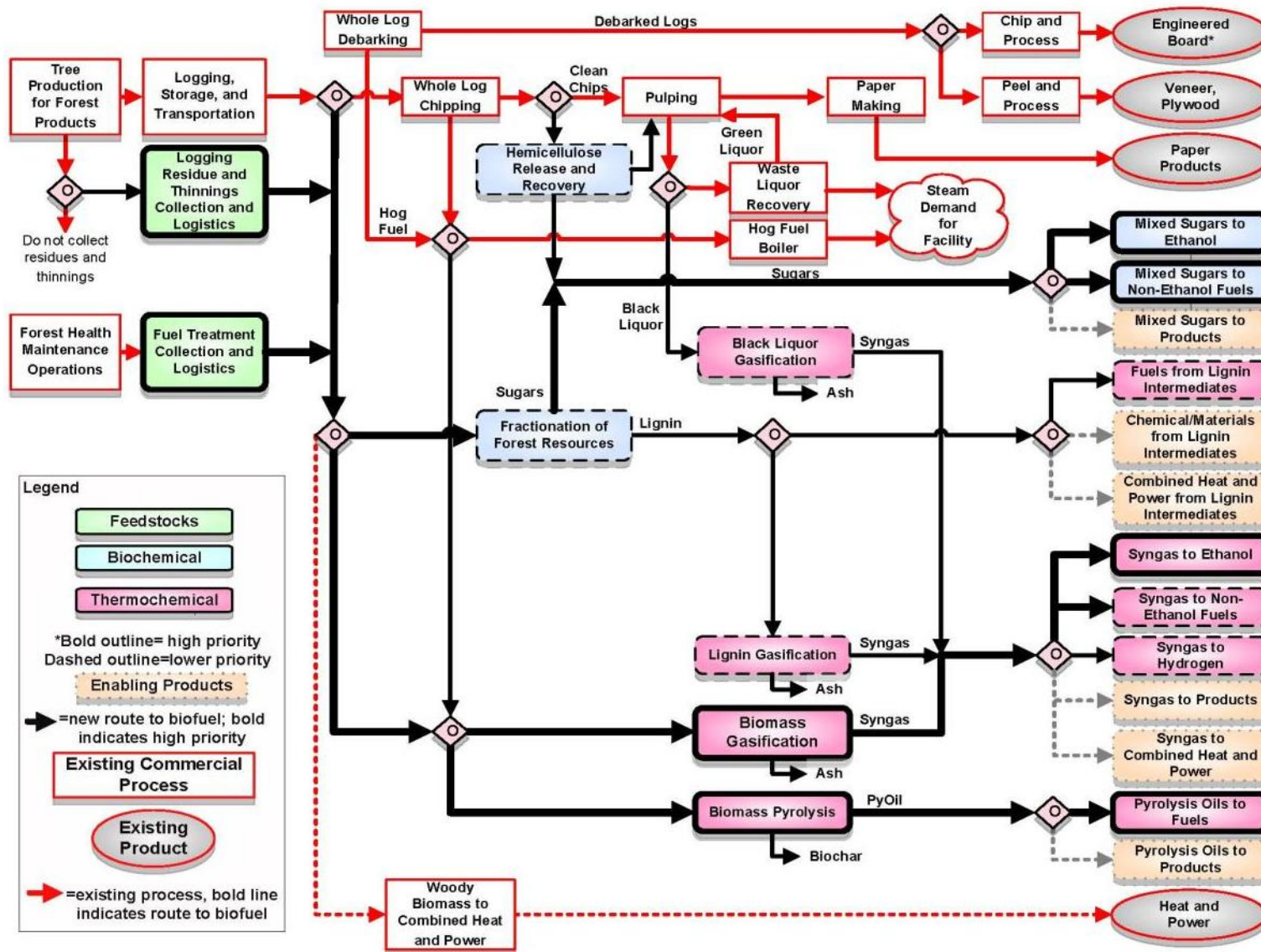

Figure A-4: Forest Resources Pathway

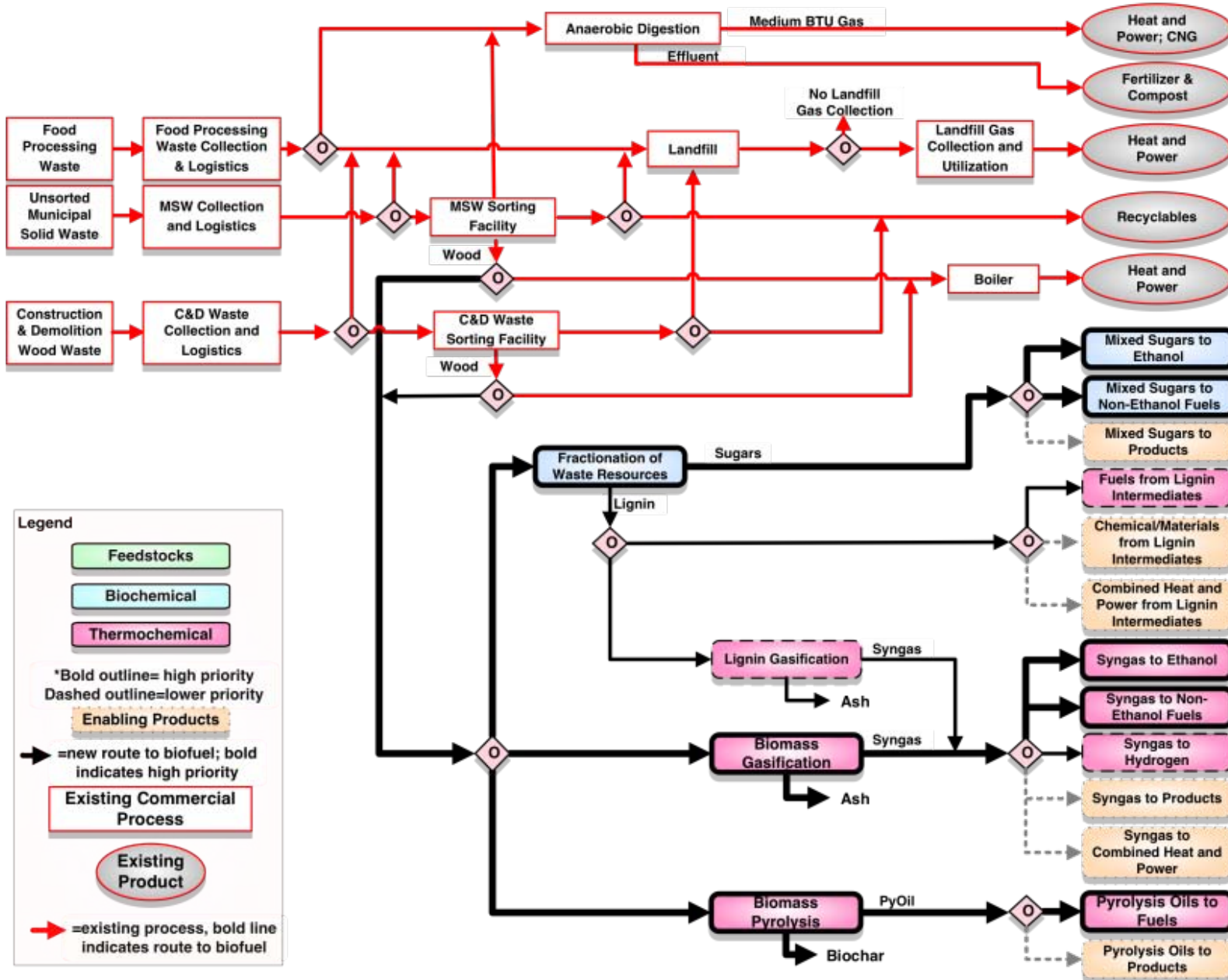

Figure A-5: Waste Pathway
A-6

Appendix B: Technical Projection Tables

Table B-1: Technical Projections for Biomass Feedstock Production

Processing Area Cost Contribution & Key Technical Parameters	Metric	Corn Stover			Cereal Straw			Switchgrass			Woody Feedstocks		
		2007	2012	2017	2007	2012	2017	2007	2012	2017	2007	2012	2017
Process Concept: Herbaceous Biomass Production, Standing in Field		2007	2012	2017	2007	2012	2017	2007	2012	2017	2007	2012	2017
Year \$ basis		2007	2007	2007	2007	2007	2007	2007	2007	2007	2007	2007	2007
Grower/*Stumpage Payment	\$/dry ton	\$15.90	\$15.90	\$26.20	\$15.90	\$15.90	\$26.20	\$15.90	\$15.90	\$26.20	\$15.70	\$15.70	\$26.20
Tonnage Potential at or below Grower Payment	millions of dry tons/yr	1.4	58.0	96.6	12.8	19.7	19.7	0.0	10.9	52.0	0.0	41.0	82.0
Percent Dry Feedstock (< 15% moisture)	%	100	4	2	100	100	100	0	60	29	0	0	0
Feedstock Production Case Reference	Threshold Cost-Tonnage Analysis 09- 04-06; INL Feedstock Model 2007 Actual SOT 09-22-08												

* For Woody Feedstocks

Table B-2. Unit Operation Cost Contribution Estimates (2007\$) and Technical Projections for Dry Herbaceous Biomass Feedstock Collection, Preprocessing and Delivery to Conversion Reactor Inlet

Processing Area Costs Contributions & Key Technical Parameters	Field Dried Corn Stover							All Herbaceous Feedstocks
	Metric	2007 SOT [†]	2008 SOT [†]	2009 SOT [†]	2010 Projected	2011 Projected	2012 Projected	2017 Projected
Process Concept: Feedstock Harvest through insertion to Conversion Reactor Inlet	Year \$ basis	2007	2007	2007	2007	2007	2007	2007
Total Feedstock Cost	\$/DM ton	\$69.60	\$65.30	\$62.05	\$53.70	\$52.00	\$50.90	\$61.20
Total cost of feedstock logistics	\$/DM ton	\$53.70	\$49.40	\$46.15	\$37.80	\$36.10	\$35.00	\$35.00
Capital Cost Contribution	\$/DM ton	\$13.45	\$11.70	\$10.65	\$10.55	\$9.90	\$11.20	\$11.20
Operating Cost Contribution	\$/DM ton	\$40.25	\$37.70	\$35.50	\$27.25	\$26.20	\$23.80	\$23.80
Total cost of grower payment	\$/DM ton	\$15.90	\$15.90	\$15.90	\$15.90	\$15.90	\$15.90	\$26.20
Harvest and Collection								
Total Cost Contribution	\$/DM ton	\$20.35	\$16.60	\$13.30	\$13.80 [†]	\$13.80	\$12.15	\$12.15
Capital Cost Contribution	\$/DM ton	\$7.25	\$6.20	\$5.25	\$5.20	\$5.20	\$6.60	\$6.60
Operating Cost Contribution	\$/DM ton	\$12.10	\$10.40	\$8.05	\$8.60	\$8.60	\$6.55	\$6.55
Harvest & Collection Efficiency	%	32%	36%	36%	39%	39%	75%	75%
Collection Bulk Density	DM lbs/cu-ft	8.5	9.6	10.1	12.0	12.0	12.0	> 12
Storage and Queuing								
Total Cost Contribution	\$/DM ton	\$7.25	\$6.30	\$7.25	\$3.50	\$2.65	\$2.45	\$2.45
Capital Cost Contribution	\$/DM ton	\$1.10	\$0.90	\$1.00	\$1.90	\$1.40	\$1.40	\$1.40
Operating Cost Contribution	\$/DM ton	\$6.15	\$5.40	\$6.25	\$1.60	\$1.25	\$1.05	\$1.05
Shrinkage	% dry matter loss	5.0%	5.0%	5.0%	7.9%*	6.0%	5.0%	< 5%
Preprocessing								
Total Cost Contribution	\$/DM ton	\$12.40	\$14.60**	\$14.15	\$11.45	\$10.65	\$11.50	\$11.50
Capital Cost Contribution	\$/DM ton	\$2.90	\$2.65	\$2.60	\$1.95	\$1.80	\$1.90	\$1.90
Operating Cost Contribution	\$/DM ton	\$9.50	\$11.95	\$11.55	\$9.50	\$8.85	\$9.60	\$9.60
Capacity	kW-hr/DM ton	27.3	47.2	46.6	38.0	34.9	34.8	< 20
Transportation and Handling								
Total Cost Contribution	\$/DM ton	\$13.70	\$11.90	\$11.45	\$9.05	\$9.00	\$7.90	\$7.90
Capital Cost Contribution	\$/DM ton	\$2.10	\$1.85	\$1.80	\$1.50	\$1.50	\$1.30	\$1.30
Operating Cost Contribution	\$/DM ton	\$11.60	\$10.05	\$9.65	\$7.55	\$7.50	\$6.60	\$6.60
Feedstock Format	Bale-Bulk	4' x 4' sqr.	4' x 4' sqr.	4' x 4' sqr.	3' x 4' sqr.	3' x 4' sqr.	3' x 4' sqr.	Bulk
Feedstock Costs								
Total Feedstock Cost	\$/DM ton	\$69.60	\$65.30	\$62.05	\$53.70	\$52.00	\$50.90	\$32.00
Logistics Cost	\$/DM ton	\$53.70	\$49.40	\$46.15	\$37.80	\$36.10	\$35.00	\$35.00

Processing Area Costs Contributions & Key Technical Parameters	Field Dried Corn Stover							All Herbaceous Feedstocks
	Metric	2007 SOT [†]	2008 SOT [†]	2009 SOT [†]	2010 Projected	2011 Projected	2012 Projected	2017 Projected
Process Concept: Feedstock Harvest through insertion to Conversion Reactor Inlet								
Grower Payment Cost	\$/DM ton	\$15.90	\$15.90	\$15.90	\$15.90	\$15.90	\$15.90	\$27.00
Particle Size	inch	< 0.5	< 0.25	< 0.25	< 0.25	< 0.25	< 0.25	< 0.25
Moisture Content	% (wet basis)	12%	12%	12%	12%	12%	12%	12%
Carbohydrate Content	% (dry basis)	64.9%	64.9%	64.9%	64.9%	64.9%	64.9%	64.9%
Feedstock Case Reference (model run #): MYPP SOT-Projections INL061610								

[†]SOT: State of Technology

[‡]Change in baling technology increased unit operation cost but contributed to an over cost decrease.

*Change in storage technology increased dry matter loss but decreased overall unit operation cost.

**Additional grinder included to decrease particle size and meet target specification. Cost recovered in FY10.

Table B-3. Technical Projections for Dry Woody Feedstocks Collection, Preprocessing and Delivery to Conversion Reactor Inlet¹

Year	Harvest and Logistics	Grower Payment	Total Delivered Cost to Reactor Throat
	\$/dry US ton	\$/dry US ton	\$/dry US ton
2007	51.85	15.70	67.55
2008	47.80	15.70	63.50
2009	42.50	15.70	58.20
2010	38.50	15.70	54.20
2011	36.10	15.70	51.80
2012	35.00	15.70	50.70
2017	35.00	26.20	61.20

Table B-4: Unit Operation Cost Contribution Estimates (2007\$) and Technical Projections for Biochemical Conversion to Ethanol Baseline Process Concept

(Process Concept: Dry Corn Stover, Dilute Acid Pretreatment, Enzymatic Hydrolysis and Co-Fermentation, Lignin Combustion for Combined Heat and Power)

Processing Area Cost Contributions & Key Technical Parameters	Metric	2005 SOT [†]	2007 SOT [†]	2008 SOT [†]	2009 Projection	2010 Projection	2011 Projection	2012 Projection
Process Concept: Dilute Acid Pretreatment, Enzymatic Hydrolysis, Ethanol Fermentation and Recovery, Lignin Combustion for CHP		Corn Stover	Corn Stover	Corn Stover	Corn Stover	Corn Stover	Corn Stover	Corn Stover
Conversion Contribution	\$/gal	\$1.79	\$1.72	\$1.71	\$1.62	\$1.33	\$1.08	\$0.92
Year \$ basis		2007	2007	2007	2007	2007	2007	2007
EIA Reference Case [†]	\$/GGE*		\$2.18	\$2.57	\$1.69	\$2.29	\$2.47	\$2.62
	\$/gal EtOH		\$1.46	\$1.72	\$1.13	\$1.53	\$1.66	\$1.76
Projected Minimum Ethanol Selling Price	\$/gal EtOH	\$2.85	\$2.69	\$2.61	\$2.36	\$1.98	\$1.68	\$1.49
Total Project Investment per Annual Gallon	\$	\$5.86	\$4.81	\$4.87	\$4.49	\$4.00	\$3.66	\$3.31
Plant Capacity (Dry Feedstock Basis)	Tonnes/day	2000	2000	2000	2000	2000	2000	2000
Ethanol Yield	gal EtOH/dry US ton	65.3	71.9	72.6	77.7	82.7	87.1	89.9
Feedstock								
Total Cost Contribution	\$/gal EtOH	\$1.07	\$0.97	\$0.90	\$0.74	\$0.65	\$0.60	\$0.57
Capital Cost Contribution	\$/gal EtOH	\$0.00	\$0.00	\$0.00	\$0.00	\$0.00	\$0.00	\$0.00
Operating Cost Contribution	\$/gal EtOH	\$1.07	\$0.97	\$0.90	\$0.74	\$0.65	\$0.60	\$0.57
Carbohydrate Content	% (dry Basis)	64.9%	64.9%	64.9%	64.9%	64.9%	64.9%	64.9%
Feedstock Cost	\$/dry US ton	\$69.60	\$69.60	\$65.30	\$57.50	\$53.70	\$52.00	\$50.90
Prehydrolysis/ treatment								
Total Cost Contribution	\$/gal EtOH	\$0.50	\$0.51	\$0.50	\$0.47	\$0.44	\$0.36	\$0.26
Capital Cost Contribution	\$/gal EtOH	\$0.22	\$0.19	\$0.20	\$0.19	\$0.18	\$0.17	\$0.13
Operating Cost Contribution	\$/gal EtOH	\$0.28	\$0.32	\$0.30	\$0.28	\$0.27	\$0.19	\$0.13
Solids Loading	wt%	30%	30%	30%	30%	30%	30%	30%
Xylan to Xylose	%	63%	75%	75%	80%	85%	88%	90%
Xylan to Degradation Products	%	13%	13%	11%	8%	6%	5%	5%
Xylan Sugar Loss	%	13%	2%	2%	2%	2%	1%	1%
Glucose Sugar Loss	%	12%	1%	1%	1%	1%	1%	0%
Enzymes								
Total Cost Contribution	\$/gal EtOH	\$0.35	\$0.35	\$0.35	\$0.35	\$0.17	\$0.12	\$0.12
Capital Cost Contribution	\$/gal EtOH	N/A	N/A	NA	N/A	NA	NA	NA
Operating Cost Contribution	\$/gal EtOH	\$0.35	\$0.35	\$0.35	\$0.35	\$0.17	\$0.12	\$0.12
Saccharification & Fermentation								
Total Cost Contribution	\$/gal EtOH	\$0.35	\$0.34	\$0.33	\$0.31	\$0.26	\$0.17	\$0.12

Appendix B: Technical Projection Tables

Processing Area Cost Contributions & Key Technical Parameters	Metric	2005 SOT [†]	2007 SOT [†]	2008 SOT [†]	2009 Projection	2010 Projection	2011 Projection	2012 Projection
Capital Cost Contribution	\$/gal EtOH	\$0.14	\$0.13	\$0.12	\$0.12	\$0.08	\$0.06	\$0.06
Operating Cost Contribution	\$/gal EtOH	\$0.21	\$0.21	\$0.21	\$0.19	\$0.17	\$0.11	\$0.06
Total Solids Loading	wt%	20%	20%	20%	20%	20%	20%	20%
Combined Sacc./Fermentation Time	days	7	7	7	7	7	5	3
Overall Cellulose to Ethanol	%	86%	86%	86%	86%	86%	86%	86%
Xylose to Ethanol	%	76%	76%	80%	80%	80%	85%	85%
Minor Sugars to Ethanol	%	0%	0%	0%	40%	80%	85%	85%
Distillation & Solids Recovery								
Total Cost Contribution	\$/gal EtOH	\$0.21	\$0.19	\$0.19	\$0.18	\$0.17	\$0.17	\$0.16
Capital Cost Contribution	\$/gal EtOH	\$0.16	\$0.15	\$0.15	\$0.14	\$0.13	\$0.13	\$0.13
Operating Cost Contribution	\$/gal EtOH	\$0.05	\$0.04	\$0.04	\$0.04	\$0.04	\$0.04	\$0.03
Steam Use	lb stm/gal EtOH	46	46	45	42	40	40	40
Balance of Plant								
Total Cost Contribution	\$/gal EtOH	\$0.37	\$0.32	\$0.33	\$0.31	\$0.29	\$0.27	\$0.26
Capital Cost Contribution	\$/gal EtOH	\$0.43	\$0.39	\$0.39	\$0.36	\$0.32	\$0.30	\$0.28
Operating Cost Contribution	\$/gal EtOH	-\$0.06	-\$0.07	-\$0.06	-\$0.05	-\$0.03	-\$0.03	-\$0.02
Co-Product Credit - Electricity	\$/gal EtOH	-\$0.17	-\$0.13	-\$0.13	-\$0.11	-\$0.09	-\$0.08	-\$0.08
Co-Product Credit - Other	\$/gal EtOH	0	0	0	0	0	0	0
Electricity Production	KWHr/gal EtOH	4.4	3.27	3.3	2.7	2.3	2.1	1.9
Water Consumption	gal H ₂ O/Gal EtOH	10.1	9.1	9.4	8.5	7.7	6.9	6.3
Fuel Ethanol Case Reference (Model Run #)		DW-J0507B	DW0810R	DW0810Z	DW0810Y	DW0810T	DW0810U	DW0810V

[†] SOT: State of Technology

* 0.67 gallon gasoline/gallon ethanol conversion factor

[‡] EIA, "Annual Energy Outlook 2009", Table 112, U.S., http://www.eia.doe.gov/oiia/archive/aeo09/supplement/suptab_112.xls

Note: 1) The row "moisture content of solids" "% water by wgt" under the subsection Distillation & Solids Recovery has been removed.

2) Microsoft Excel™ when asked to round numbers, presents the rounded numbers in the table, however, upon executing calculations the software utilizes the exact number without rounding in each individual cell. This difference in how the numbers are rounded and added can lead to \$0.01 difference between the summations of the cell contents and the summations of the cell displays.

Table B-5: Unit Operation Cost Contribution Estimates (2007\$) and Technical Projections for Thermochemical Conversion to Ethanol Baseline Process Concept

(Process Concept: Woody Energy Crop, Gasification, Gas Cleanup, Mixed Alcohol Synthesis, Ethanol Recovery and Purification)

Processing Area Cost Contributions & Key Technical Parameters	Metric	2005 SOT [†]	2007 SOT [†]	2008 SOT [†]	2009 Projection	2010 Projection	2011 Projection	2012 Projection
Process Concept: Gasification, Syngas Cleanup, Mixed Alcohol Synthesis & Recovery		Woody Feedstock	Woody Feedstock	Woody Feedstock	Woody Feedstock	Woody Feedstock	Woody Feedstock	Woody Feedstock
Conversion Contribution	\$/gal EtOH	\$1.89	\$1.89	\$1.35	\$1.31	\$1.10	\$0.97	\$0.86
Year \$ basis		2007	2007	2007	2007	2007	2007	2007
EIA Reference Case [‡]	\$/GGE*		\$2.18	\$2.57	\$1.69	\$2.29	\$2.47	\$2.62
	\$/gal EtOH		\$1.46	\$1.72	\$1.13	\$1.53	\$1.66	\$1.76
Projected Minimum Ethanol Selling Price	\$/gal EtOH	\$3.47	\$3.47	\$2.40	\$2.26	\$1.90	\$1.70	\$1.57
Total Project Investment per Annual Gallon	\$	\$8.05	\$8.05	\$5.60	\$5.50	\$4.82	\$4.32	\$4.32
Plant Capacity (Dry Feedstock Basis)	Tonnes/day	2000	2000	2000	2000	2000	2000	2000
Ethanol Yield	gal EtOH/dry ton	42.6	42.7	60.6	61.5	67.5	71.0	71.1
Mixed Alcohol Yield	gal MA/dry ton	50.3	50.3	71.3	72.5	79.6	83.7	83.7
Feedstock								
Total Cost Contribution	\$/gal EtOH	\$1.58	\$1.58	\$1.05	\$0.95	\$0.80	\$0.73	\$0.71
Capital Cost Contribution	\$/gal EtOH	\$0.00	-	-	-	-	-	-
Operating Cost Contribution	\$/gal EtOH	\$1.58	\$1.58	\$1.05	\$0.95	\$0.80	\$0.73	\$0.71
Feedstock Cost	\$/dry US ton	\$67.55	\$67.55	\$63.50	\$58.20	\$54.20	\$51.80	\$50.70
Energy Content (LHV, dry basis)	Btu/lb	8060	8060	8060	8060	8060	8060	8060
Feed Handling and Drying								
Total Cost Contribution	\$/gal EtOH	\$0.27	\$0.27	\$0.19	\$0.19	\$0.17	\$0.16	\$0.16
Capital Cost Contribution	\$/gal EtOH	\$0.20	\$0.20	\$0.14	\$0.14	\$0.13	\$0.12	\$0.12
Operating Cost Contribution	\$/gal EtOH	\$0.07	\$0.07	\$0.05	\$0.05	\$0.04	\$0.04	\$0.04
Feed Moisture Content to Gasifier	wt % H ₂ O	5%	5%	5%	5%	5%	5%	5%
Gasification								
Total Cost Contribution	\$/gal EtOH	\$0.21	\$0.21	\$0.15	\$0.15	\$0.13	\$0.13	\$0.13
Capital Cost Contribution	\$/gal EtOH	\$0.11	\$0.11	\$0.08	\$0.08	\$0.07	\$0.07	\$0.07
Operating Cost Contribution	\$/gal EtOH	\$0.10	\$0.10	\$0.07	\$0.07	\$0.06	\$0.06	\$0.06
Raw Syngas Yield	lb/lb dry feed	0.82	0.82	0.82	0.82	0.82	0.82	0.82
Raw Syngas Methane (dry basis)	Mole %	15%	15%	15%	15%	15%	15%	15%
Gasifier Efficiency (LHV)	% LHV	76.1%	76.1%	76.1%	76.1%	76.1%	76.1%	76.1%
Synthesis Gas Clean-up & Conditioning								
Total Cost Contribution	\$/gal EtOH	\$1.13	\$1.13	\$0.76	\$0.75	\$0.63	\$0.55	\$0.44

Appendix B: Technical Projection Tables

Processing Area Cost Contributions & Key Technical Parameters	Metric	2005 SOT [†]	2007 SOT [†]	2008 SOT [†]	2009 Projection	2010 Projection	2011 Projection	2012 Projection
Capital Cost Contribution	\$/gal EtOH	\$0.60	\$0.60	\$0.41	\$0.41	\$0.35	\$0.30	\$0.30
Operating Cost Contribution	\$/gal EtOH	\$0.53	\$0.53	\$0.35	\$0.35	\$0.28	\$0.25	\$0.14
Tar Reformer (TR) Exit CH ₄ (dry basis)	Mole %	8%	8%	3%	3%	1%	1%	1%
TR Light CH ₄ Conversion	%	20%	20%	50%	50%	80%	80%	80%
TR Benzene Conversion	%	70%	80%	98%	90%	99%	99%	99%
Sulfur Level in Clean Gas (as H ₂ S)	ppmv	50	50	50	50	50	50	50
Fuels Synthesis								
Total Cost Contribution	\$/gal EtOH	\$0.15	\$0.15	\$0.08	\$0.07	\$0.03	(\$0.01)	(\$0.01)
Capital Cost Contribution	\$/gal EtOH	\$0.28	\$0.28	\$0.22	\$0.21	\$0.18	\$0.15	\$0.15
Operating Cost Contribution	\$/gal EtOH	(\$0.13)	(\$0.13)	(\$0.14)	(\$0.14)	(\$0.15)	(\$0.16)	(\$0.16)
Pressure	psia	2000	2000	2000	1500	1500	1500	1500
Single Pass CO Conversion	% CO	40.0%	40.0%	40.0%	40.0%	40.0%	50.0%	50%
Overall CO Conversion	% CO	40.0%	40.0%	40.0%	40.0%	40.0%	50.0%	50%
Selectivity to Alcohols	% CO	80.0%	80.0%	80.0%	80.0%	80.0%	80.0%	80.0%
Product Recovery and Purification								
Total Cost Contribution	\$/gal EtOH	\$0.06	\$0.06	\$0.05	\$0.05	\$0.05	\$0.05	\$0.05
Capital Cost Contribution	\$/gal EtOH	\$0.04	\$0.04	\$0.04	\$0.04	\$0.04	\$0.03	\$0.03
Operating Cost Contribution	\$/gal EtOH	\$0.02	\$0.02	\$0.01	\$0.01	\$0.01	\$0.02	\$0.02
Co-Product Credit - Mixed Alcohols	\$/gal EtOH	\$0.21	\$0.21	\$0.21	\$0.21	\$0.21	\$0.21	\$0.21
Balance of Plant								
Total Cost Contribution	\$/gal EtOH	\$0.11	\$0.11	\$0.12	\$0.12	\$0.10	\$0.10	\$0.10
Capital Cost Contribution	\$/gal EtOH	\$0.24	\$0.24	\$0.14	\$0.13	\$0.12	\$0.11	\$0.11
Operating Cost Contribution	\$/gal EtOH	(\$0.13)	(\$0.13)	(\$0.02)	(\$0.01)	(\$0.02)	(\$0.01)	(\$0.01)
Co-Product Credit - Other	\$/gal EtOH	\$0.16	\$0.16	\$0.00	\$0.00	\$0.02	\$0.01	\$0.01
Electricity Production	KWhr/gal EtOH	5.10	5.10	1.60	1.56	1.69	1.45	1.45
Water Consumption	gal H ₂ O/Gal EtOH	4.0	4.0	2.6	2.1	3.2	2.8	2.8
Fuel Ethanol Case Reference (Model Run #)		AD200812-mypp2008-FY05-2007\$Actual	AD200812-mypp2008-FY07-2007\$Actual	AD200812-mypp2008-FY08-2007\$Actual	AD200812-MYPP2008-FY09-2007\$Actual	AD200812-MYPP2008-FY10-2007\$Actual	AD200812-MYPP2008-FY11-2007\$Actual	AD200812-MYPP2008-FY12-2007\$Actual

[†] SOT: State of Technology [‡] EIA, "Annual Energy Outlook 2009", Table 112, U.S., http://www.eia.doe.gov/oiaf/archive/aeo09/supplement/suptab_112.xls

* 0.67 gallon gasoline/gallon ethanol conversion factor

Note: MS Excel™ when asked to round numbers, presents the rounded numbers in the table, however, upon executing calculations the software utilizes the exact number without rounding in each individual cell. This difference in how the numbers are rounded and added can lead to \$0.01 difference between the summations of the cell contents and the summations of the cell displays.

Table B-6: Unit Operation Cost Contribution Estimates (2007\$) and Technical Projections for Thermochemical Conversion to Gasoline and Diesel Baseline Process Concept²

(Process Concept: Woody Energy Crop, Fast Pyrolysis, Bio-oil Upgrading, Fuel Finishing)

Processing Area Cost Contributions & Key Technical Parameters	Metric	2009 SOT	2010 Projection	2011 Projection	2012 Projection	2013 Projection*	2014 Projection	2015 Projection	2016 Projection	2017 Projection [†]
Conversion Contribution	\$/gal gasoline	\$6.30	\$4.92	\$3.99	\$3.51	\$2.82	\$2.41	\$2.26	\$1.81	\$1.56
	\$/gal diesel	\$6.37	\$4.99	\$4.06	\$3.57	\$2.90	\$2.48	\$2.33	\$1.88	\$1.56
Conversion Contribution, combined fuel	\$/gge	\$6.02	\$4.71	\$3.83	\$3.38	\$2.71	\$2.32	\$2.19	\$1.75	\$1.47
Year \$ basis		2007	2007	2007	2007	2007	2007	2007	2007	2007
2017 Program Target Derived from EIA Reference Case [†]	\$/gal gasoline									\$2.85
Minimum Gasoline Selling Price	\$/gal gasoline	\$7.10	\$5.67	\$4.70	\$4.20	\$3.42	\$3.01	\$2.82	\$2.32	\$2.15
Minimum Diesel Selling Price	\$/gal diesel	\$7.18	\$5.74	\$4.77	\$4.27	\$3.50	\$3.08	\$2.89	\$2.40	\$2.15
Production Gasoline + Diesel	mm gallons/yr	53	53	53	53	61	61	66	70	76
Yield (Gasoline + Diesel)	gal/ dry ton wood	73	73	73	73	84	84	91	98	106
Natural Gas Consumption	SCF/dry ton wood	1,840	1,840	1,650	1,650	3,820	3,820	4,140	4,450	4,430
Feedstock										
Total Cost Contribution	\$/gal total fuel	\$0.80	\$0.75	\$0.71	\$0.70	\$0.60	\$0.60	\$0.56	\$0.52	\$0.58
Capital Cost Contribution	\$/gal total fuel	\$0.00	\$0.00	\$0.00	\$0.00	\$0.00	\$0.00	\$0.00	\$0.00	\$0.00
Operating Cost Contribution	\$/gal total fuel	\$0.80	\$0.75	\$0.71	\$0.70	\$0.60	\$0.60	\$0.56	\$0.52	\$0.58
Feedstock Cost	\$/dry US ton	\$58.20	\$54.20	\$51.80	\$50.70	\$50.70	\$50.70	\$50.70	\$50.70	\$61.20
Energy Content (LHV, dry basis)	BTU/lb	7603	7603	7603	7603	7603	7603	7603	7603	7603
Feed Handling, Drying, Fast Pyrolysis										
Total Cost Contribution	\$/gal total fuel	\$0.54	\$0.53	\$0.52	\$0.52	\$0.45	\$0.44	\$0.41	\$0.38	\$0.34
Capital Cost Contribution	\$/gal total fuel	\$0.33	\$0.32	\$0.32	\$0.31	\$0.27	\$0.27	\$0.25	\$0.23	\$0.21
Operating Cost Contribution	\$/gal total fuel	\$0.21	\$0.21	\$0.20	\$0.20	\$0.18	\$0.18	\$0.16	\$0.15	\$0.13
Feed Moisture Content to FP	%	7%	7%	7%	7%	7%	7%	7%	7%	7%
Number Fast Pyrolysis Units		1x2000 tpd no filter	1x2000 tpd no filter	1x2000 tpd w filter	1x2000 tpd w filter	1x2000 tpd w filter	1x2000 tpd w filter	1x2000 tpd w filter	1x2000 tpd w filter	1x2000 tpd w filter
Pyrolysis Oil Yield (dry)	lb/lb dry wood	0.60	0.60	0.60	0.60	0.62	0.62	0.63	0.64	0.65
Ash Content	ppm	<500	<500	<500	<500	<500	<500	<500	<500	<500
Char	ppm	<500	<500	<500	<500	<500	<500	<500	<500	<500

Appendix B: Technical Projection Tables

Processing Area Cost Contributions & Key Technical Parameters	Metric	2009 SOT	2010 Projection	2011 Projection	2012 Projection	2013 Projection*	2014 Projection	2015 Projection	2016 Projection	2017 Projection [†]
Corrosivity, TBD	TBD	TBD	TBD	TBD	TBD	TBD	TBD	TBD	TBD	TBD
Upgrading to Stable Oil via Multi-Step Hydrodeoxygenation										
Total Cost Contribution	\$/gal total fuel	\$4.69	\$3.34	\$2.48	\$2.01	\$1.33	\$0.92	\$0.85	\$0.46	\$0.47
Capital Cost Contribution	\$/gal total fuel	\$0.46	\$0.45	\$0.42	\$0.41	\$0.35	\$0.34	\$0.32	\$0.19	\$0.19
Operating Cost Contribution	\$/gal total fuel	\$4.23	\$2.89	\$2.06	\$1.60	\$0.97	\$0.57	\$0.53	\$0.27	\$0.28
Number of Parallel Hydrotreaters		2x100% w guard bed	2x100% w guard bed	2x100% no guard bed	2x100% no guard bed	2x100% no guard bed	2x100% no guard bed	2x100% no guard bed	1x100% no guard bed	1x100% no guard bed
Catalyst Life	operating days	14	21	30	40	60	120	120	329	329
Catalyst Regeneration Frequency	days	0	0	0	0	0	0	0	6	1
Catalyst Base		carbon	carbon	carbon	carbon	carbon	carbon	carbon	carbon	carbon
Stable Oil Yield	lb/lb dry FP oil	0.40	0.40	0.40	0.40	0.45	0.45	0.47	0.5	0.55
Corrosivity, TBD	TBD	TBD	TBD	TBD	TBD	TBD	TBD	TBD	TBD	TBD
Sulfur	ppm	<40	<40	<40	<40	<40	<30	<30	<20	<15
Nitrogen	ppm	<40	<40	<40	<40	<40	<40	<40	<40	<40
Chlorine	ppm	<50	<50	<50	<50	<50	<50	<50	<50	<50
Alkali Compounds	ppm	<10	<10	<10	<10	<10	<10	<10	<10	<10
Gasoline, Octane Number		~89	~89	~89	~89	~89	~89	~89	~89	~89
Diesel, Cetane Index		~32	~32	~32	~32	~32	~32	~32	~32	≥40
Hydrogen Partial Pressure Reactor	psia	~1750	~1750	~1600	~1600	~1600	~1600	~1600	~1600	~1600
Fuel Finishing to Gasoline and Diesel via Hydrocracking and Distillation										
Total Cost Contribution	\$/gal total fuel	\$0.30	\$0.30	\$0.29	\$0.29	\$0.27	\$0.26	\$0.25	\$0.25	\$0.11
Capital Cost Contribution	\$/gal total fuel	\$0.22	\$0.21	\$0.21	\$0.21	\$0.19	\$0.19	\$0.18	\$0.18	\$0.07
Operating Cost Contribution	\$/gal total fuel	\$0.09	\$0.09	\$0.08	\$0.08	\$0.07	\$0.07	\$0.07	\$0.06	\$0.05
Extent of Hydrocracking/treating		diesel and heavier	diesel and heavier	diesel and heavier	diesel and heavier	diesel and heavier	diesel and heavier	diesel and heavier	diesel and heavier	heavier than diesel
Balance of Plant: Hydrogen Generation										
Total Cost Contribution	\$/gal total fuel	\$0.82	\$0.81	\$0.75	\$0.74	\$0.82	\$0.82	\$0.78	\$0.75	\$0.65
Capital Cost Contribution	\$/gal total fuel	\$0.43	\$0.42	\$0.39	\$0.38	\$0.33	\$0.33	\$0.30	\$0.28	\$0.23
Operating Cost Contribution	\$/gal total fuel	\$0.37	\$0.37	\$0.34	\$0.34	\$0.49	\$0.49	\$0.48	\$0.47	\$0.41
Models: Case References		2009 SOT-1Q10	2010 P-1Q10	2011 P-1Q10	2012 P-1Q10	2013 P-1Q10	2014 P-1Q10	2015 P-1Q10	2016 P-1Q10	2017 Design ³

Note: The table may contain very small (< \$0.01) rounding errors due to the difference between the way that Microsoft Excel™ displays and calculates rounded values.

[‡] EIA, "Annual Energy Outlook 2009" Post ARRA April 2009, Table 112, U.S., http://www.eia.doe.gov/oiat/archive/aeo09/supplement/suptab_112.xls

^{*} The demarcation line between 2012 and 2013 indicates a planned design case update to incorporate findings from the NABC, the stabilization call, and future upgrading work

[†] "Production of Gasoline and Diesel from Biomass Via Fast Pyrolysis, Hydrotreating and Hydrocracking: A Design Case," PNNL-18284, February 2009.

Endnotes

- ¹ Blackwelder, D.B. and E.G. Wilkerson, 2008. 2007 State-of-Technology (SOT) Assessment of Costs of Forest Thinnings. Idaho National Laboratory Technical Memorandum, TM2008-007-0 (INL/MIS-09-15227).
- ² “Production of Gasoline and Diesel from Biomass via Fast Pyrolysis, Hydrotreating and Hydrocracking: A Design Case,” PNNL-18284, February 2009.

Appendix C: Calculation Methodology for Cost Targets

The two primary goals of this Appendix are to:

- 1) summarize the bases for Biomass Program's performance goals and biofuels cost projections
- 2) explain the general methodology used to develop the cost projections and adjust them to different year dollars.

Table C-1 describes the primary documents, including the MYPP, that cover the evolution of technology design and cost projections for a specific biochemical conversion concept. Additional details for the technical performance targets and cost targets can be found in Appendix B.

Table C-1: Primary Source Documents for Program Cost Targets

Document	Design and Cost Information: Bases and Differences
2002 Corn Stover to Ethanol Design Report ¹	<ul style="list-style-type: none"> • Ethanol market target of \$1.07/gal (2000\$) to be competitive with corn ethanol. • First design report for an agricultural residue feedstock. • Assumed \$30/dry ton feedstock cost delivered to the plant in bales. • Detailed conversion plant process design, factored capital cost estimate, operating cost estimate, and discounted cash flow rate of return used to determine ethanol cost target. • Costs based on year 2000\$.
2005 MYPP ² with Feedstock Logistics Estimates	<ul style="list-style-type: none"> • Ethanol cost target of \$1.08/gal (2002\$) in 2020. • First Program plan with feedstock cost components identified. • Feedstock grower payment assumed at \$10/ton, although it is understood that this is a point on the supply curve that would correspond to a relatively low level of available agricultural residue type feedstock. • Feedstock logistics estimated cost at \$25/dry ton based on unit operations breakdown including preprocessing and handling, with equipment and operations up to the pretreatment reactor throat. • Detailed conversion plant design virtually the same as in the 2002 design report, but excluded feedstock handling system equipment and operation, which is now included in feedstock logistics. Several additional minor modifications and corrections made to original design with no significant cost impact. • Conversion costs escalated to 2002\$.
2007 MYPP	<ul style="list-style-type: none"> • Cost target of ~ \$1.30/gal (2007\$) in 2012. • Feedstock grower payment escalated to \$13/ton, although it is still and assumed number and understood that it is a point on the supply curve that would correspond to a relatively low level of available agricultural residue type feedstock. • Feedstock logistics cost breakdown updated based on first detailed design report covering this portion of the supply chain. • Detailed conversion plant design virtually the same as used in the 2005 MYPP case. • All costs escalated to 2007 dollars.

2009 MYPP ³	<ul style="list-style-type: none"> • Program cost target of \$1.76/gal (2007\$) in 2012 is based on Energy Information Administration’s (EIA) reference case wholesale price of motor gasoline for 2012⁴ and calculations to adjust for the energy density of ethanol relative to gasoline.²⁰ Program cost target of \$1.76/gal (2007\$) in 2017 reflects the addition of new feedstocks, new conversion technologies, and new cellulosic biofuels in the Program portfolio. • Cost projection of \$1.49/gal (2007\$) in 2012 for the biochemical conversion platform projected nth plant ethanol cost. • Introduction of first projection of woody feedstock costs. • Feedstock grower payment escalated to \$15.90/ton, although it is still assumed and understood that it is a point on the supply curve that would correspond to a relatively low level of available agricultural residue type feedstock. • Thermochemical conversion model updated based on first detailed design report for gasification, synthesis gas clean up, and mixed alcohol synthesis. • Thermochemical conversion model included based on first design report for pyrolysis, pyrolysis -oil upgrading and stabilization, and fuel synthesis to gasoline/diesel blendstock. • All costs escalated to 2007\$ using actual economic indices up to 2007. • Feedstock models significantly improved and refined which resulted in a price increase.⁵
2010 MYPP	<ul style="list-style-type: none"> • Program performance goals are based on EIA’s reference case wholesale price of motor gasoline. The 2012 goal is based on the EIA’s pre-ARRA reference case for gasoline.⁶ The 2017 goals for gasoline, diesel, and jet are based on the EIA’s post-ARRA reference case.⁷ • Thermochemical conversion models updated based on first detailed design report for pyrolysis to hydrocarbon biofuels.
2011 MYPP	<ul style="list-style-type: none"> • Platform cost target projections held steady for October, 2010 MYPP update. • Thermochemical conversion models further detailed for pyrolysis to hydrocarbon fuels.

Program’s Cost Target (Performance Goal): Calculation Methodology

Historically, the Program’s performance cost targets have been based on NREL-specific processing pathways using literature, bench, and some pilot-scale data. As the program moves forward and funds large-scale projects, the overall program performance goals needs to be broad enough to encompass all funded technologies. For any process to be economically viable, it must be cost competitive with petroleum-based fuels.

Beginning FY 2009, the Program’s performance goals have been based on cost competitiveness with petroleum-based fuels, specifically EIA’s oil price outlook for future motor gasoline, diesel, and jet wholesale prices. The underlying assumptions include the following:

- Refinery gate production cost of gasoline can be compared to the biorefinery production cost of ethanol (adjusted for Btu content) and other biofuels.
- Downstream distribution costs are excluded as are subsidies and tax incentives.

The historical wholesale motor gasoline prices and EIA projections are presented in Figure C-1.

²⁰ 0.67 gallon gasoline /gallon ethanol conversion factor

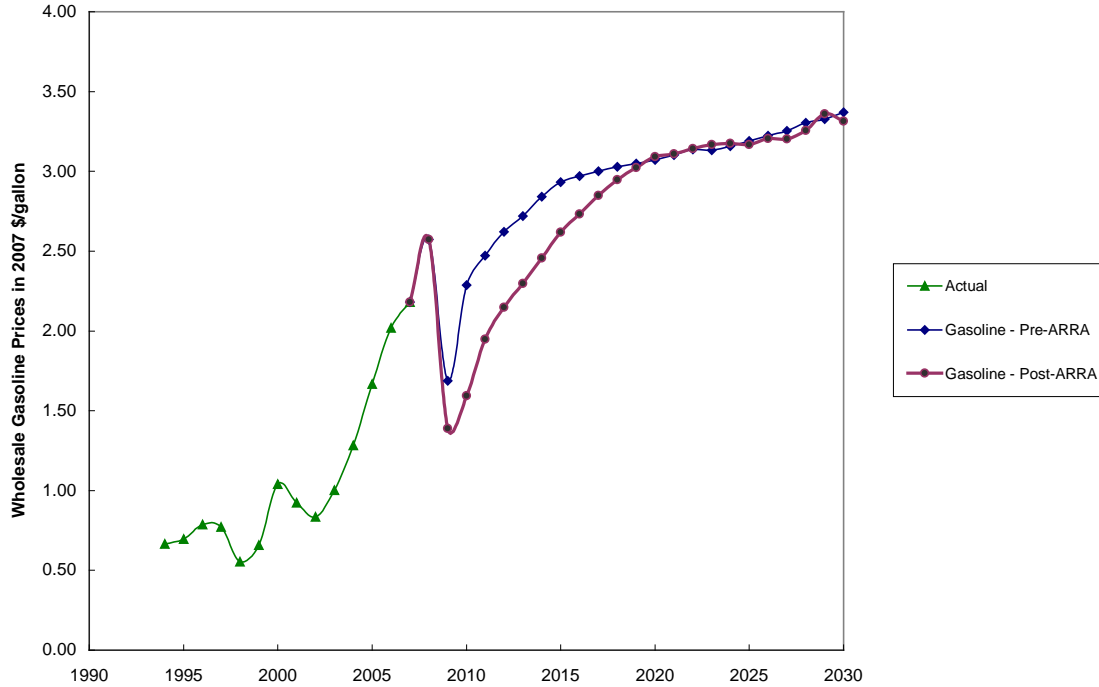

Figure C-1: EIA’s Projection for Wholesale Motor Gasoline Prices

The oil price, gasoline wholesale price, diesel wholesale price, and jet wholesale price for EIA’s pre- and post-ARRA reference cases are summarized in Table C-2.

Table C-2. Oil Price Forecasts for 2012⁸ and 2017⁹

EIA Scenario	Oil Price Forecast (2007\$/barrel)	Wholesale Price (2007\$/gallon)
2012		
EIA, AEO2009, Pre-ARRA - Gasoline Reference Case 2012	94.84	2.62
2017		
EIA, AEO2009, Post-ARRA – Gasoline Reference Case 2017	108.38	2.85
EIA, AEO2009, Post-ARRA - Diesel Reference Case 2017		2.84
EIA, AEO2009, Post-ARRA - Jet Reference Case 2017		2.76

The Biomass Program’s 2012 performance goal is based on the 2012 reference oil price case. The 2017 goals are based on post-ARRA projections and assume that by 2017, significant impact will be realized from ARRA funding.

Cost Projections

Table C-3 shows the cost breakdown of the projected cost targets for the first four cases described in Table C-1, based on the first three major elements of the biomass-to-biofuels supply chain (feedstock production, feedstock logistics, and biomass conversion) and their associated sub-elements. It is important to note that in this example for producing ethanol from corn stover using a biochemical conversion process, the ethanol yields for each of the four cases are nearly identical. This is an indication that the technical aspects of the targeted performance for the biomass conversion element are not changing between the cases.

Table C-3: Production Cost Projection Breakdown by Supply Chain Element

Supply Chain Areas	Units	2002 Corn Stover- to- Ethanol Design Report	2005 MYPP with Feedstock Logistics Estimates	2007 MYPP - 2012 Target	2009 MYPP - 2012 Projection
Year \$s	Year	2000	2002	2007	2007
Feedstock Production					
Grower Payment	\$/dry Ton	\$10.00	\$10.00	\$13.10	\$15.90
Feedstock Logistics					
Harvest and Collection	\$/dry ton		\$12.50	\$10.60	\$12.15
Storage and Queuing	\$/dry ton		\$1.75	\$3.70	\$5.95
Preprocessing	\$/dry ton		\$2.75	\$6.20	\$10.74
Transportation and Handling	\$/dry ton		\$8.00	\$12.30	\$6.16
Logistics Subtotal	\$/dry ton	\$20.00	\$25.00	\$32.80	\$35.00
Feedstock Total	\$/dry ton	\$30.00	\$35.00	\$45.90	\$50.90
Ethanol Yield	gal EtOH/ dry ton	89.7	89.8	89.8	89.9
Feedstock Production					
Grower Payment	\$/gal EtOH	\$0.11	\$0.11	\$0.15	\$0.18
Feedstock Logistics					
Harvest and Collection	\$/gal EtOH		\$0.14	\$0.12	\$0.14
Storage and Queuing	\$/gal EtOH		\$0.02	\$0.04	\$0.07
Preprocessing	\$/gal EtOH		\$0.03	\$0.07	\$0.12
Transportation and Handling	\$/gal EtOH		\$0.09	\$0.14	\$0.07
Logistics Subtotal	\$/gal EtOH	\$0.22	\$0.28	\$0.37	\$0.39
Feedstock Total	\$/gal EtOH	\$0.33	\$0.39	\$0.51	\$0.57
Biomass Conversion					
Feedstock Handling	\$/gal EtOH	\$0.06	\$0.00	\$0.00	\$0.00
Prehydrolysis/ treatment	\$/gal EtOH	\$0.20	\$0.21	\$0.25	\$0.26
Enzymes	\$/gal EtOH	\$0.10	\$0.10	\$0.10	\$0.12
Saccharification & Fermentation	\$/gal EtOH	\$0.09	\$0.09	\$0.10	\$0.12
Distillation & Solids Recovery	\$/gal EtOH	\$0.13	\$0.13	\$0.15	\$0.16
Balance of Plant	\$/gal EtOH	\$0.16	\$0.17	\$0.22	\$0.26
Conversion Total	\$/gal EtOH	\$0.74	\$0.69	\$0.82	\$0.92
Ethanol Production Total	\$/gal EtOH	\$1.07	\$1.08	\$1.33	\$1.49

For this particular design case for ethanol production, the major difference between the 2002 design report and the 2005 MYPP is where some of the feedstock processing and handling costs reside, even though the overall costs do not change dramatically. The primary difference between the 2005 and 2007 costs stem from changing from 2002\$ to 2007\$. It is important to note that the cost for feedstock production is just an assumed value for all the cases. The Program is in the process of developing feedstock supply curves for the different feedstock types identified in the Billion Ton Study. This information is crucial to understanding the range of feedstock costs to be expected as the biomass industry evolves.

The projected production cost targets represent mature technology processing costs, which means that the capital and operating costs are assumed to be for an “nth plant” where several plants have been built and are operating successfully, no longer requiring increased costs for risk financing, longer startups, under performance, and other costs associated with pioneer plants.

General Cost Estimation Methodology

The Program uses consistent, rigorous engineering approaches for developing detailed process designs, simulation models, and cost estimates, which in turn are used to estimate the minimum selling price for a particular biofuel using a standard discounted cash flow rate of return calculation. The feedstock logistics element uses economic approaches to costing developed by the American Society of Agricultural and Biological Engineers. The Program has recently developed a standard analytical protocol, based on industrial chemical engineering approaches, for all its conceptual process design efforts to ensure consistency and comparability of results. Details of the approaches and results of the technical and financial analyses are thoroughly documented in the Program’s conceptual design reports²¹ and are not included here. Instead a high-level general description of how costs are developed and escalated to different year dollars is provided below.

Cost estimate development is slightly different between the feedstock logistics and biomass conversion elements, but generally both elements include capital costs, costs for chemicals and other material, and labor costs. Table C-4 compares the cost indices for these three categories of costs in 2000, 2002, 2007, and 2009 – the years of the cost bases in the cases in Table C-1.

Table C-4: Comparison of Cost Index Values for Plant Capital, Chemicals, and Materials and Labor for 2000, 2002 and 2007

Cost Component	2000 Index	2002 Index	% Change, 2000-2002	2007 Extrapolated Index	% Change, 2002-2007	2007 Index	% Change, 2007-2009
Plant Capital	394.1	395.6	0.4	471.1	19.1	525.4	11.5
Chemicals & Materials	156.7	157.3	0.4	194.1	23.4	203.3	4.7
Labor	17.09	17.97	5.1	20.21	12.5	19.56	3.2

²¹ The three major Program design reports are:

- (1) “Lignocellulosic Biomass to Ethanol Process Design and Economics Utilizing Co-Current Dilute Acid Prehydrolysis and Enzymatic Hydrolysis for Corn Stover,” NREL TP-510-32438, June 2002.
- (2) “Thermochemical Ethanol via Indirect Gasification and Mixed Alcohol Synthesis of Lignocellulosic Biomass,” NREL/TP-510-41168, April 2007.
- (3) “Uniform-Format Solid Feedstock Supply System: A Commodity-Scale Design to Produce an Infrastructure-Compatible Build Solid from Lignocellulosic Biomass,” near final draft on 4/24/09.

The indices for plant capital, and chemicals and materials have increased significantly since 2003, while the labor index has shown a consistent if steady rise of about 2.5% per year. The total project investment (based on total equipment cost), as well as variable and fixed operating costs, are developed first using the best available cost information. Cost information typically comes from a range of years, requiring all cost components to be adjusted to a common year. For the 2007 MYPP case shown in Table C-3 above, each cost component was adjusted based on the ratio of the 2007 index to the actual index for the particular cost component. The delivered feedstock cost was treated as an operating cost for the biomass conversion facility. With these costs, a discounted cash flow analysis of the conversion facility was carried out to determine the selling price of ethanol when the net present value of the project is zero.

Total Project Investment Estimates and Cost Escalation

The Program design reports include detailed equipment lists with sizes and costs, and details on how the purchase costs of all equipment were determined. For the feedstock logistics element, some of the equipment such as harvesters and trucks do not require additional installation cost, however, other logistics equipment and the majority of the conversion facility equipment will be installed.

For the types of conceptual designs the Program carries out, a “factored” approach is used. Once the installed equipment cost has been determined from the purchased cost and the installation factor, it can be indexed to the project year being considered. The purchase cost of each piece of equipment has a year associated with it. The purchased cost year will be indexed to the year of interest using the Chemical Engineering Plant Cost Index.

Figure C-2 and Table C-5 show the historical values of the Index as well as two types of extrapolation. Notice that the index was relatively flat between 2000 and 2002 with less than a 0.4% increase, while there was a nearly 18% jump between 2002 and 2005. Changes in the plant cost indices can drive dramatic increases in equipment costs, which directly impact the total project capital investment. This is illustrated in Table C-3, where the extrapolation to 2007\$ drove a significant increase in the projected ethanol cost target between the 2005 and 2007 MYPPs.

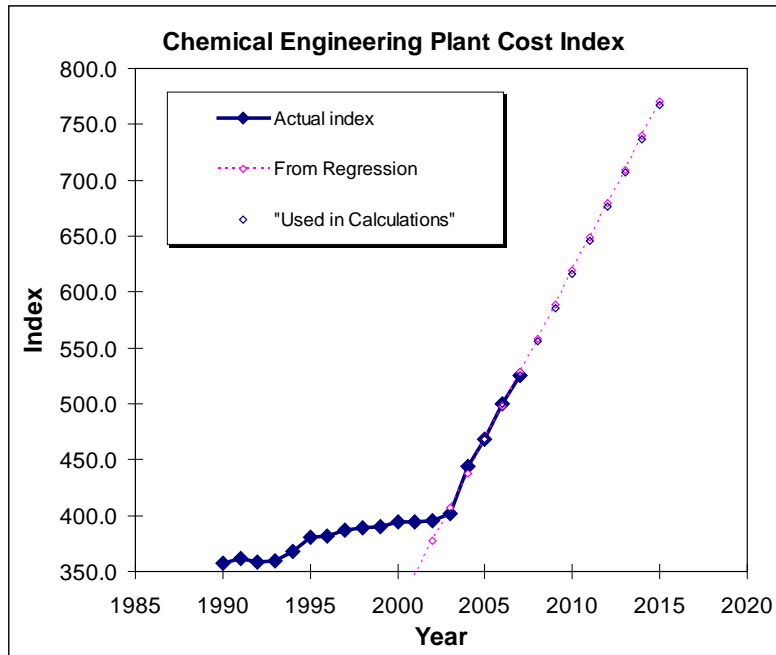

Figure C-2: Actual and Extrapolated Plant Cost Index (see Table C-5 for values)

The extrapolation is dominated by years after 2001 in order to reflect increased globalization of markets with parallel increase in demand for materials in biorefineries. Although there is an economic downturn in 2009, some international markets continue to grow. As additional data points become available, the extrapolation will be refined.

For equipment cost items in which actual cost records do not exist, a representative cost index is used. For example, USDA publishes Prices Paid by Farmers indexes that are updated monthly. These indexes represent the average costs of inputs purchased by farmers and ranchers to produce agricultural commodities and a relative measure of historical costs. For machinery list prices, the Machinery Index was used and for machinery repair and maintenance costs, the Repairs Index was used. These USDA indices were used for all machinery used in the feedstock supply system analysis, including harvest and collection machinery (combines, balers, tractors, etc.), loaders and transportation-related vehicles, grinders, and storage-related equipment and structures.

Operating Cost Estimates and Cost Escalation

For the different design cases, variable operating costs – which include fuel inputs, raw materials, waste handling charges, and byproduct credits – are incurred when the process is operating and are a function of the process throughput rate. All raw material quantities used and wastes produced are determined as part of the detailed material and energy balances calculated for all the process steps. As with capital equipment, the costs for chemicals and materials are associated with a particular year. The U.S. Producer Price Index from SRI Consulting was used as the index for all chemicals and materials. Available data were regressed to a simple equation and used to extrapolate to future years, as shown in Figure C-3 and Table C-6.

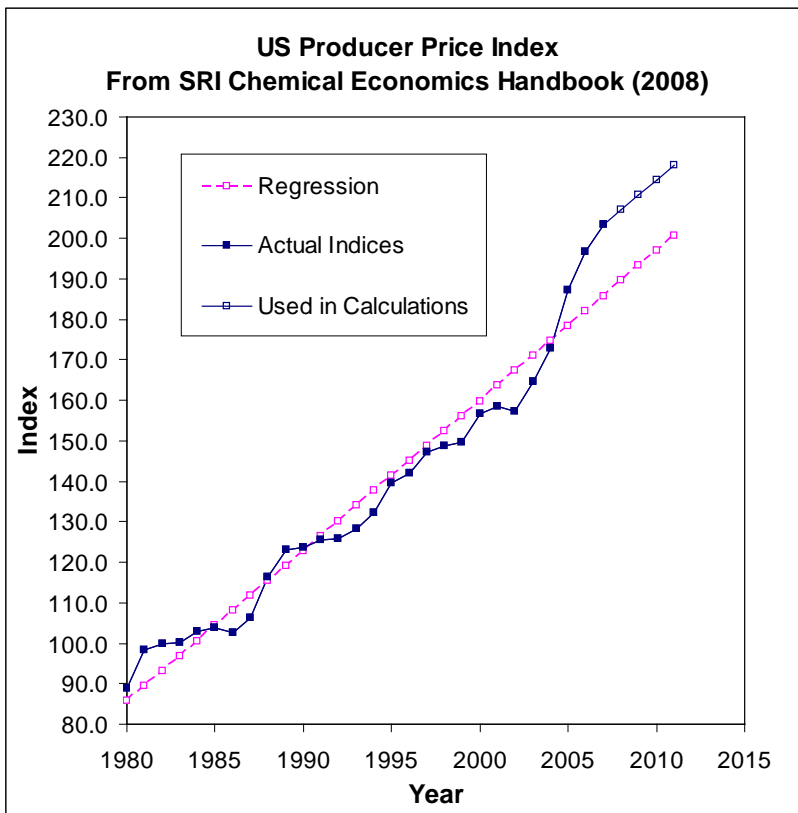

Figure C-3: Actual and Extrapolated Chemical Cost Index (see Table C-6 for values)

Some types of labor, especially related to feedstock production and logistics are variable costs, while labor associated with the conversion facility are considered fixed operating costs.

Fixed operating costs are generally incurred fully whether or not operations are running at full capacity. Various overhead items are considered fixed costs in addition to some types of labor. General overhead is generally a factor applied to the total salaries and covers items such as safety, general engineering, general plant maintenance, payroll overhead (including benefits), plant security, janitorial and similar services, phone, light, heat, and plant communications. Annual maintenance materials are generally estimated as a small percentage (e.g., 2%) of the total installed equipment cost. Insurance and taxes are generally estimated as a small percentage (e.g., 1.5%) of the total installed cost. The index to adjust labor costs is taken from the Bureau of Labor Statistics and is shown in Figure C-4 and Table C-7. The available data were regressed to a simple equation and the resulting regression equation used to extrapolate to future years.

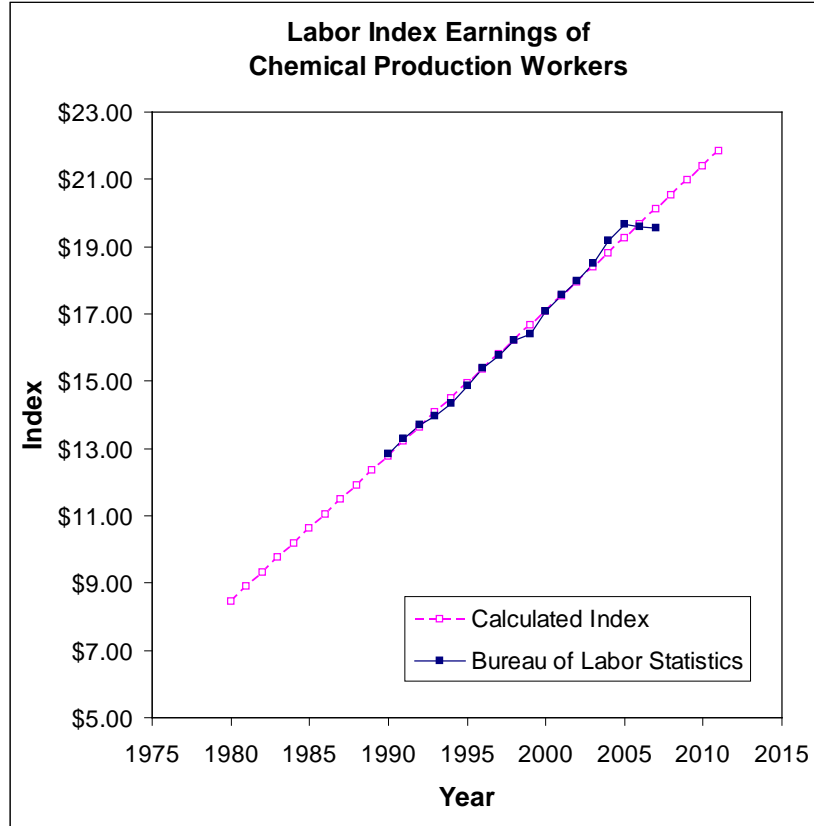

Figure C-4: Actual and Extrapolated Labor Cost Index (see Table C-7 for values)

Discounted Cash Flow Analysis and the Selling Cost of Ethanol

Once the two major cost areas have been determined – (1) total project investment and (2) operating costs – a discounted cash flow analysis can be used to determine the minimum selling price per gallon of biofuel produced. The discounted cash flow analysis program iterates on the selling cost of the biofuel until the net present value of the project is zero. This analysis requires that the discount rate, depreciation method, income tax rates, plant life, and construction start-up duration be specified. The Program has developed a standard set of assumptions for use in the discounted cash flow analysis.

Table C- 5: Plant Cost Indices

Source	Year	CE Annual Index	Calculated Index	Index Used in Calculations
(1)	1990	357.6	14.6	357.6
(1)	1991	361.3	44.8	361.3
(1)	1992	358.2	75.0	358.2
(1)	1993	359.2	105.2	359.2
(1)	1994	368.1	135.5	368.1
(1)	1995	381.1	165.7	381.1
(1)	1996	381.7	195.9	381.7
(2)	1997	386.5	226.1	386.5
(2)	1998	389.5	256.3	389.5
(3)	1999	390.6	286.6	390.6

Appendix C: Calculation Methodology for Cost Targets

Source	Year	CE Annual	Calculated	Index Used in
(4)	2000	394.1	316.8	394.1
(5)	2001	394.3	347.0	394.3
(5)	2002	395.6	377.2	395.6
(6)	2003	402.0	407.4	402.0
(6)	2004	444.2	437.7	444.2
(6)	2005	468.2	467.9	468.2
(7)	2006	499.6	498.1	499.6
(7)	2007	525.4	528.3	525.4
	2008		558.5	555.6
	2009		588.8	585.8
	2010		619.0	616.1
	2011		649.2	646.3
	2012		679.4	676.5
	2013		709.6	706.7
	2014		739.9	736.9
	2015		770.1	767.2

Sources:

- (1) Chemical Engineering Magazine, March, 1997
 - (2) Chemical Engineering Magazine, March, 2000
 - (3) Chemical Engineering Magazine, January, 2001
 - (4) Chemical Engineering Magazine, April, 2002
 - (5) Chemical Engineering Magazine, December, 2003
 - (6) Chemical Engineering Magazine, May 2005
 - (7) Chemical Engineering Magazine, April 2008
- Current indices @ <http://www.che.com/ei>

Table C-6: US Producer Price Index – Total, Chemicals and Allied Products

Year	US Producer Price Index	Calculated Index	Index Used
1980	89.0	85.8	89.0
1981	98.4	89.5	98.4
1982	100.0	93.2	100.0
1983	100.3	96.9	100.3
1984	102.9	100.6	102.9
1985	103.7	104.3	103.7
1986	102.6	108.0	102.6
1987	106.4	111.7	106.4
1988	116.3	115.4	116.3
1989	123.0	119.1	123.0
1990	123.6	122.8	123.6
1991	125.6	126.5	125.6
1992	125.9	130.2	125.9
1993	128.2	133.9	128.2
1994	132.1	137.6	132.1
1995	139.5	141.4	139.5
1996	142.1	145.1	142.1
1997	147.1	148.8	147.1
1998	148.7	152.5	148.7
1999	149.7	156.2	149.7
2000	156.7	159.9	156.7
2001	158.4	163.6	158.4
2002	157.3	167.3	157.3
2003	164.6	171.0	164.6
2004	172.8	174.7	172.8
2005	187.3	178.4	187.3
2006	196.8	182.1	196.8
2007	203.3	185.8	203.3
2008		189.5	207.0
2009		193.2	210.7
2010		196.9	214.4
2011		200.6	218.1

Source:

SRI International Chemical Economics Handbook, Economic Environment of the Chemical Industry 2008

Current indices @ <https://www.sriconsulting.com/CEH/Private/EECI/EECI.pdf>

Table C-7: Labor Index

Year	Reported	Calculated	Index Used
1980		8.46	8.46
1981		8.89	8.89
1982		9.33	9.33
1983		9.76	9.76
1984		10.19	10.19
1985		10.62	10.62
1986		11.05	11.05
1987		11.48	11.48
1988		11.91	11.91
1989		12.34	12.34
1990	12.85	12.78	12.85
1991	13.30	13.21	13.30
1992	13.70	13.64	13.70
1993	13.97	14.07	13.97
1994	14.33	14.50	14.33
1995	14.86	14.93	14.86
1996	15.37	15.36	15.37
1997	15.78	15.79	15.78
1998	16.23	16.22	16.23
1999	16.40	16.66	16.40
2000	17.09	17.09	17.09
2001	17.57	17.52	17.57
2002	17.97	17.95	17.97
2003	18.50	18.38	18.50
2004	19.17	18.81	19.17
2005	19.67	19.24	19.67
2006	19.60	19.67	19.60
2007	19.56	20.10	19.56
2008		20.54	20.54
2009		20.97	20.97
2010		21.40	21.40
2011		21.83	21.83

Source:

Bureau of Labor Statistics, Series ID: CEU3232500006
 Chemicals Average Hourly Earnings of Production Workers
 Current indices from <http://data.bls.gov/cgi-bin/srgate>

Endnotes

- ¹ Lignocellulosic Biomass to Ethanol Process Design and Economics Utilizing Co-Current Dilute Acid Prehydrolysis and Enzymatic Hydrolysis for Corn Stover,” Aden, M. Ruth et al., NREL TP-510-32438, June 2002.
- ² Multi Year Program Plan 2007-2012, Office of the Biomass Program, EERE/DOE, August 31, 2005.
- ³ “Thermochemical Ethanol via Indirect Gasification and Mixed Alcohol Synthesis of Lignocellulosic Biomass,” S. Phillips, A. Aden et al., NREL TP-510-41168.
- ⁴ EIA, “Annual Energy Outlook 2009,” Table 112, U.S.,
http://www.eia.doe.gov/oiaf/archive/aeo09/supplement/suptab_112.xls
- ⁵ EIA, “Annual Energy Outlook 2009”, Table 112, U.S.,
http://www.eia.doe.gov/oiaf/archive/aeo09/supplement/suptab_112.xls
- ⁶ EIA, “Annual Energy Outlook 2009”, Table 112, U.S.,
http://www.eia.doe.gov/oiaf/archive/aeo09/supplement/suptab_112.xls
- ⁷ EIA, “Annual Energy Outlook 2009 Updated Reference Case with ARRA,” Table 112, U.S., April 2009,
http://www.eia.doe.gov/oiaf/aeo/supplement/stimulus/arra/excel/suptab_112.xls
- ⁸ EIA “Annual Energy Outlook 2009,” Reference Case Table 112, U.S. February 2009,
http://www.eia.doe.gov/oiaf/archive/aeo09/supplement/suptab_112.xls
- ⁹ EIA, “Annual Energy Outlook 2009 Updated Reference Case with ARRA,” Table 112, U.S., April 2009,
http://www.eia.doe.gov/oiaf/aeo/supplement/stimulus/arra/excel/suptab_112.xls