



**U.S. Department of Energy**  
**Energy Efficiency**  
**and Renewable Energy**

Bringing you a prosperous future where energy  
is clean, abundant, reliable, and affordable

# **U.S. Department of Energy**

## ***Energy Conservation Program for Consumer Products and Commercial and Industrial Equipment***

### **Energy Conservation Standards Rulemaking for Commercial Refrigeration Equipment**

**Building Technologies Program  
Office of Energy Efficiency and Renewable Energy**

**May 16, 2006**

**[http://www.eere.energy.gov/buildings/appliance\\_standards](http://www.eere.energy.gov/buildings/appliance_standards)**



U.S. Department of Energy  
**Energy Efficiency  
and Renewable Energy**

Bringing you a prosperous future where energy  
is clean, abundant, reliable, and affordable

# Rulemaking Framework for Commercial Refrigeration Equipment

- Ice-Cream Freezers
- Self-Contained Commercial Refrigerators, Freezers, and Refrigerator-Freezers without Doors
- Remote-Condensing Commercial Refrigerators, Freezers, and Refrigerator-Freezers



# Welcome and Introduction

- **Introductions**
- **Agenda**
- **Objectives and Expectations**
- **Role of the Facilitator**
  - **Neutral**
  - **Focus on the process and the task at hand**
  - **Ensure everyone participates**
- **Ground Rules (norms)**
  - **Listen as an ally**
  - **Use short, succinct statements/keep to the point**
  - **Hold sidebar conversations outside the room**
  - **Focus on issues, not personalities**
  - **One person speak at a time (raise hand to be recognized; state your name for the record)**
  - **Turn down the volume on cell phones or place them on “stun”**
- **Housekeeping Items**
  - **Break times**
  - **Cafeteria/Snack bar**
  - **Restrooms**
  - **Public telephones**
  - **No smoking**
  - **Creating a transcript for the record (obtain a copy from the Court Reporter)**



## Public Meeting Agenda

- 1 Introduction
- 2 Rulemaking Overview
- 3 ANOPR Analyses
- 4 NOPR Analyses
- 5 Final Rule Analyses
- 6 Closing Remarks



# Public Meeting Agenda

- 1** Introduction
- 2 Rulemaking Overview
- 3 ANOPR Analyses
- 4 NOPR Analyses
- 5 Final Rule Analyses
- 6 Closing Remarks



## Purpose of the Framework Public Meeting

- Present the procedural and analytical approaches the U.S. Department of Energy (DOE or the Department) anticipates using to evaluate energy conservation standards for:
  - Ice-Cream Freezers
  - Self-Contained Commercial Refrigerators, Freezers, and Refrigerator-Freezers without Doors
  - Remote-Condensing Commercial Refrigerators, Freezers, and Refrigerator-Freezers
- Encourage stakeholders to submit data, information, and written comments
- Inform stakeholders and facilitate the rulemaking process



## Background

- **The Energy Policy Act of 2005 (EPACT 2005)**
  - Section 136(a)(3) defines the terms applicable to commercial refrigeration equipment.
  - Section 136(c)(1) directs DOE to issue by rule, no later than **January 1, 2009**, energy conservation standards effective for equipment manufactured on or after **January 1, 2012**.
  - Section 136(f)(1)(B) directs DOE to determine test procedures and issue, by rule, appropriate rating temperatures.
- **Federal Register - 71 FR 23876 (April 25, 2006)**
  - Gives official public notice of the public meeting and availability of the Framework Document
  - Initiates information and data collection process
  - Encourages interested parties to submit comments
- **Framework Document**
  - Explains issues, analyses, and the process that DOE is considering to develop energy conservation standards for commercial refrigeration equipment
  - Solicits data and information, and invites comments
  - A copy of the Framework Document is available at
  - [http://www.eere.energy.gov/buildings/appliance\\_standards](http://www.eere.energy.gov/buildings/appliance_standards)





## How to Submit Written Comments

- In all correspondence, please refer to the Commercial Refrigeration Rulemaking by
  - **Docket Number EERE-2006-STD-0126, or**
  - **Regulatory Identification Number (RIN) 1904-AB59.**
  
- **Email:**                    [commercialrefrigeration.rulemaking@ee.doe.gov](mailto:commercialrefrigeration.rulemaking@ee.doe.gov)
  
- **Postal Mail:**        **Ms. Brenda Edwards-Jones**  
                                  **U.S. Department of Energy**  
                                  **Building Technologies Program, Mail Stop EE-2J**  
                                  **Commercial Refrigeration Rulemaking, RIN 1904-AB59**  
                                  **1000 Independence Avenue, SW**  
                                  **Washington, DC 20585-0121**
  
- **Courier:**                **Ms. Brenda Edwards-Jones**  
                                  **U.S. Department of Energy**  
                                  **Building Technologies Program, Room 1J-018**  
                                  **Commercial Refrigeration Rulemaking, RIN 1904-AB59**  
                                  **1000 Independence Avenue, SW**  
                                  **Washington, DC 20585-0121**
  
- **Comment period closes **May 30, 2006.****



## Public Meeting Agenda

1	Introduction
2	<b>Rulemaking Overview</b>
3	ANOPR Analyses
4	NOPR Analyses
5	Final Rule Analyses
6	Closing Remarks



## Stages of the Rulemaking Process

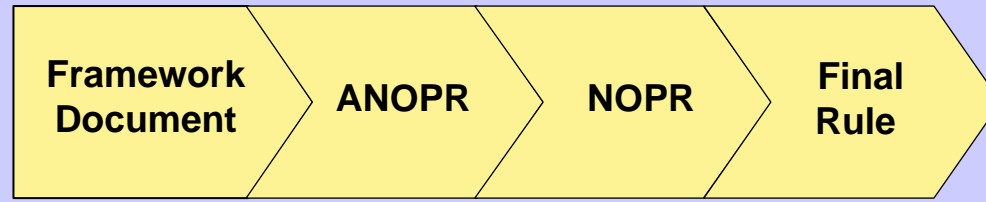

  
Federal Register notices

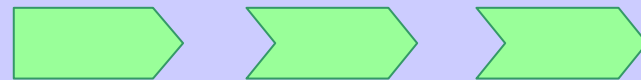

Stakeholder participation

- Public Meetings
- Technical support document
- Written comments on Federal Register notices and Technical Support Documents
- Public meetings and oral comments
- Consultative meetings



## Framework Document

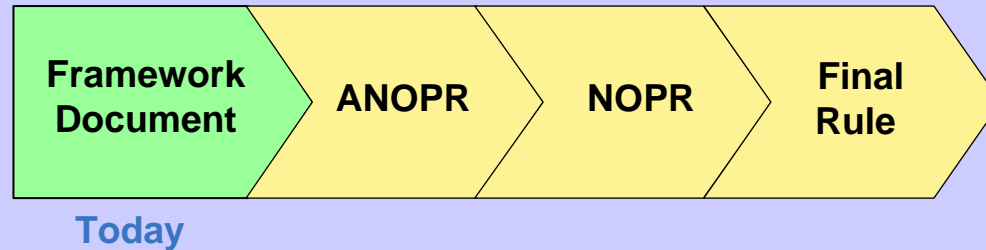

- Today's public meeting covers the Framework Document for this rulemaking.
- The Framework Document provides an overview of the rulemaking process and encourages early stakeholder participation.
- The Department encourages all stakeholders to read the Framework Document, available at:  
[http://www.eere.energy.gov/buildings/appliance\\_standards/](http://www.eere.energy.gov/buildings/appliance_standards/)



## Analyses for Advance Notice of Proposed Rulemaking (ANOPR)

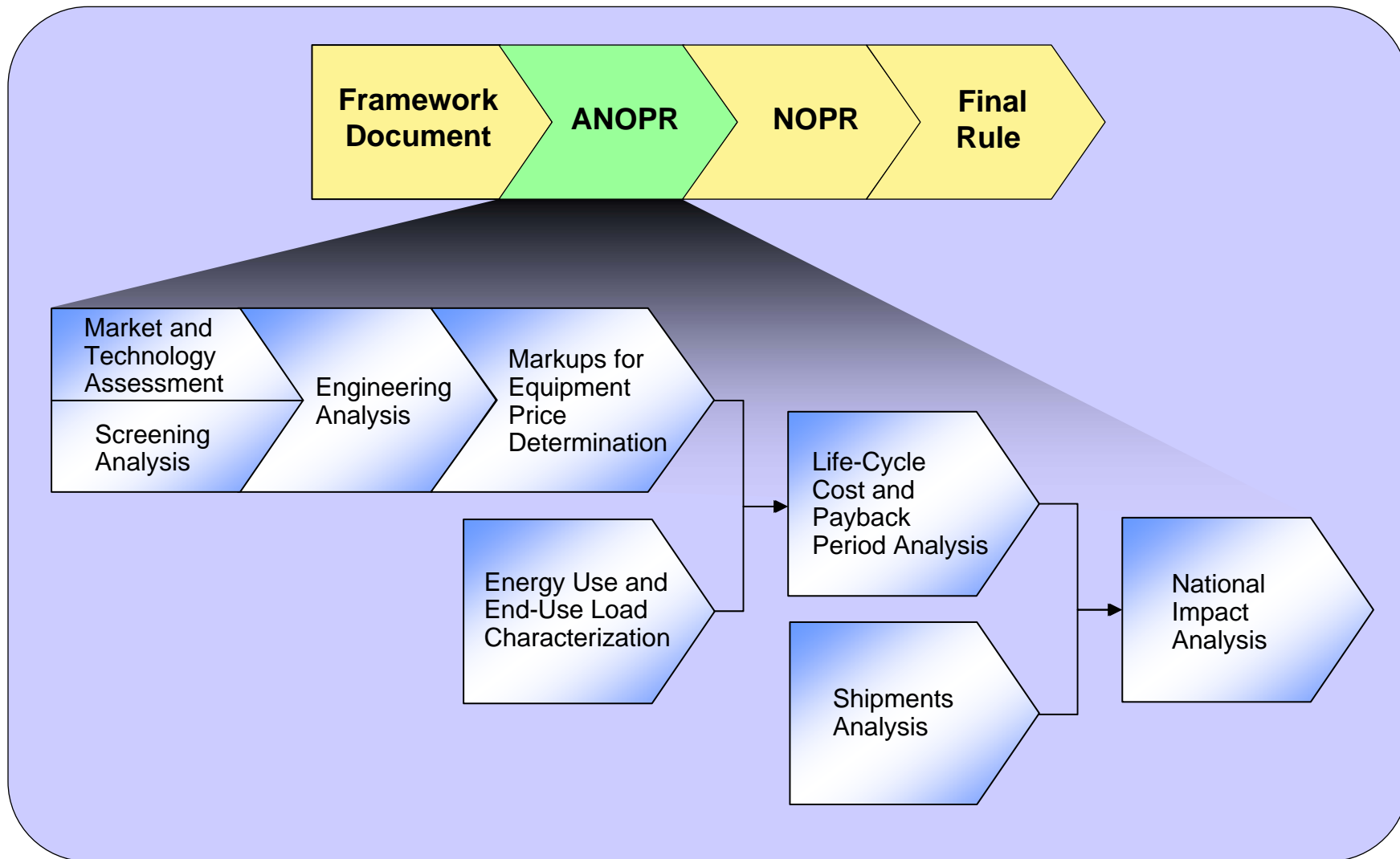



# Analyses for Notice of Proposed Rulemaking (NOPR)

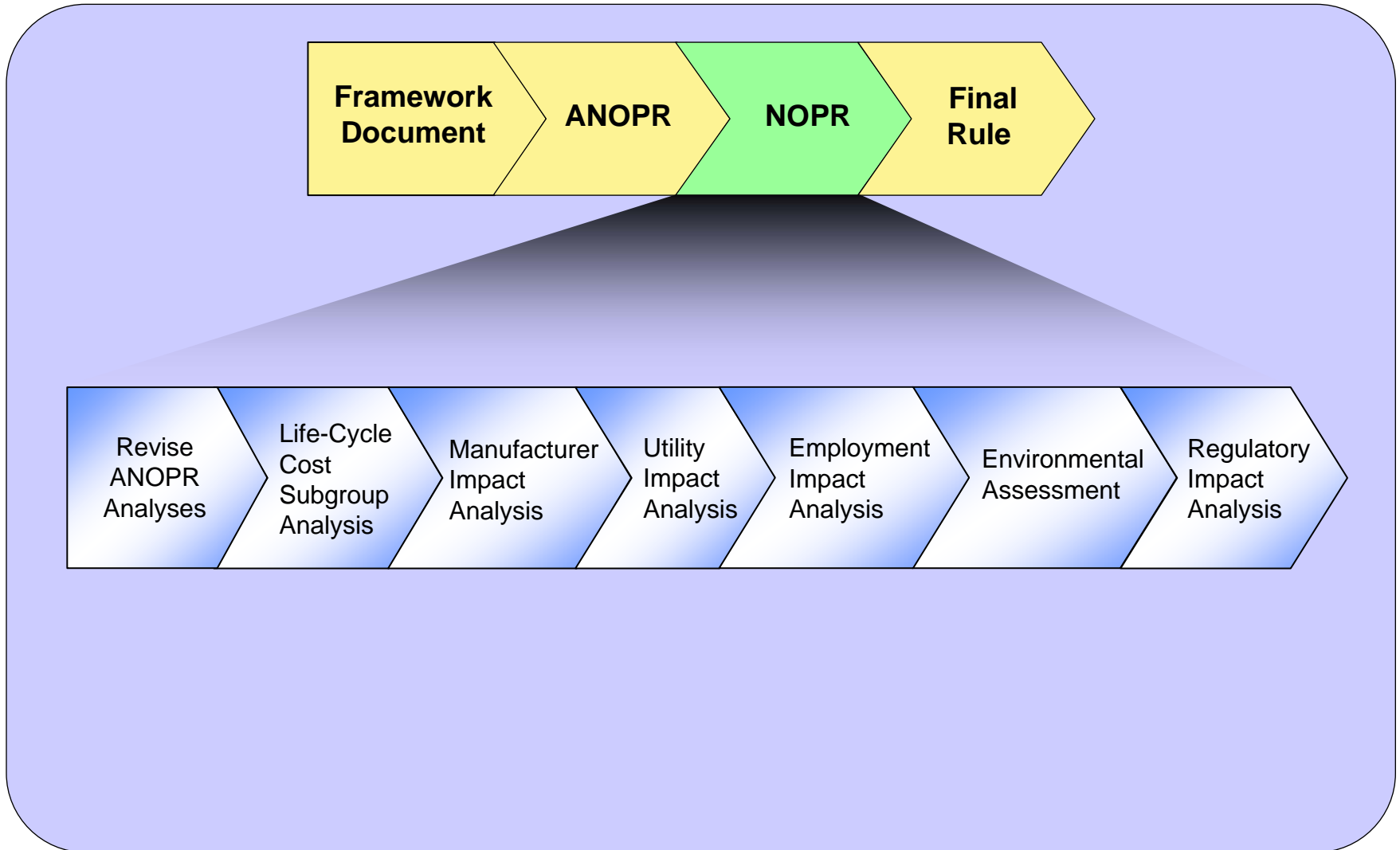



## Analyses for Final Rule

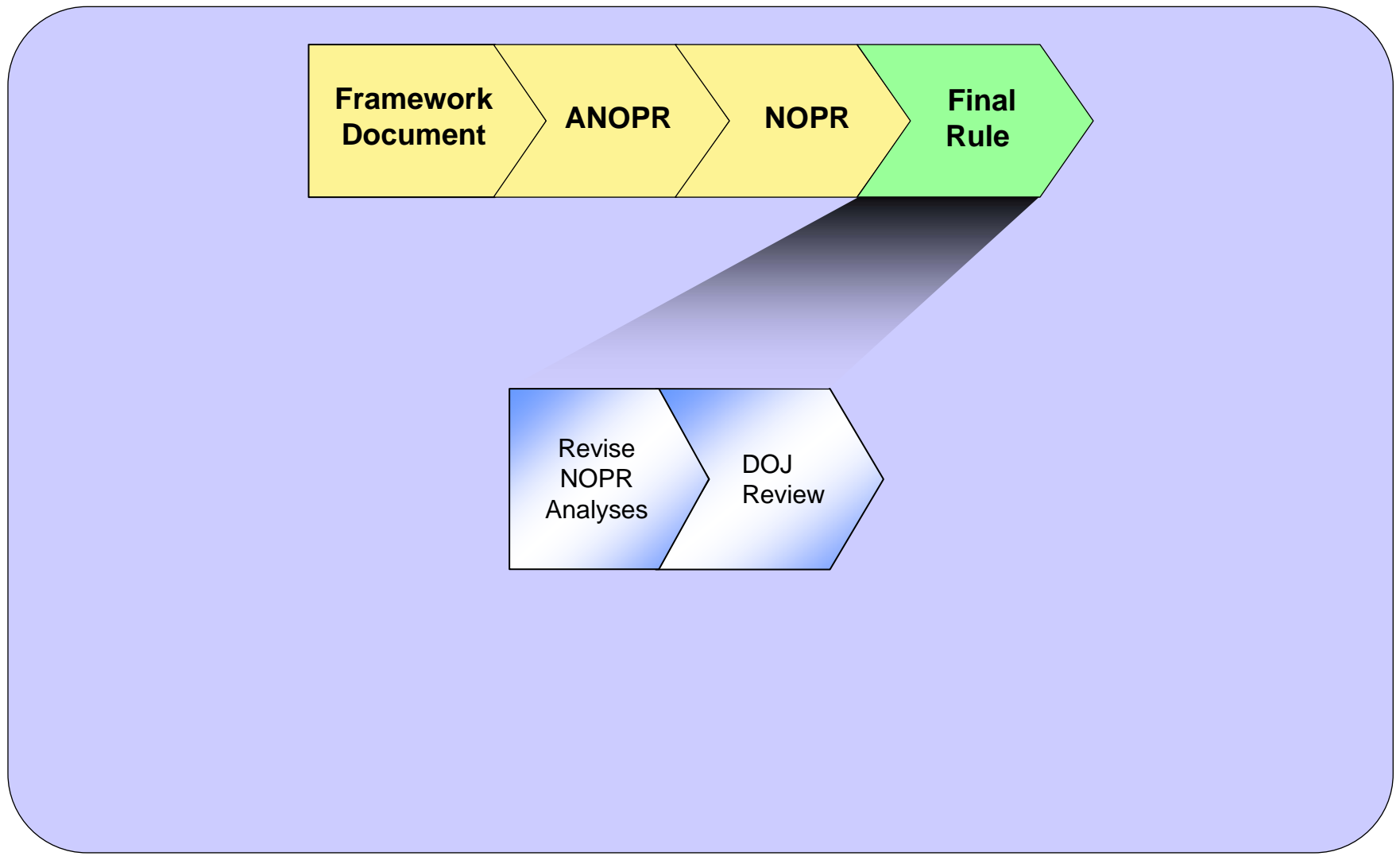



### Test Procedures

- The Department is developing test procedures and rating temperatures for equipment covered under this rulemaking, as mandated by EPACT 2005, in a separate rulemaking.
- The test procedure under consideration is the Air-Conditioning and Refrigeration Institute Standard 1200-2006.
- The Department will issue the Final Rule in the test procedures rulemaking before it publishes the standards notice of proposed rulemaking (NOPR).

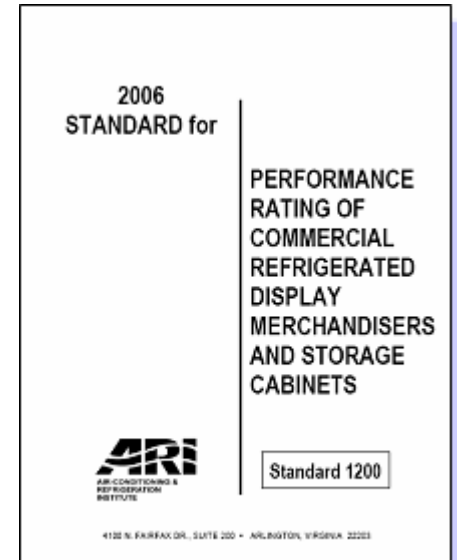



## Commercial Refrigeration Equipment Definition:

- Under section 340(9) of EPCA, 42 U.S.C 6311(9), the term ‘commercial refrigerator, freezer, and refrigerator-freezer’ means refrigeration equipment that—
  - i. is not a consumer product (as defined in section 321 of EPCA);
  - ii. is not designed and marketed exclusively for medical, scientific, or research purposes;
  - iii. operates at a chilled, frozen, combination chilled and frozen, or variable temperature;
  - iv. displays or stores merchandise and other perishable materials horizontally, semi-vertically, or vertically;
  - v. has transparent or solid doors, sliding or hinged doors, a combination of hinged, sliding, transparent, or solid doors, or no doors;
  - vi. is designed for pull-down temperature applications or holding temperature applications; and
  - vii. is connected to a self-contained condensing unit or to a remote condensing unit.



## Secondary Coolant Applications

- The Department construes the language in item (vii) of the above EPACKT 2005 definition to mean that so-called “secondary-coolant applications” are not covered under this rulemaking
- This interpretation is consistent with ARI Standard 1200-2006, which explicitly excludes secondary-coolant applications

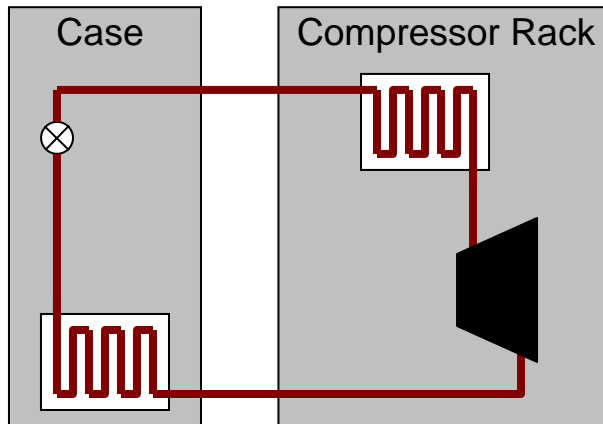

Direct Remote-Condensing System

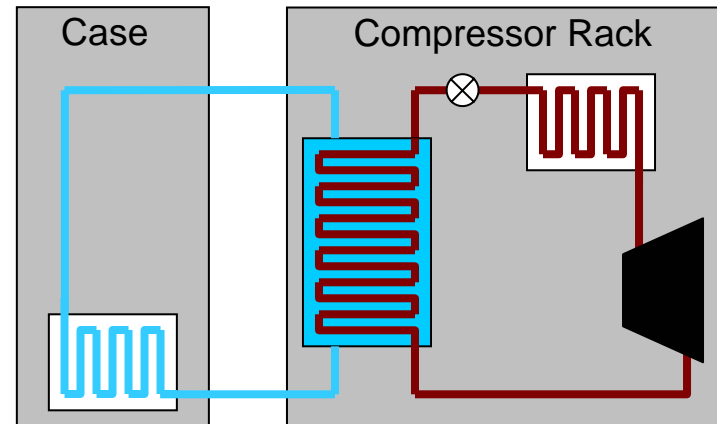

Secondary-Coolant Remote-Condensing System

**Item 1-1** The Department seeks comment on whether secondary-coolant applications should be covered under this rulemaking.



## Ice-Cream Freezers

- Based on an initial review of existing definitions, DOE is considering the following definition:

“The term ‘ice-cream freezer’ means a commercial freezer that is designed to operate at or below -5°F (-21°C) and that the manufacturer designs, markets, or intends for the storing, displaying, or dispensing of ice cream.”



**Item 1-2** The Department is not aware of any industry-standard test methods for ice-cream dipping-cabinets or soft-serve ice-cream extruders. The Department requests information on what, if any, test methods exist for these types of equipment. The Department seeks comment on how it should address these types of equipment in this rulemaking. Should soft-serve ice-cream extruders and ice-cream dipping-cabinets be considered “ice-cream freezers”?

**Item 1-3** The Department seeks comment on the definition of “ice-cream freezer.”

**Item 1-4** In what way are ice-cream freezers different from commercial freezers? The Department requests feedback on whether it should establish energy conservation standards for ice-cream freezers that are different and apart from other commercial freezers.

**Item 1-5** The Department seeks comment on whether to extend energy conservation standards for self-contained commercial freezers with doors and without doors to ice-cream freezers with doors and without doors, respectively.



## Self-Contained Commercial Refrigeration Equipment

- **Without doors is:**
  - connected to a self-contained condensing unit
  - used primarily in grocery and similar retail stores, and in cafeteria-style food service venues for displaying and merchandising food products, including delicatessen items, eggs, meat, produce, seafood, prepared foods, beverages, frozen foods, and dairy items
- EPACT 2005 does not specify a definition for “commercial refrigerator-freezer.”
- The term “electric refrigerator-freezer” is defined for residential products in the Code of Federal Regulations (10 CFR section 430.2) as:
  - “ ... a cabinet which consists of two or more compartments with at least one of the compartments designed for the refrigerated storage of food at temperatures above 32°F. and with at least one of the compartments designed for the freezing and storage of food at temperatures below 8°F which may be adjusted by the user to a temperature of 0°F or below. The source of refrigeration requires single phase, alternating current electric energy input only.”



**Item 1-6** What, if any, self-contained commercial refrigeration equipment without doors does not meet the EPACT 2005 definition?

**Item 1-7** How could this definition be modified to be applicable to self-contained commercial refrigerator-freezers without doors?



## Remote-Condensing Commercial Refrigeration Equipment

- **With and without doors** is:
  - connected to a remote condensing unit
  - used primarily to display and merchandise supermarket goods
- In addition, remote-condensing equipment **with doors** is used for food storage in commercial locations where food is prepared or served, such as hotels and restaurants.



**Item 1-8** The Department seeks comment on regulating the energy consumption of the refrigerated equipment, but not the associated remote condensing unit for remote condensing commercial refrigerators, freezers, and refrigerator-freezers..

**Item 1-9** What, if any, remote condensing commercial refrigeration equipment does not meet the EPACK 2005 definition?

**Item 1-10** How could the above definition for electric refrigerator-freezer be modified to be applicable to remote condensing commercial refrigerator-freezers?



## Public Meeting Agenda

- 1 Introduction
- 2 Rulemaking Overview
- 3 ANOPR Analyses**
- 4 NOPR Analyses
- 5 Final Rule Analyses
- 6 Closing Remarks



# Analyses for Advance Notice of Proposed Rulemaking

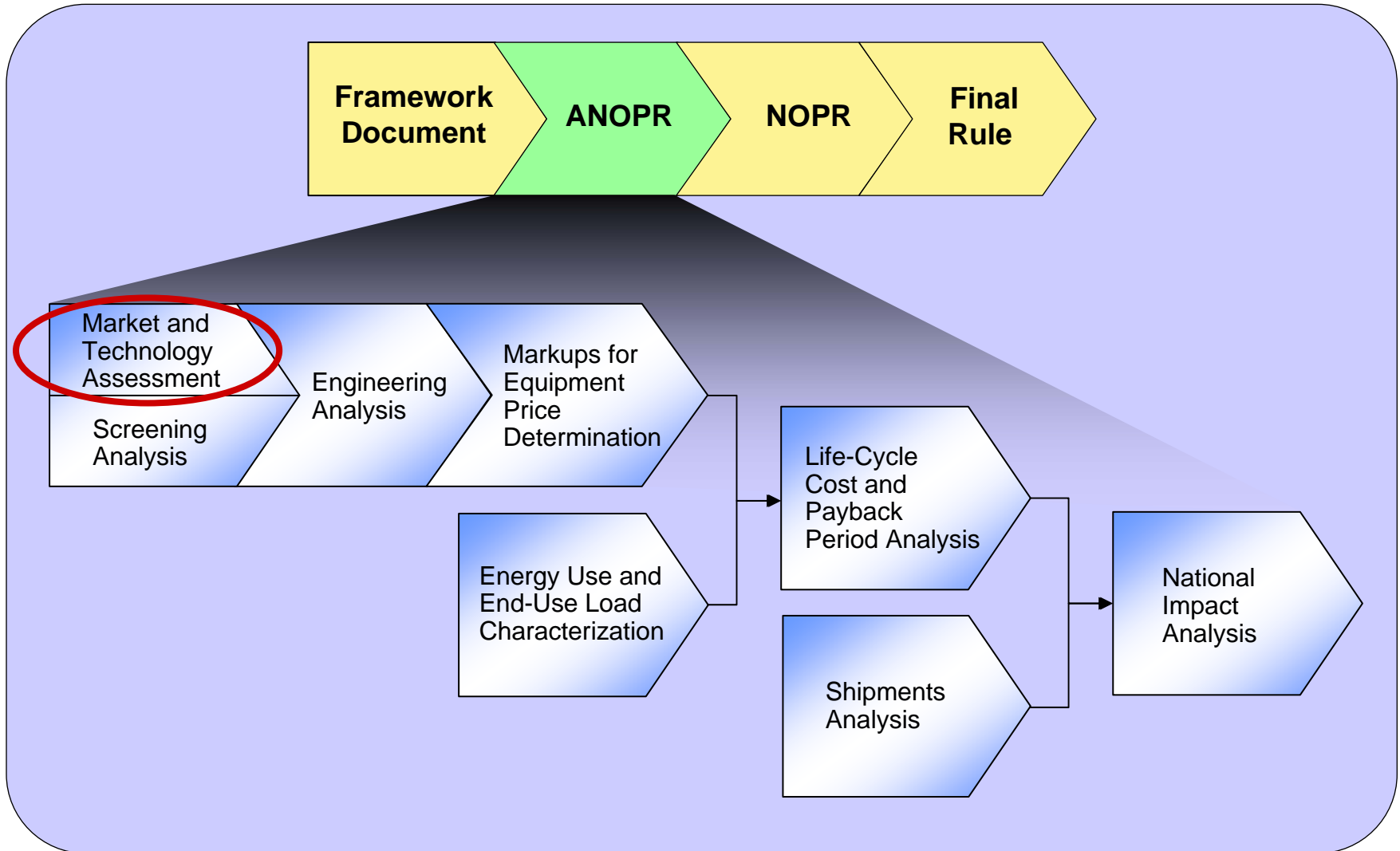



# Relationship of Analyses

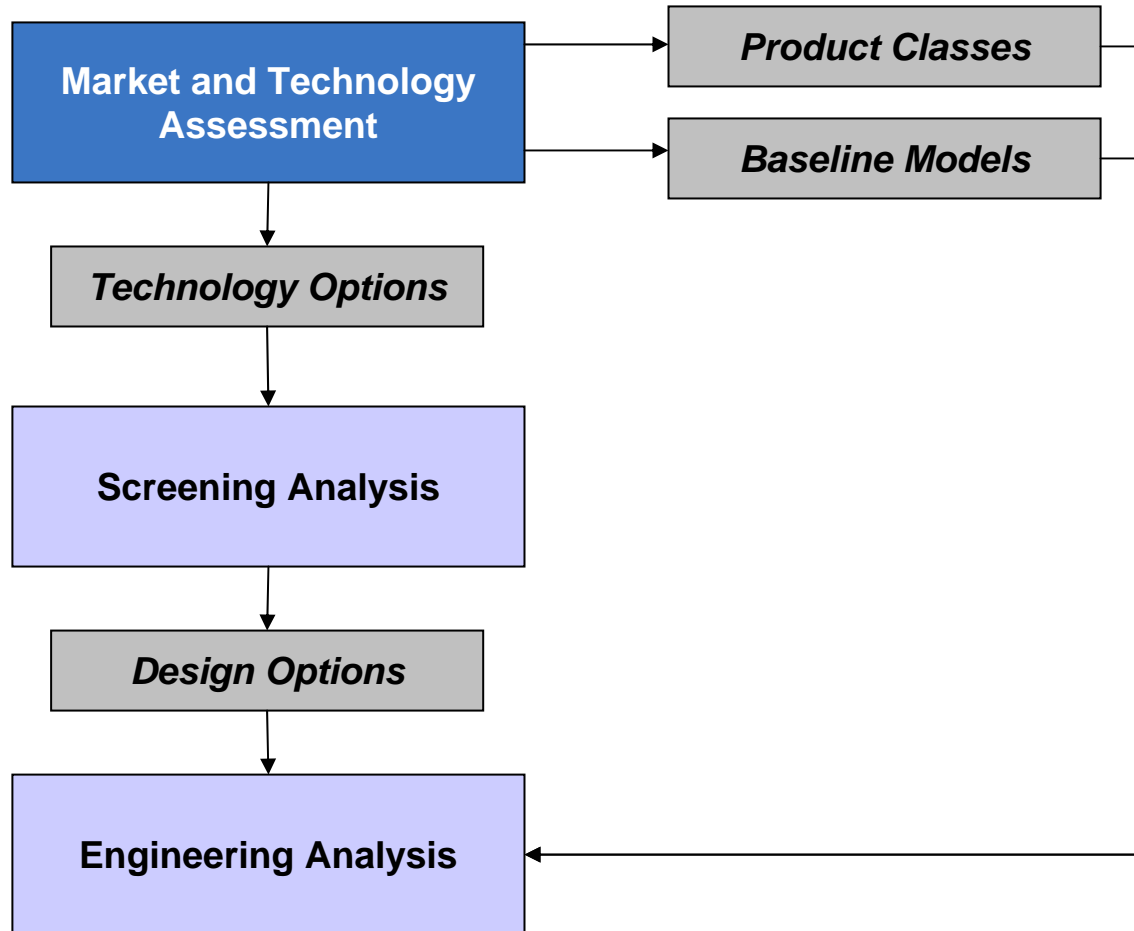



## Purpose

- Characterize the commercial refrigeration industry and market

## Method

- Identify and characterize manufacturers of commercial refrigeration equipment
- Estimate market shares and trends in the market
- Identify technologies that could be applied to commercial refrigeration equipment
- Identify regulatory and non-regulatory initiatives intended to improve energy efficiency of the equipment covered under this rulemaking



## Request for Feedback

- The commercial refrigeration equipment covered under this rulemaking has never before been the object of energy-use regulation at the Federal level. Stakeholders are encouraged to submit any available, applicable data.

**Item 3-1** The Department seeks information that would contribute to the market assessment (e.g., the manufacturers of this equipment in the United States and the products they sell, by product class). It is particularly important that the Department be aware of the major and small/niche manufacturers.

**Item 3-2** The Department seeks information on annual product shipments from 1990 to 2005 (both domestic and imports), and the corresponding shipment-weighted average efficiency of these shipments. Additionally, what units of measure are typically used for annual shipments of this equipment (e.g., cases per year, linear-feet per year, square-feet per year (display-area-based), cubic-feet per year (refrigerated-volume-based), etc)?



# Covered Under this Rulemaking:

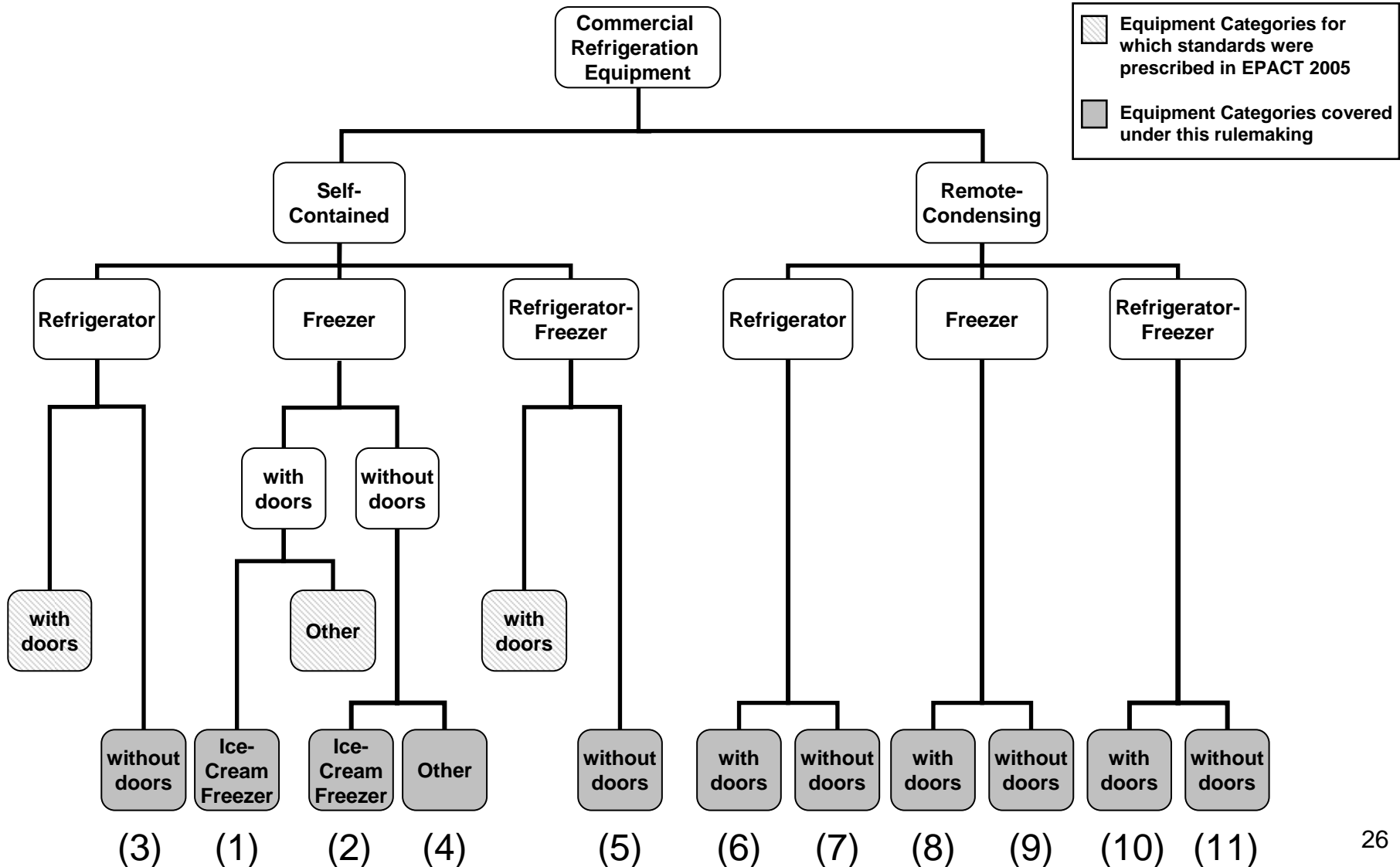



## Proposed Product Classes

- Ice-cream freezers:
  1. Ice-cream freezers with doors [(a) solid doors, (b) transparent doors]
  2. Ice-cream freezers without doors [(a) horizontal, (b) semi-vertical, (c) vertical]
  
- Self-contained equipment without doors:
  3. Self-contained commercial refrigerators without doors [(a) horizontal, (b) semi-vertical, (c) vertical]
  4. Self-contained commercial freezers without doors [(a) horizontal, (b) semi-vertical, (c) vertical]
  5. Self-contained commercial refrigerator-freezers without doors [(a) horizontal, (b) semi-vertical, (c) vertical]
  
- Remote-condensing equipment:
  6. Remote-condensing commercial refrigerators with doors [(a) solid doors, (b) transparent doors]
  7. Remote-condensing commercial refrigerators without doors [(a) horizontal, (b) semi-vertical, (c) vertical]
  8. Remote-condensing commercial freezers with doors [(a) solid doors, (b) transparent doors]
  9. Remote-condensing commercial freezers without doors [(a) horizontal, (b) semi-vertical, (c) vertical]
  10. Remote-condensing commercial refrigerator-freezers with doors [(a) solid doors, (b) transparent doors]
  11. Remote-condensing commercial refrigerator-freezers without doors [(a) horizontal, (b) semi-vertical, (c) vertical]



## Request for Feedback

**Item 3-3** The Department requests feedback on the proposed classes for the commercial refrigeration equipment covered under this rulemaking, and the criteria used in creating the classes.

**Item 3-4** Can the terms “horizontal,” “semi-vertical,” and “vertical” be used to describe equipment orientation? If so, how should these be defined (e.g., based on the angle of the air-curtain or load-line with the vertical, with 0–30° being vertical, 30–60° being semi-vertical, and 60–90° being horizontal)?

**Item 3-5** What product classes, if any, can be combined for standards-setting purposes because of their similarities?

**Item 3-6** Can analyses for any one of these product classes be applied or extrapolated to another product class?

**Item 3-7** Should all of these product classes be considered (e.g., do any of these product classes have few or no shipments)?

**Item 3-8** Would it be appropriate to extend the standards prescribed for self-contained commercial refrigeration equipment with doors in EPACK 2005 to similar remote condensing equipment with doors and ice-cream freezers with doors covered in this rulemaking? If so, what methodology would be appropriate?



## Normalizing Factor in Test Metric

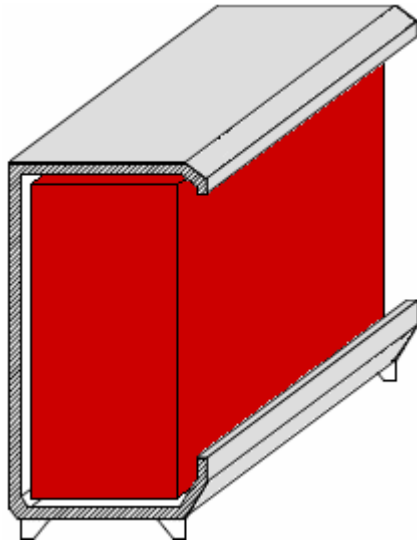

- Refrigerated Volume

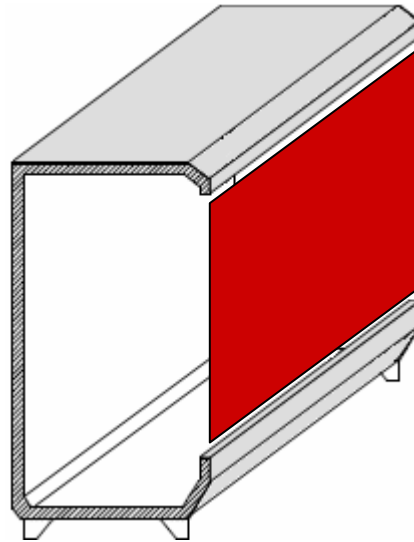

- Total Display Area

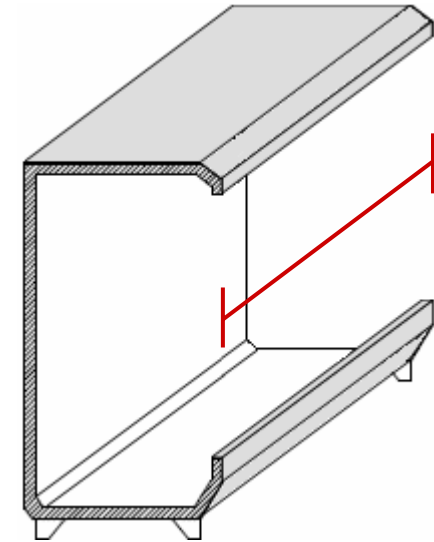

- Length

**Item 3-9** The Department seeks feedback on appropriate test metrics for the commercial refrigeration equipment covered under this rulemaking (e.g., a metric based on volume for equipment with doors and a metric based on case length, total display area, or volume for products without doors).



## Sample of Market Research Data

- Remote-condensing refrigerators without doors, vertical orientation

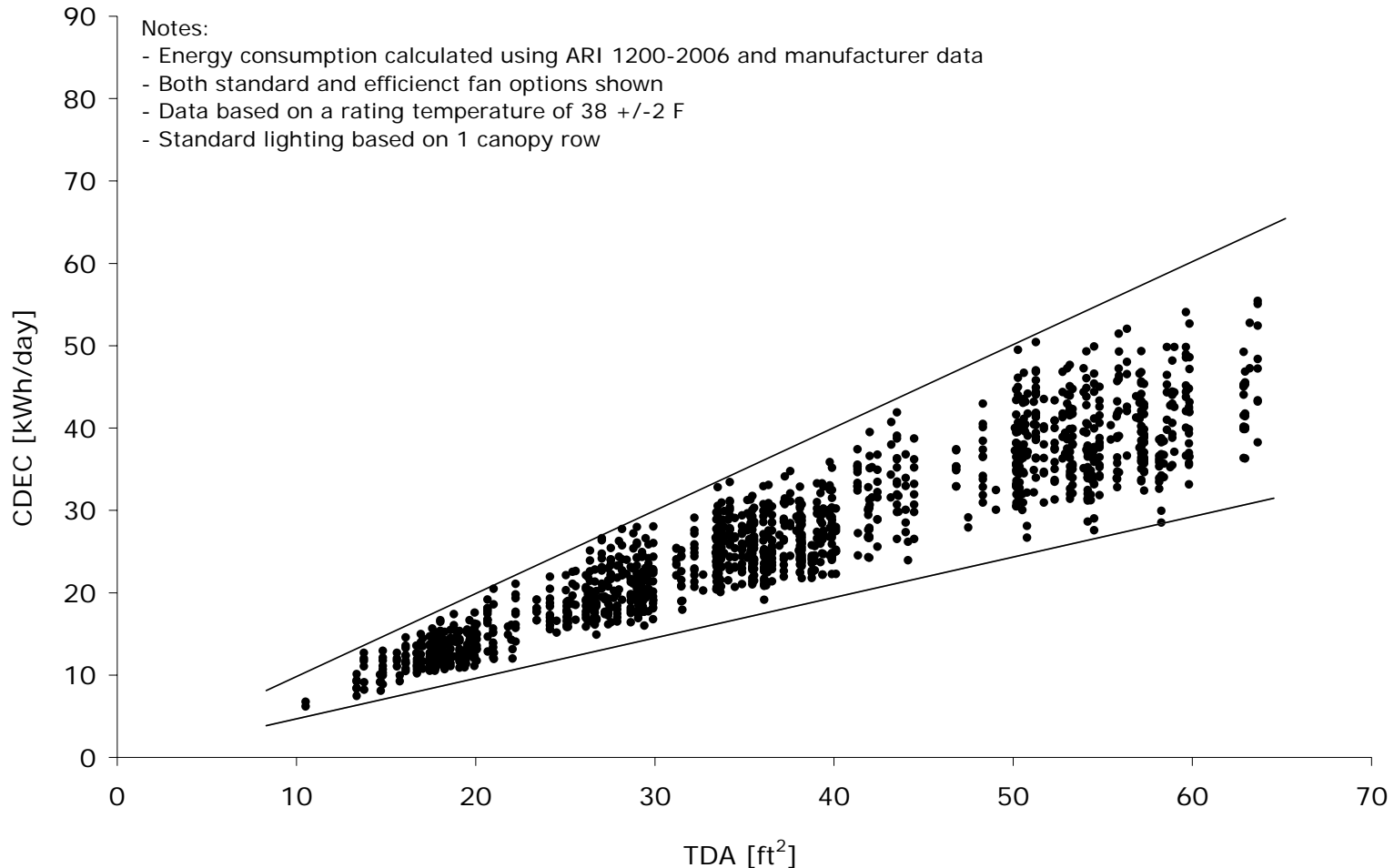



## Baseline Units

- Will be selected once product classes are established
- Are selected for each product class, against which changes resulting from energy conservation standards can be measured
- Represent typical characteristics of equipment in that class
- Are used in the engineering analysis and the life-cycle cost and payback period analysis
- Since no standards exist, the Department is surveying publicly-available product literature to establish baseline models.
- The Department also proposes to use information provided by stakeholders in selecting appropriate baseline models.

**Item 3-11** The Department seeks feedback on how to select a baseline model for each product class.

**Item 3-12** The Department seeks information on what particular components and features characterize the baseline model in each product class (e.g., materials, dimensions, insulation, refrigerant type, compressors, evaporators, condensers, expansion devices, fans, motors, air-curtains, anti-condensate devices and controls, defrost mechanisms and controls, lighting, etc.).



## Variation of Baseline Features

- Remote-condensing refrigerators without doors, vertical orientation

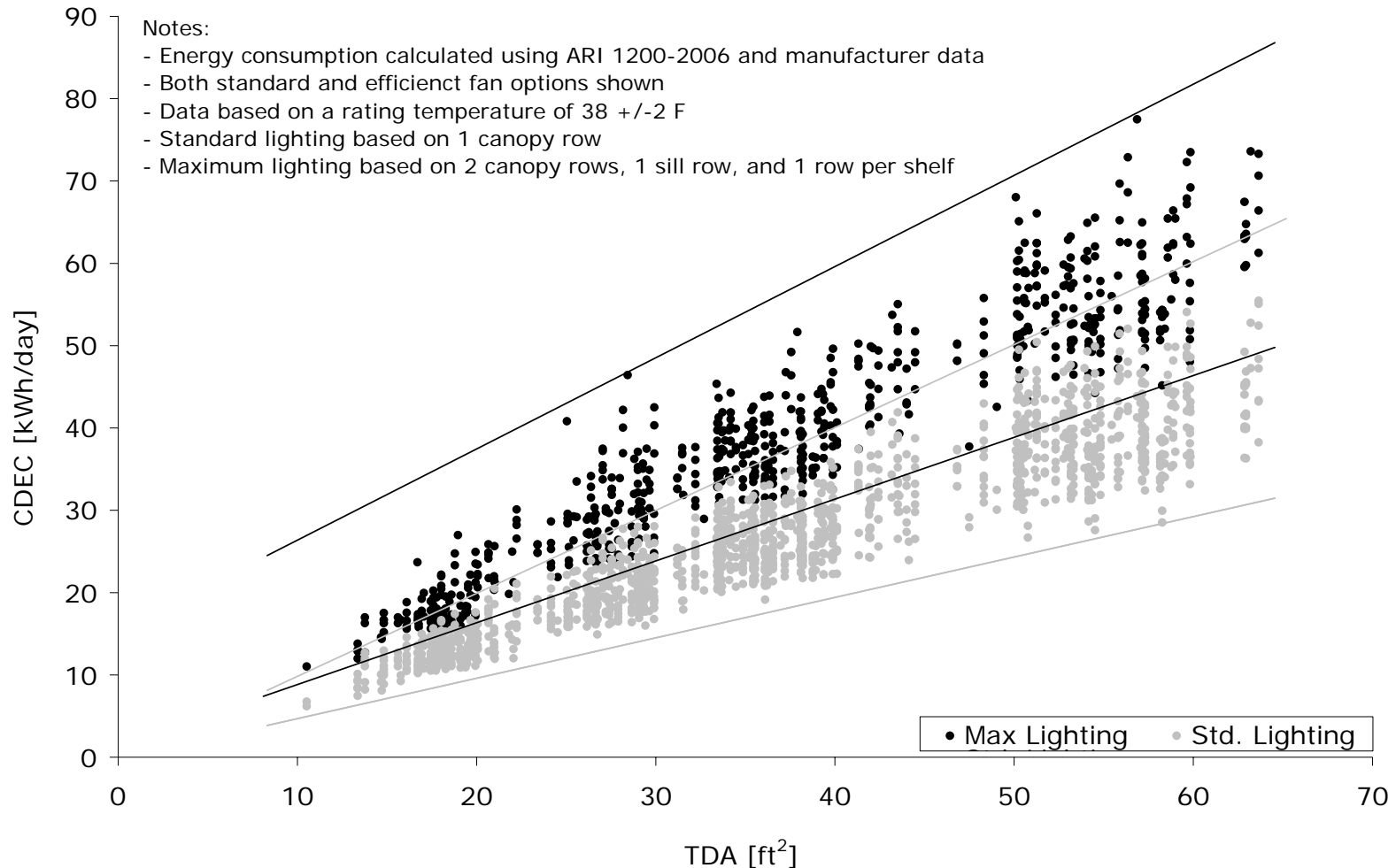



# Analyses for Advance Notice of Proposed Rulemaking

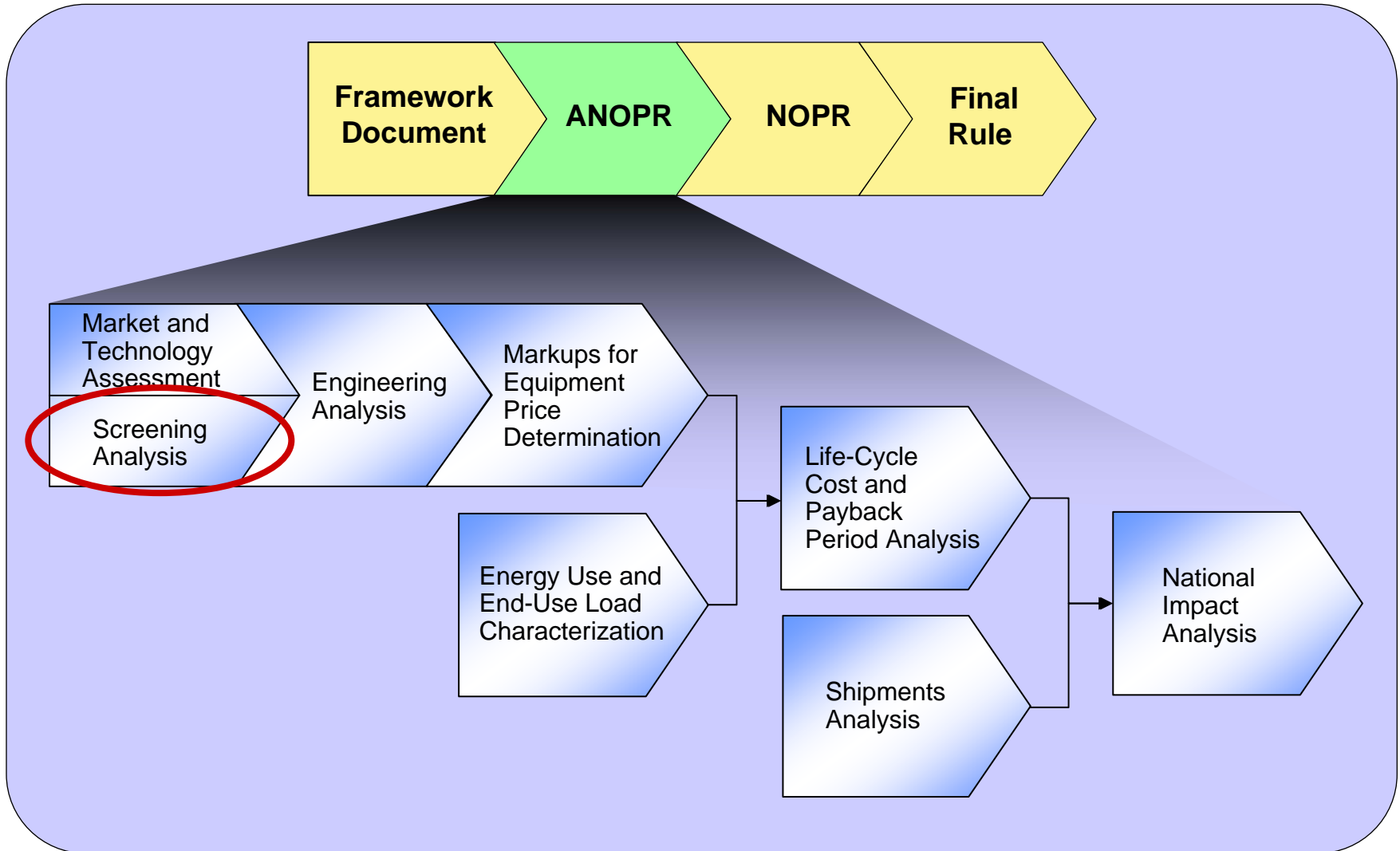



## Purpose

- Screen out technology options that will not be considered in the rulemaking for commercial refrigeration equipment

## Method

- Each technology will be screened based on the following four criteria:

**Technological feasibility**

**Practicability to manufacture,  
install and service**

**Adverse impacts on utility or  
availability to consumers**

**Adverse impacts on health or  
safety**



## Initial Technology Choices:

All Equipment Types
higher-efficiency lighting (e.g., T8 fluorescent lamps, light-emitting diodes (LEDs))
higher-efficiency lighting ballasts (e.g., electronic ballasts instead of magnetic ballasts)
remote lighting ballast location (i.e., outside the refrigerated space)
higher-efficiency expansion valves (e.g., dual-port thermostatic expansion valves (TXVs) and electronic expansion valves (EEVs))
higher-efficiency evaporator fan motors (e.g., electronically commutated motors (ECM))
increased evaporator surface area or efficiency to achieve lower case-evaporator temperature differential (with a possible increase in fan energy)
evaporator fan motor controllers
higher-efficiency evaporator fan blades
low pressure-differential evaporators
anti-sweat heater controls
case insulation increases or improvements
defrost mechanism (hot-gas defrost rather than electric defrost)
defrost cycle control (partially or fully demand-based defrost rather than partially or fully time-based defrost)



## Initial Technology Choices (con't):

### Equipment without doors only

air curtain design (i.e., optimization of the discharge air grille (DAG) configuration and velocity profile to minimize ambient air infiltration)

### Self-contained equipment only

higher-efficiency compressors (e.g., variable-speed compressors)

liquid-to-suction heat exchanger (LSHX) (i.e., subcool liquid refrigerant with suction line)

increased condenser surface area or efficiency to achieve lower ambient-condenser temperature differential (with a possible increase in fan energy)

higher-efficiency condenser fan motors (e.g., electronically commutated motors (ECM))

condenser fan motor controllers

higher-efficiency condenser fan blades

**Item 3-10** What technologies or designs, if any, should be added to or removed from the above list?



# Analyses for Advance Notice of Proposed Rulemaking

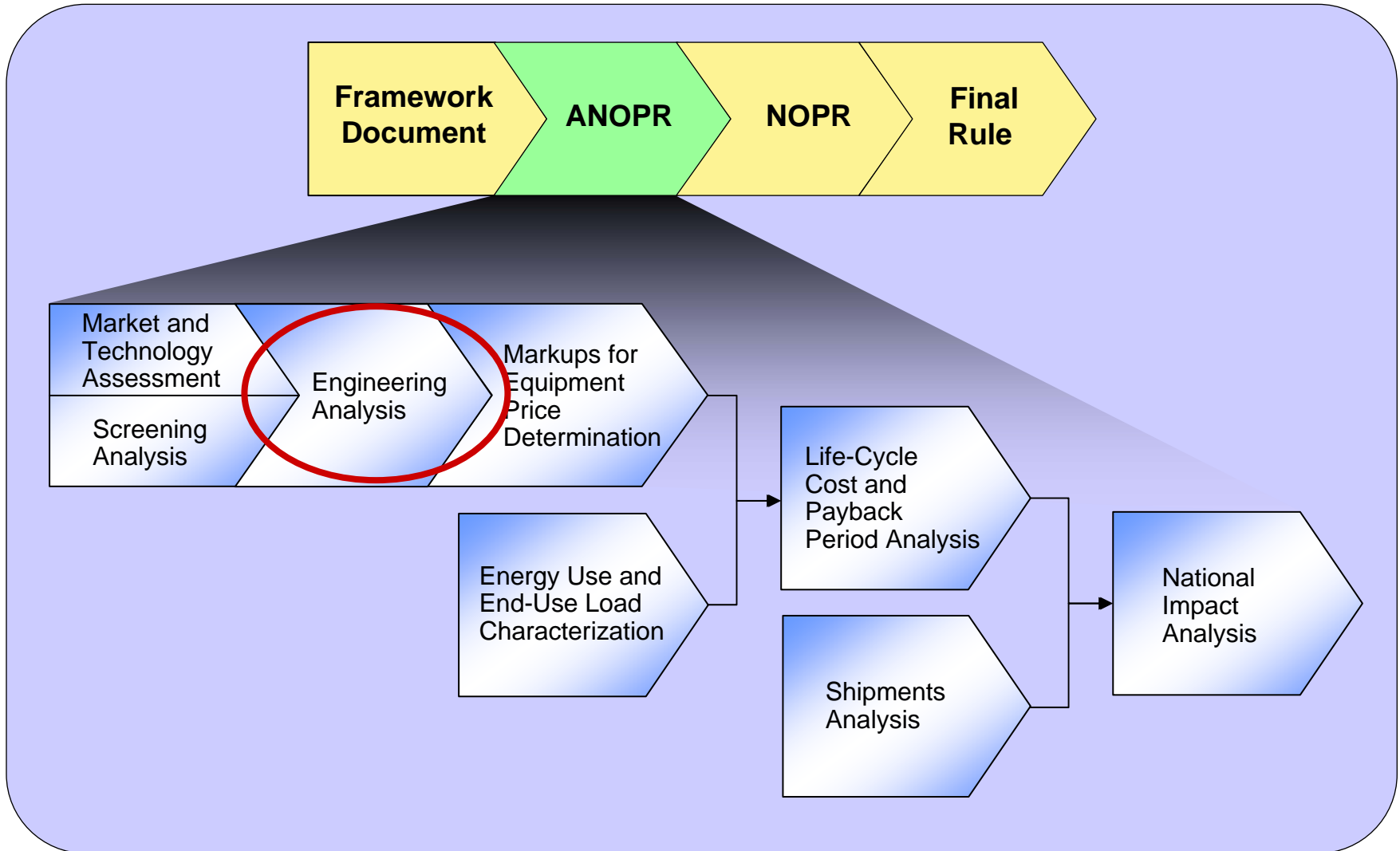



## Purpose

- Characterize the relationship between manufacturer cost and energy consumption

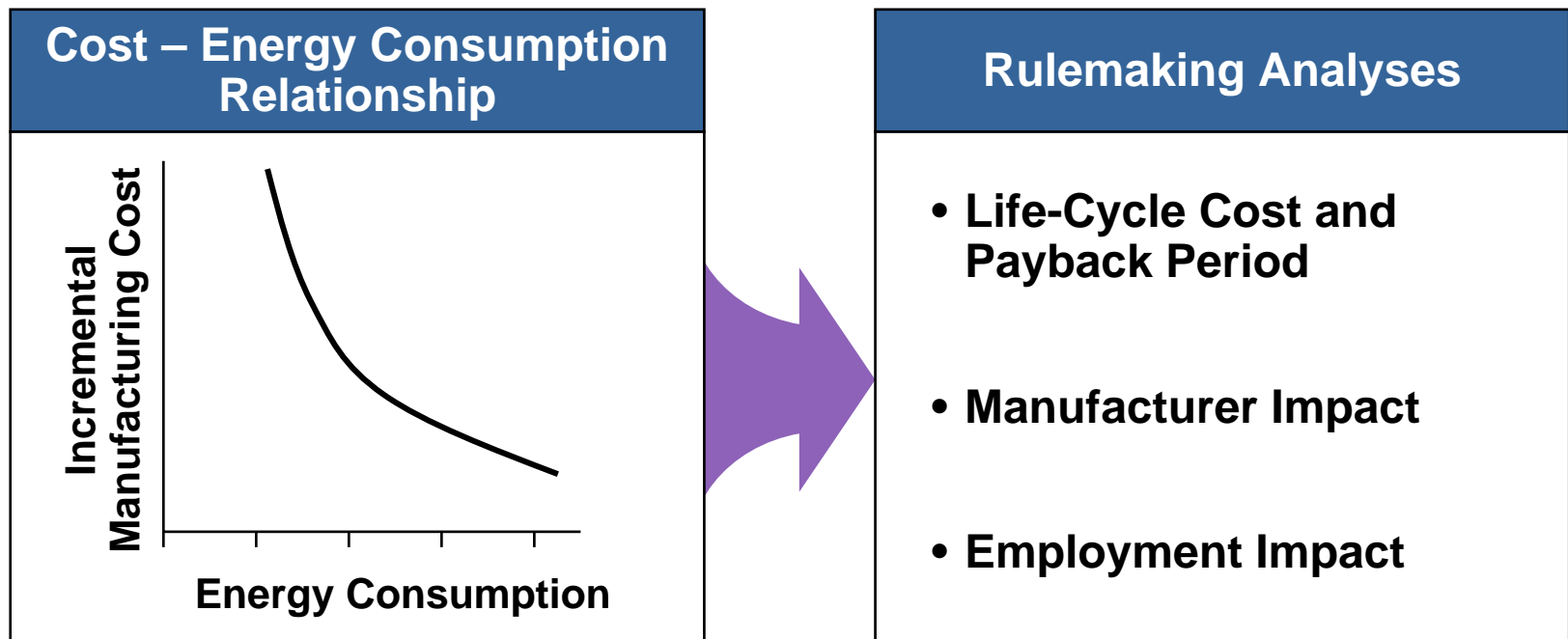



## Method

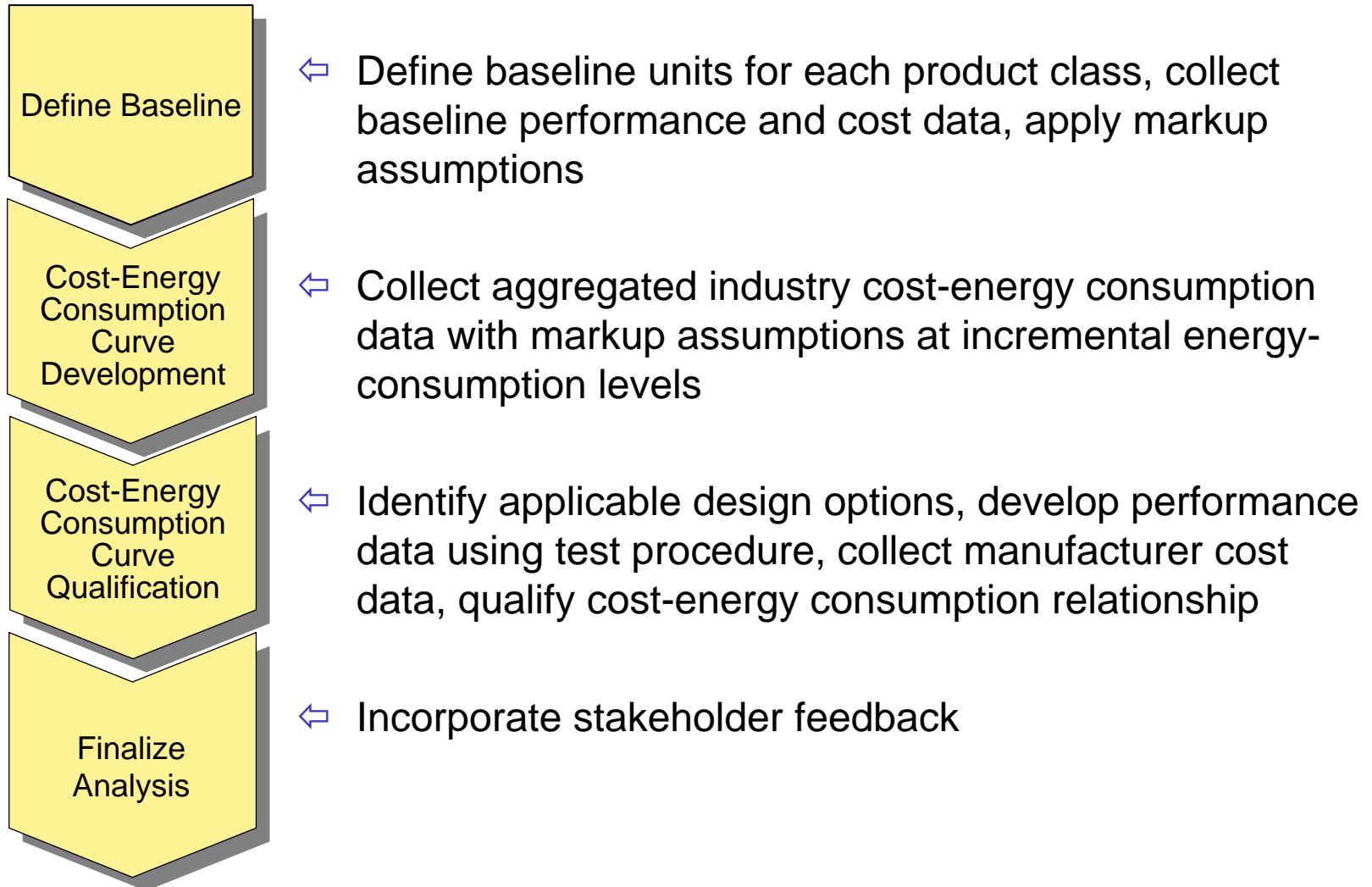



# Cost-Energy Consumption Curve Development

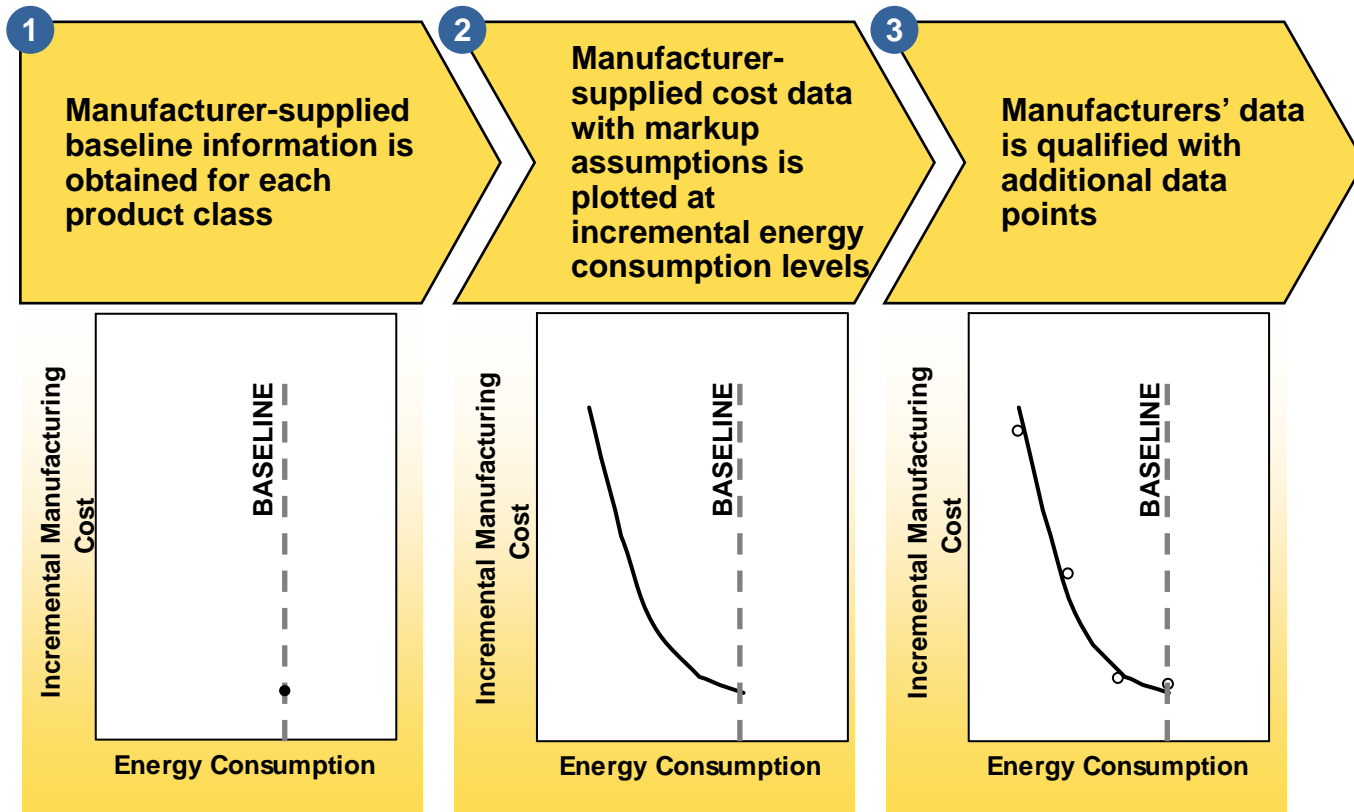



## Request for Feedback

**Item 5-1** For each product class, the Department seeks information on incremental manufacturing costs and components (see Item 3-12) for four energy-consumption levels above the baseline (e.g., daily energy consumption, what components are different from the baseline, material costs, labor costs, overhead costs (excluding depreciation), building conversion capital expenditures, tooling/equipment conversion capital expenditures, R&D expenses, marketing expenses, etc.).

**Item 5-2** The Department is also interested in any equipment test data that stakeholders can provide (e.g., test procedure used, rating conditions, refrigerated volume, total display area, case length, voltage, integrated average product temperature, daily energy consumption, etc.). Test data for the baseline model in each product class is particularly important.



## Cost-Energy Consumption Curve Qualification

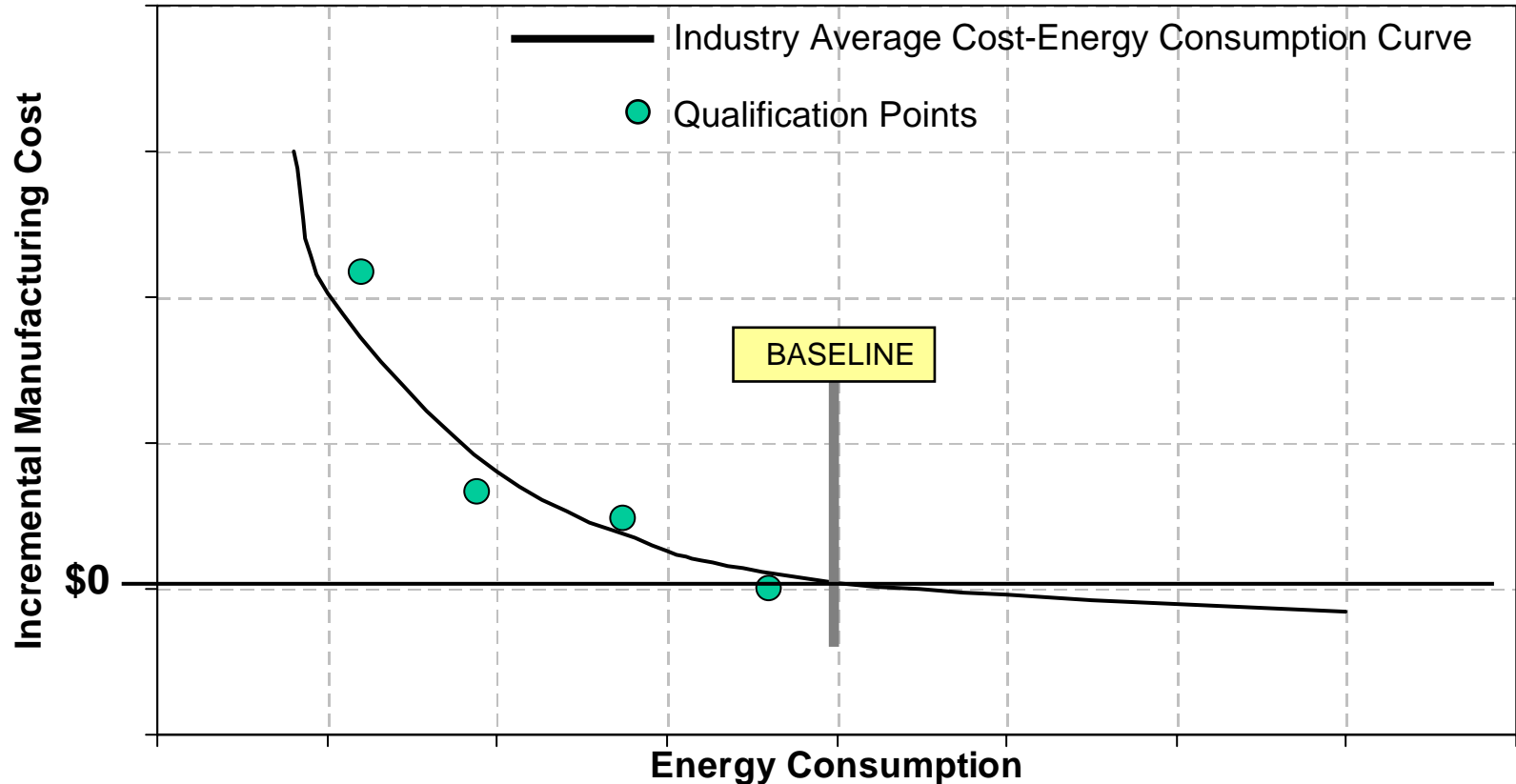

**Item 5-3** The Department requests feedback on the use of an efficiency-level approach to determining the relationship between manufacturer selling price and energy consumption for commercial refrigeration equipment, supported, as needed, by a design-options approach.



## Manufacturing Cost Components



- Direct material
- Direct labor
- Factory overhead
- Depreciation

- Sales & marketing
- Research & development
- Interest
- Profit

- Examples of publicly available information:
  - SEC 10-K reports
  - Company annual reports
  - Dun and Bradstreet reports
  - Value Line industry statistics
  - Standard and Poor's composite industry statistics
  - Ibbotson Associates reports

**Item 5-4** The Department seeks comment on the markup approach proposed for developing estimates of manufacturer selling prices.



## Proprietary Designs

- The Department will evaluate all design options that are commercially available or present in a working prototype, including proprietary designs.
- Proprietary designs will only be considered if they do not present a unique path to a given energy consumption level.
- The confidentiality of manufacturers will be maintained.

## Outside Regulatory Changes

- Consider the effects to manufacturers of other regulatory changes outside of the standards rulemaking process.

**Item 5-5** Are there proprietary designs that the Department should consider for any of the products under consideration by this rulemaking? If so, how should the Department acquire the cost data necessary for evaluating these designs?

**Item 5-6** Are there additional outside issues that the Department should consider in its analysis of commercial refrigeration equipment?



## Analyses for Advance Notice of Proposed Rulemaking

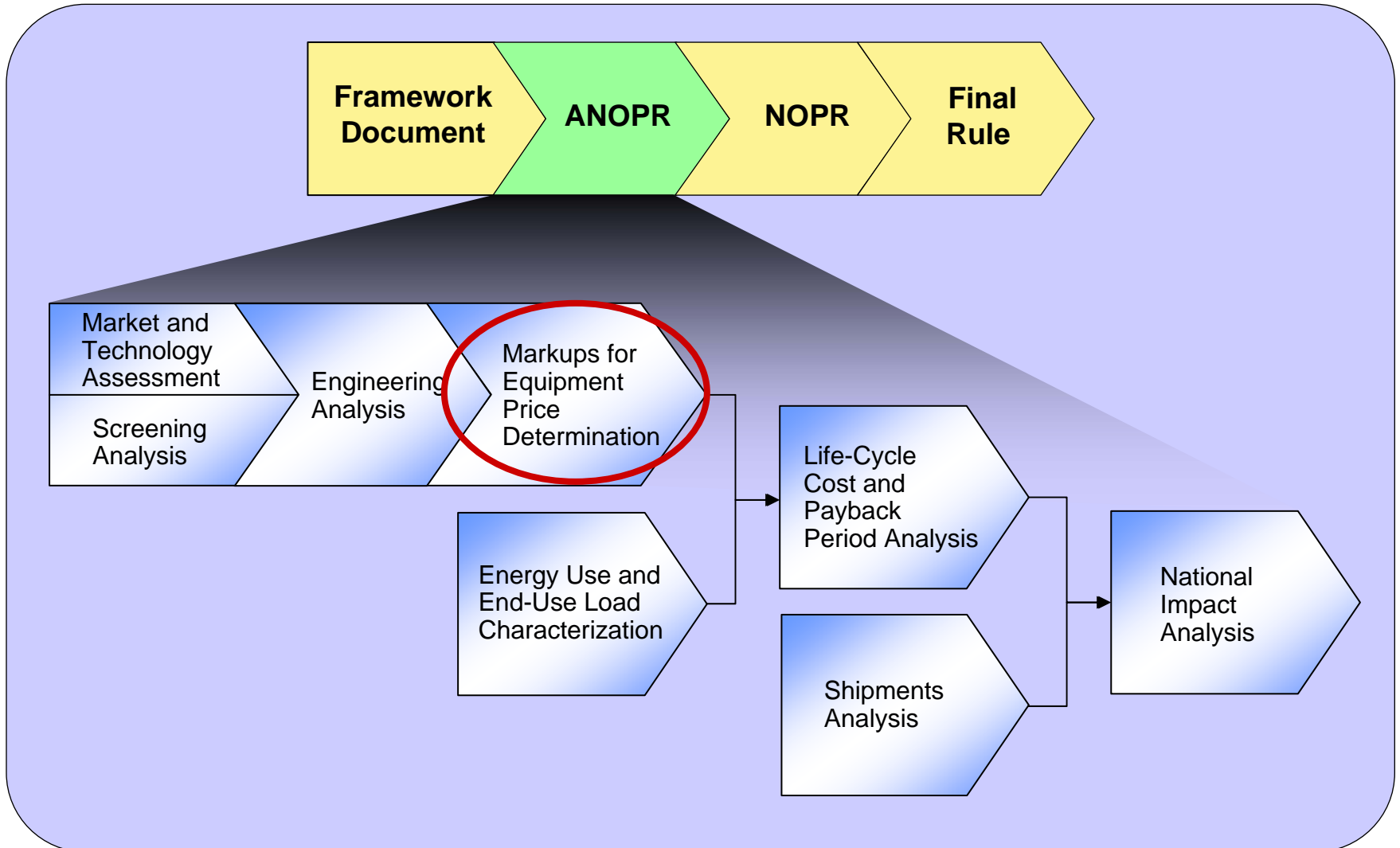



## Purpose

- Develop overall distribution chain price markups from the manufacturer to the consumer
- Establish the consumer prices for both baseline equipment and equipment at higher standard levels

## Distribution Channels

### Distribution Channel 1

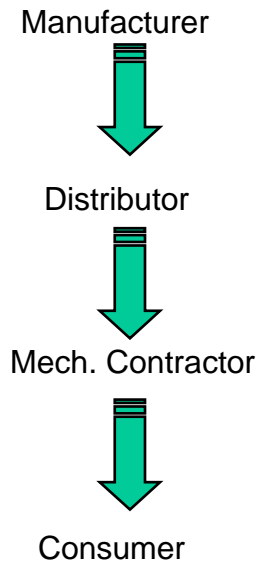

### Distribution Channel 2

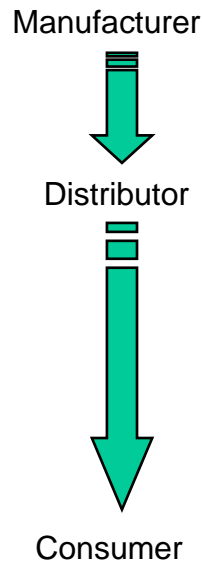

### Distribution Channel 3 (Nat'l Acct)

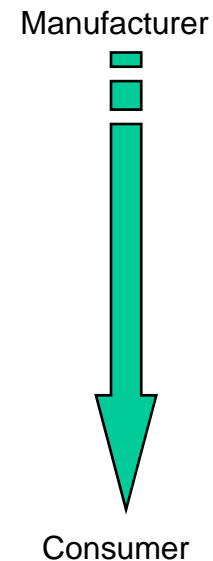



# Two Types of Markups in Distribution Chain: Baseline and Incremental

- Markups relate consumer price to cost of goods sold (CGS).
  - Baseline markups relate price to cost prior to a change in efficiency.
  - Baseline markups indicate a consumer price that covers all of a Distributor's or Contractor's expenses plus profit.

### **Some costs may remain constant when CGS increases**

- Incremental markups relate the incremental change in consumer price to the incremental change in CGS.
  - Incremental markups cover only expenses that vary with CGS – in this case, expenses that increase due to an increase in equipment efficiency.
  - Certain costs, such as direct labor costs (salaries, payroll, rental and occupancy) do not vary with efficiency induced changes in CGS and remain constant in the calculation of incremental markups.



# Request for Feedback

**Item 7-1** The Department requests information from stakeholders on whether the distribution paths for the commercial refrigeration equipment covered under this rulemaking would be similar to those for CUAC, and, if not, how the two might differ. The Department also requests information on the relative fractions of shipments expected for each path in an appropriate distribution chain for the commercial refrigeration equipment covered under this rulemaking.

**Item 7-2** The Department requests feedback on if the overall markups for the commercial refrigeration equipment covered under this rulemaking for each path in the distribution chain are likely to be similar to those developed for commercial unitary air conditioners for the same distribution paths.

**Item 7-3** The Department requests feedback on its proposal to use incremental distribution chain markups for the LCC analysis.

**Item 7-4** The Department seeks comment on other sources of relevant data that could be used to characterize markups for the commercial refrigeration industry.



## Analyses for Advance Notice of Proposed Rulemaking

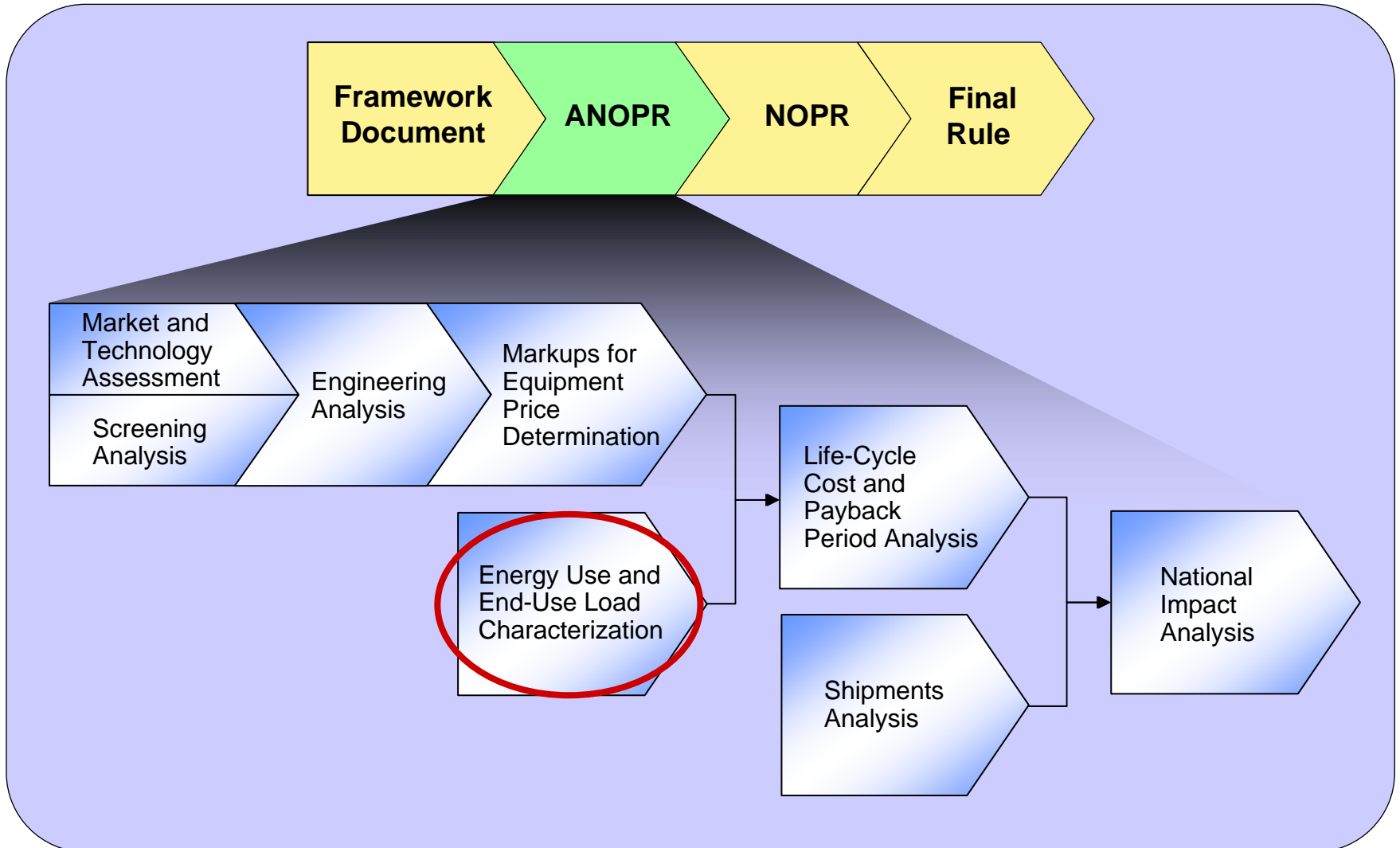



## Purpose

- Develop energy use and peak electricity demand characteristics for buildings that use commercial refrigeration equipment
- Provide the basis for the unit energy costs used in the Life-Cycle Cost Analysis.

- Why building-level analysis?

Energy use from commercial refrigeration equipment has both a direct refrigeration electrical use impact in these buildings as well as significant space heating and cooling impacts.



**For Remote Cabinets:  
Refrigeration load drawn from space  
and exits building as condenser heat**



### Method

- The Department proposes to use whole building simulation tools incorporating commercial refrigeration equipment models to assess the net energy impact of efficiency standard levels for CRE in typical building types using the equipment.
- The Department proposes to examine two prototypical buildings, a full size supermarket and a convenience store, both of which it will simulate in a variety of locations around the U.S.
- Statistical data will be used to develop appropriate weights for the resulting energy use data. These weights will be used to develop regional and national average net energy use figures as well as energy use distributions for specific equipment classes and efficiency levels.



### Request for Feedback

**Item 6-1** The Department seeks stakeholder input on whether the impact of higher efficiency refrigeration equipment on the building space conditioning loads is significant enough to warrant taking them into account in the energy analysis, and if so, what methods could be used to estimate the net energy consumption and load impacts of higher efficiency commercial refrigeration equipment in buildings using this equipment.

**Item 6-2** The Department specifically requests input on the viability of defining a limited set of building prototypes for all equipment classes in order to characterize energy use. If a limited set of building prototypes is acceptable, the Department seeks stakeholder input on how to properly characterize the building prototypes.

**Item 6-3** The Department seeks data or data sources that could be used to characterize the energy use and loading of commercial refrigeration equipment.

**Item 6-4** The Department seeks feedback on this approach to the energy use and end-use load characterization.



## Analyses for Advance Notice of Proposed Rulemaking

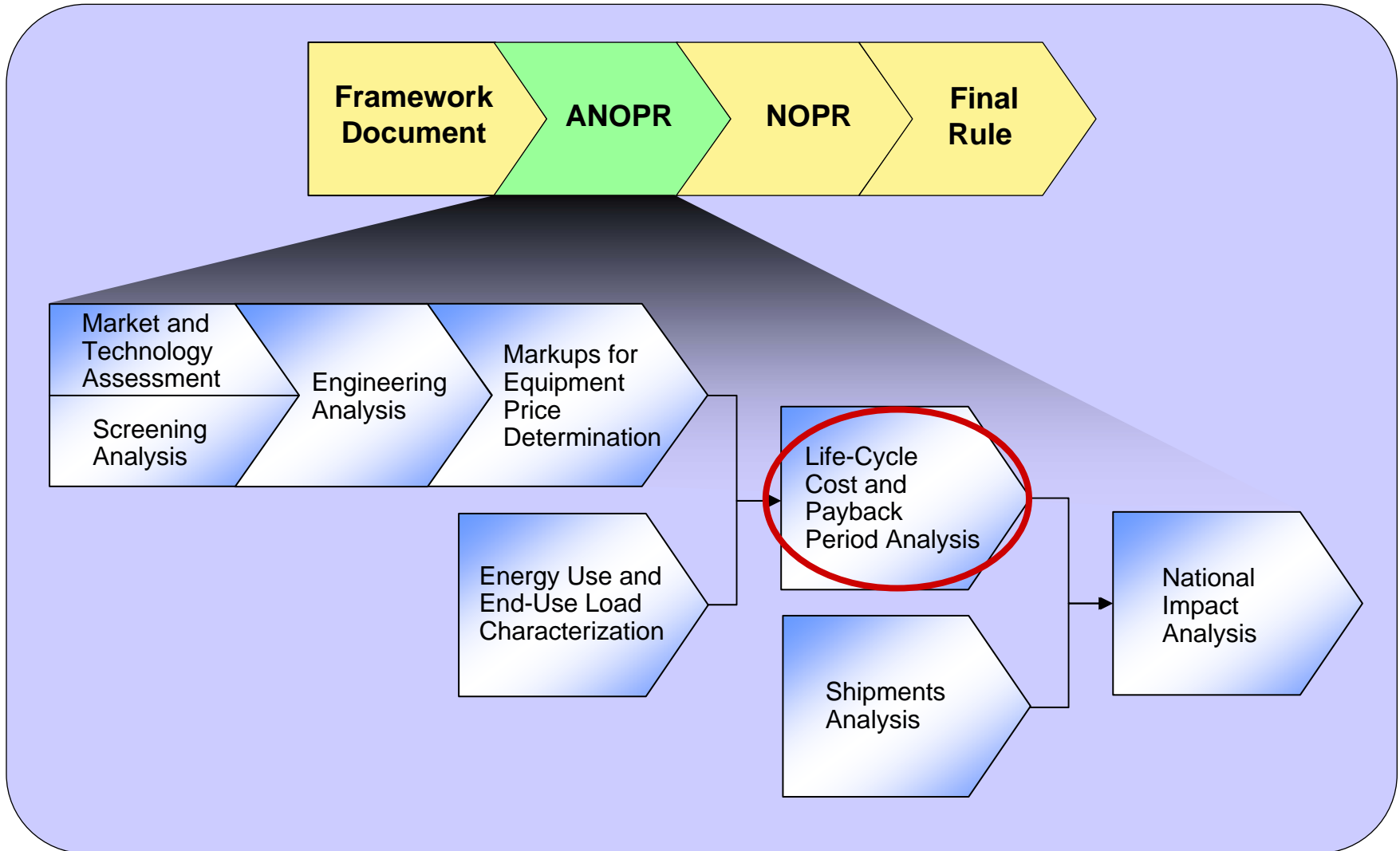



## Purpose

- Assess the net life cycle cost (LCC) impacts of differing efficiency standards for commercial refrigeration equipment on the consumer

## Method

- LCC equals consumer price plus the sum of annual operating costs discounted to a particular base year
- Economic evaluation from the consumer perspective
- Analysis Implemented in an Excel<sup>®</sup> spreadsheet
- Results are expressed as LCC difference (baseline minus standard level)
- Simple Payback (years) is also calculated and reported in this analysis

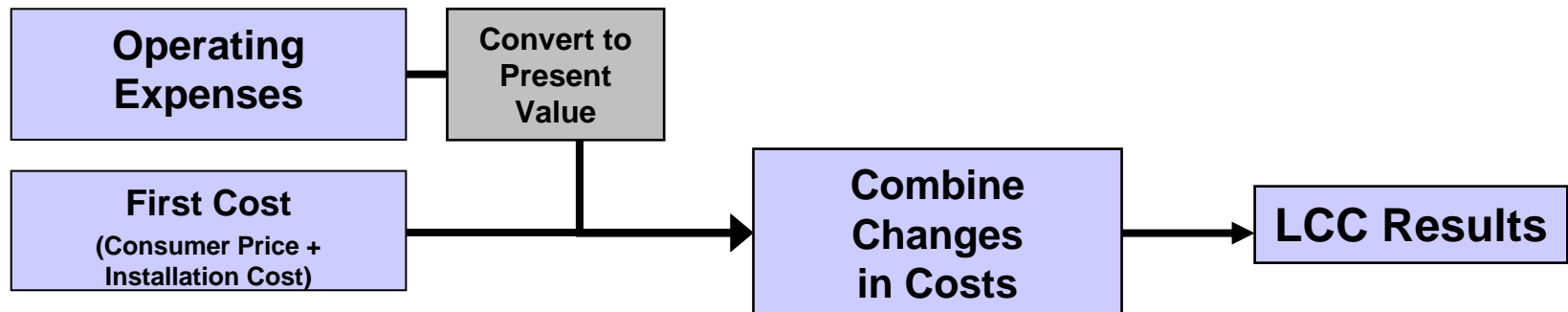



# Life-Cycle Cost and Payback Period Analysis

## LCC Flowchart

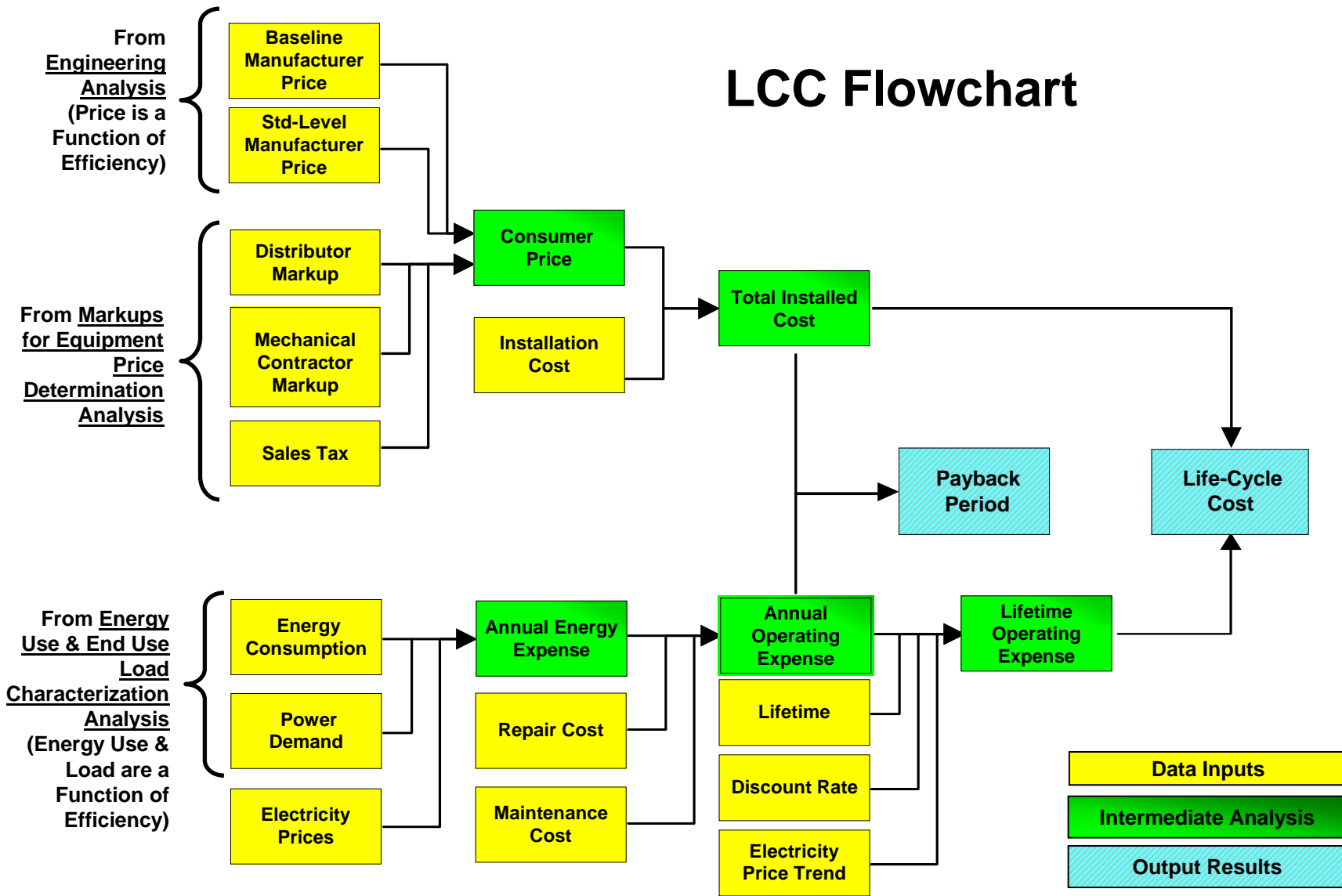



### Energy Prices

- Energy prices are necessary to convert the energy use statistics for the buildings analyzed to energy costs.
- The Department proposes to use regional average electricity and natural gas fuel prices for the commercial building sector for its analysis of commercial refrigeration equipment.
- The Department will use the Energy Information Administration (EIA) *Annual Energy Outlook (AEO)* as the default source of projections for future energy prices.

**Item 8-1** The Department seeks comment on the proposed approaches for estimating current and forecasted energy prices.



### Discount Rates

- Discount rates are used to convert streams of annual operating expenses to present value in the LCC analysis.
- The Department will derive the LCC discount rates by estimating the weighted average cost of capital (WACC) for companies that purchase commercial refrigeration equipment.
- The Department proposes that the WACC be derived from estimates of the cost of capital of companies and store chains primarily in the food sales business (e.g. grocery and convenience stores).

**Item 8-2** The Department seeks comment on the proposed approaches for estimating discount rates for consumers using the equipment covered under this rulemaking.

**Item 8-3** Given the relatively narrow commercial application of most of the equipment covered under this rulemaking, which, if any, commercial sectors beyond grocery stores should be considered in the evaluation of discount rates? In addition, do stakeholders feel government purchases of this equipment are large enough to require that they be included in the evaluation of discount rates?



### Other LCC and PBP Analysis Inputs

- Installation Cost
- Equipment Lifetime
- Repair Costs
- Maintenance Costs

**Item 8-4** The Department seeks feedback on whether it is correct to assume that changes in maintenance, repair, and installation costs will be negligible for equipment with lower energy consumption.

**Item 8-5** If it is not appropriate to assume that changes in maintenance, repair, or installation costs would be negligible for equipment with lower energy consumption, the Department seeks comment on appropriate methodologies for assessing changes to each of these costs.

**Item 8-6** The Department seeks comment on appropriate equipment lifetimes for the equipment covered in this rulemaking.



# Analyses for Advance Notice of Proposed Rulemaking

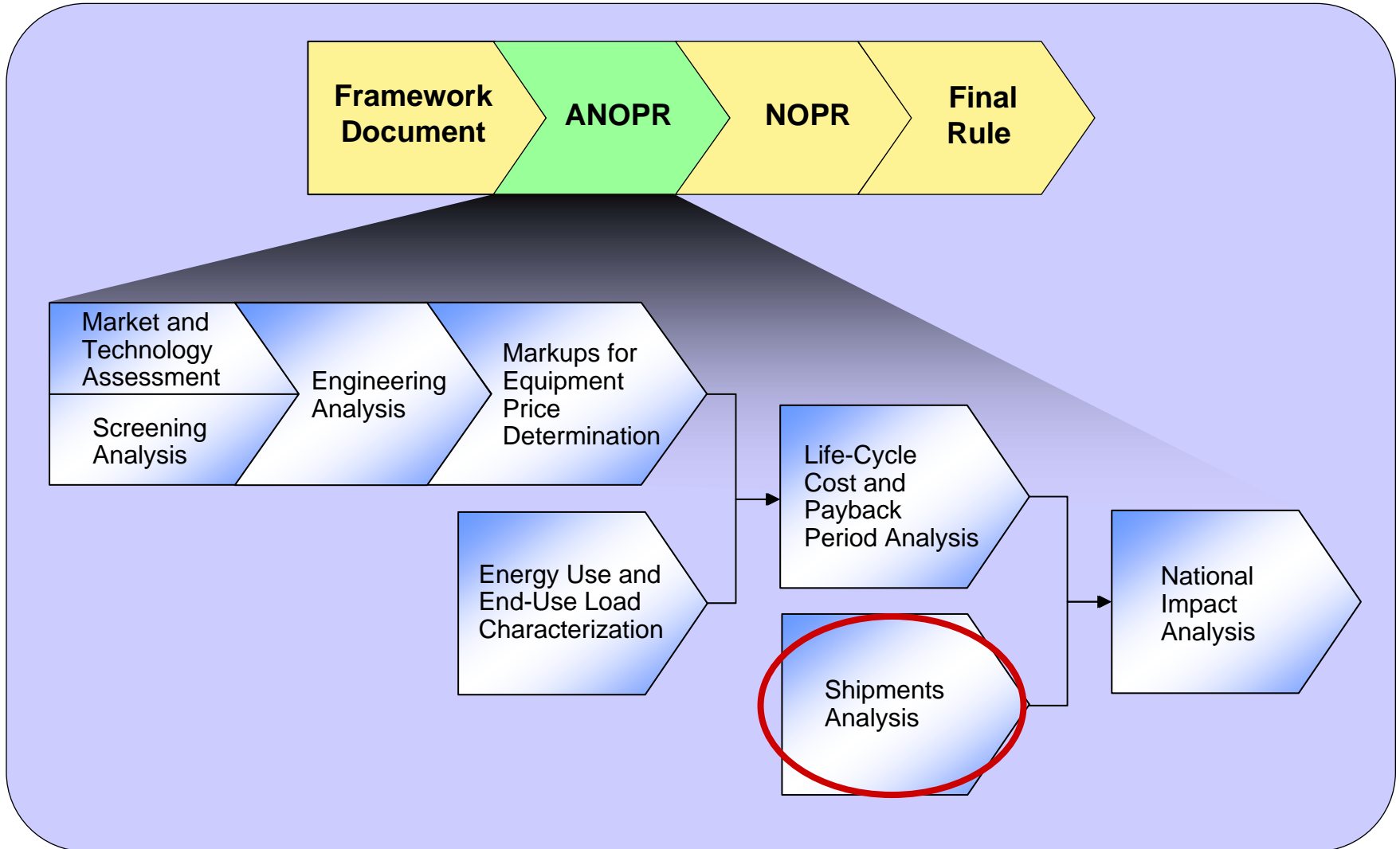



### Purpose

- Project the rate of new equipment shipments under a proposed standard
- Track the CRE stock of equipment, by vintage, over the time frame of the standard

### Method

- The life cycle of equipment is modeled as a “birth–death” process in which equipment moves from one state to another
  - New equipment is purchased and shipped to a building
  - Equipment operates for some number of years in a building
  - The equipment is retired
- Data sources used include: product lifetimes, estimates of commercial floor space, current product saturation rates by building type
- The shipments model is calibrated to historical shipments and market saturation data



## Request for Feedback

**Item 9-1** The Department seeks information on representative saturation rates for each product class covered under this rulemaking, as well as industry-trend data regarding relative growth in each product class.

**Item 9-2** As part of its preliminary manufacturer impact analysis, the Department will seek input from manufacturers on the potential impact of new energy conservation standards on product shipments. Other stakeholders are also welcome to provide input. The Department also requests input on any market-pull programs that currently exist to promote the adoption of more-efficient products.



# Analyses for Advance Notice of Proposed Rulemaking

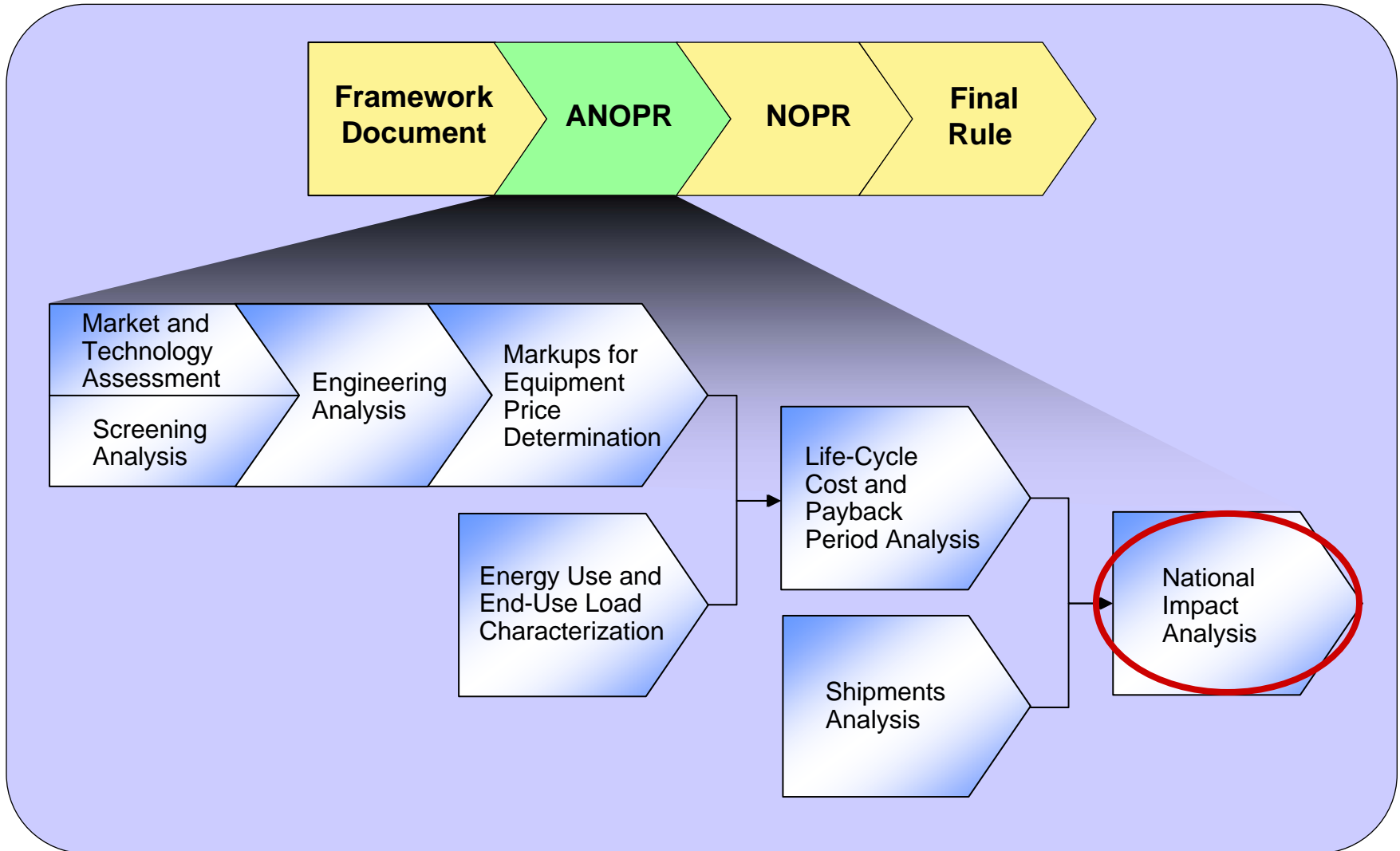



## Purpose

- Develop National Energy Savings (NES) and National Net Present Value (NPV) impact estimates for higher-efficiency standard levels.

## Method

- Uses a spreadsheet-based analysis tool
- Develops annual time series of energy and economic impacts
- Provides national summations of impacts for defined analysis periods
- Utilizes the shipments model to estimate the total stock of commercial refrigeration equipment in service in any year
- Utilizes the LCC to estimate cost and energy use per unit in any given year
- Aggregates the costs and energy use, by vintage, for all years in the analysis period
- Reports estimates for energy use at the source of production (Quads Source Energy)
- Reports estimates for economic impact as change in National Net Present Value (in constant year dollars)
- Accounts for the time-value of money through use of defined discount rates



## Request for Feedback

**Item 10-1** The Department seeks comment on its plan to develop NES spreadsheet models for estimating national impacts of amended energy conservation standards.



## Public Meeting Agenda

- 1 Introduction
- 2 Rulemaking Overview
- 3 ANOPR Analyses
- 4 NOPR Analyses**
- 5 Final Rule Analyses
- 6 Closing Remarks



# Analyses for Notice of Proposed Rulemaking

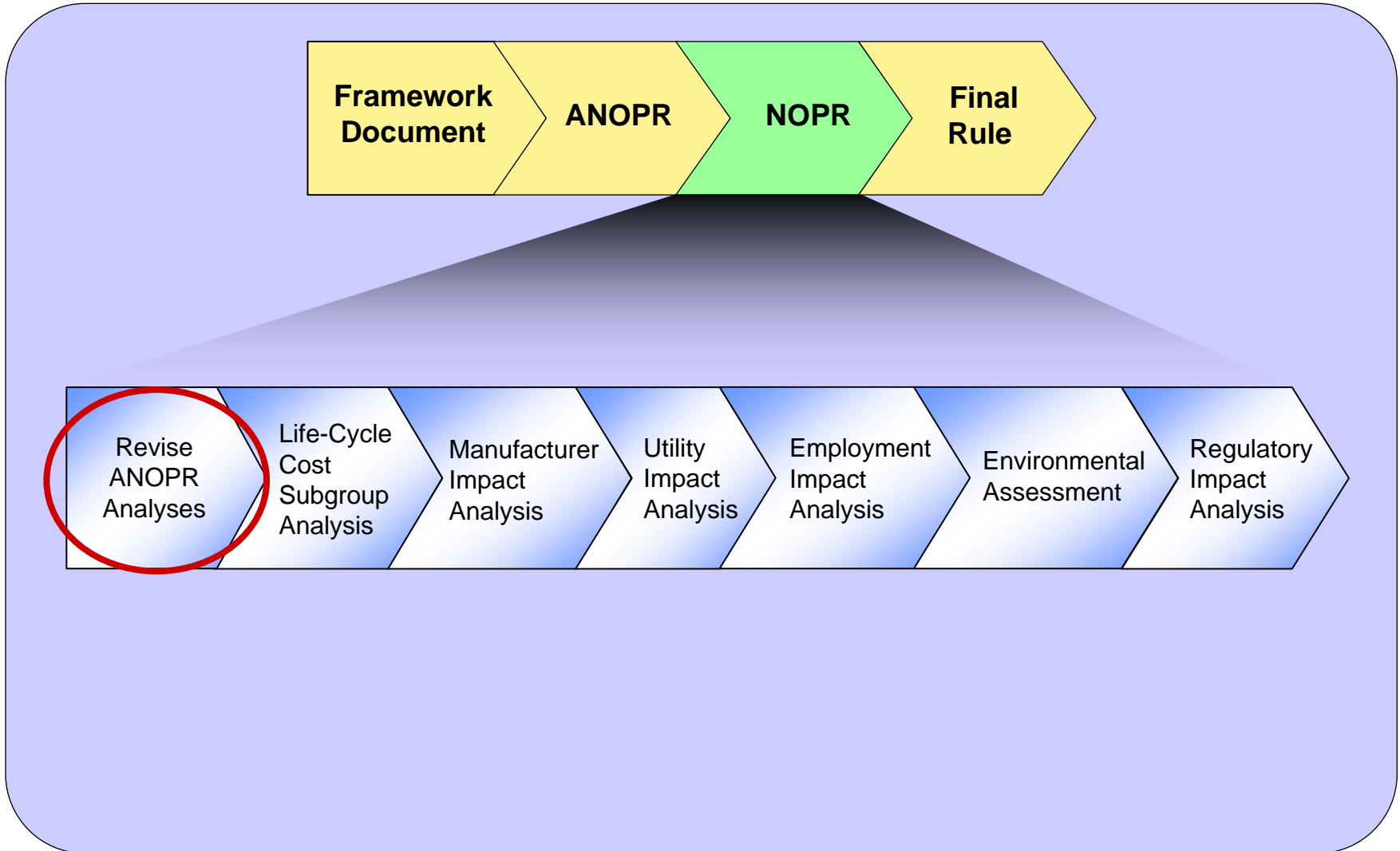



# Analyses for Notice of Proposed Rulemaking

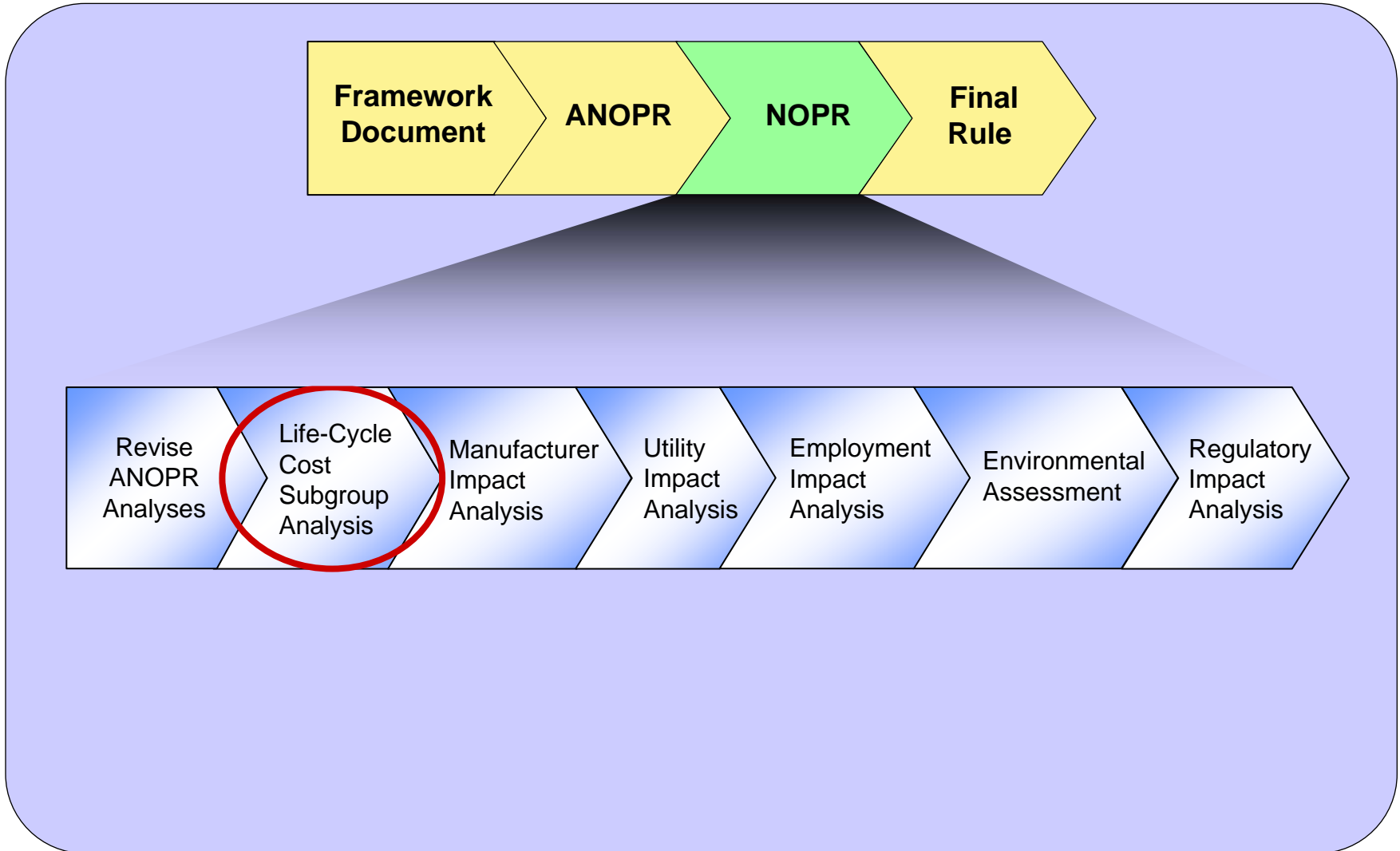



### Purpose

- Analyze the economic impacts of standards on consumer subgroups who may be disproportionately impacted compared with the general user population

### Method

- Extend the LCC analysis to examine the impacts for defined subgroups

**Item 11-1** The Department seeks input as to what consumer subgroups the Department should consider in the present rulemaking. Examples of possible subgroups the Department could consider appropriate for commercial refrigeration equipment include independent grocery stores and small convenience stores.



# Analyses for Notice of Proposed Rulemaking

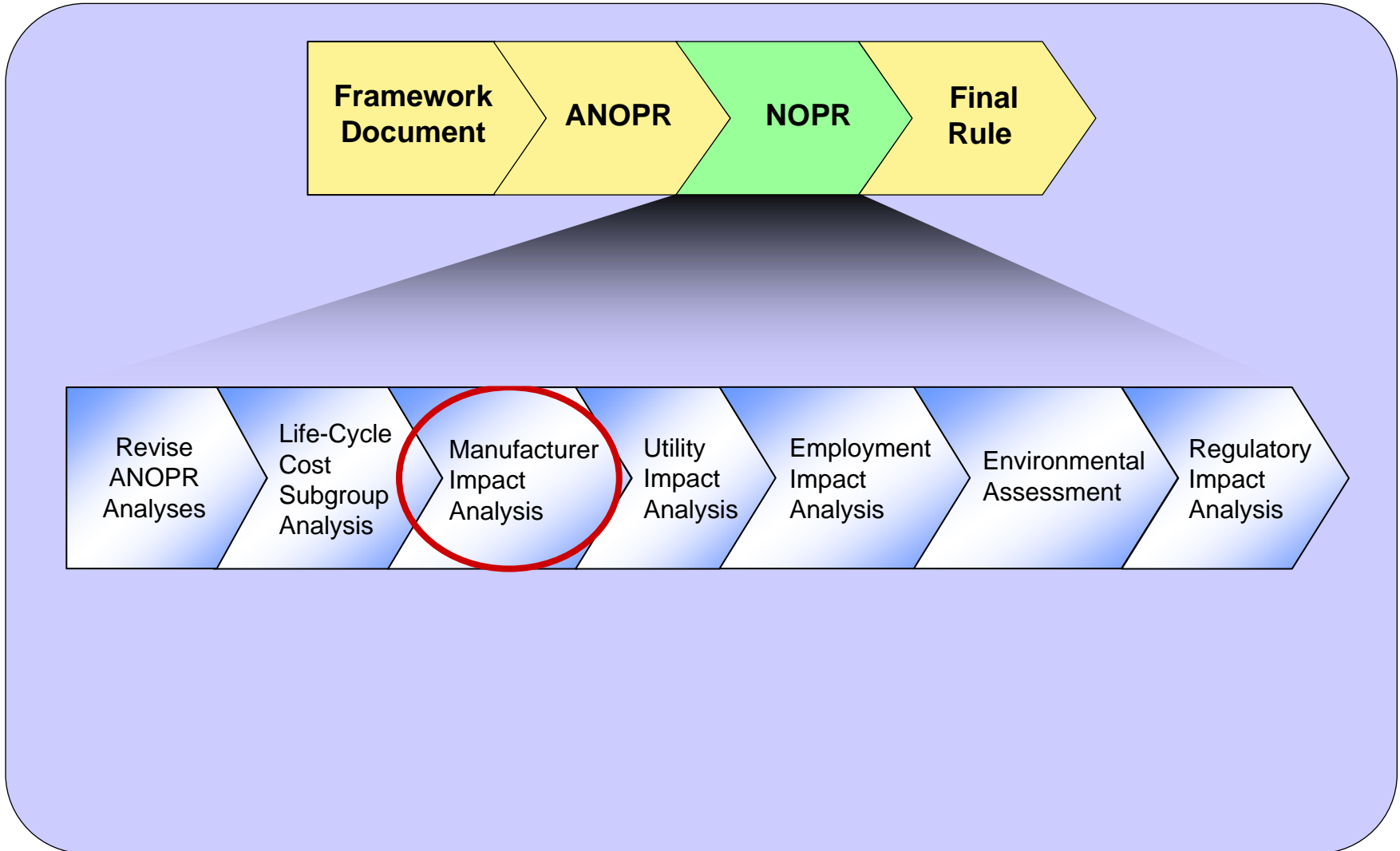



### Purpose

- Assess the impacts of standards on manufacturers
- Identify and estimate impacts on manufacturer subgroups that may be more severely impacted than the industry as a whole
- Examine the impact of cumulative regulatory burden on the industry

### Method

- Analyze industry cash flow and net present value through use of the Government Regulatory Impact Model (GRIM)
- Interview manufacturers to refine inputs to the GRIM, develop subgroup analyses, and address qualitative issues

### Output

- Industry Net Present Value impacts
- Subgroup Net Present Value impacts
- Other impacts



# Legislative Requirements

- The Manufacturers Impact Analysis (MIA) fulfills a legislative requirement to determine if a proposed standard is economically justified.
  - The Energy Policy and Conservation Act (EPCA) provides seven factors to be evaluated in determining whether an appliance efficiency standard [energy conservation standard] is justified. (42 U.S.C. 6313(a)(6)(B)(i)) Two of these factors require DOE to consider the **economic impact of standards on manufacturers** and the impacts of any lessening of competition in the industry. Both of these factors are assessed through the manufacturer impact analysis.
  - In September, 1995, the Department announced a formal effort to consider further improvements to the process used to develop appliance efficiency standards. As a result of this combined effort, the Department published Procedures, Interpretations and Policies for Consideration of New or Revised Energy Conservation Standards for Consumer Products (the “process rule”), 10 CFR 430, Subpart C, Appendix A. The process rule contains **principles for the analysis** of regulatory impacts on manufacturers
  - Recently, the Department announced changes to the manufacturer impact analysis format through a report issued to Congress on January 31, 2006 (as required by section 141 of EPCA 2005). Under this new format, DOE will collect, evaluate, and report **preliminary manufacturer impact analysis** information in the ANOPR. Such preliminary information includes the anticipated conversion capital expenditures by efficiency level and the corresponding, anticipated impacts on jobs.



## Methodology

- The MIA consists of three main phases

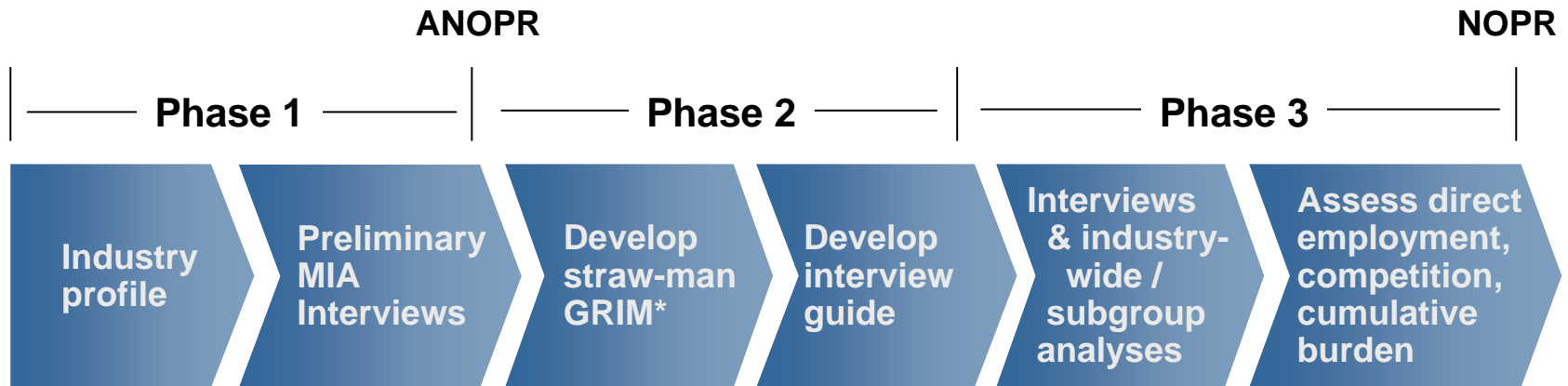

\* Government Regulatory Impact Model (GRIM)



### Methodology: Phase 1

- Consists of the industry profile and preliminary manufacturer impact analysis interviews

#### Industry Profile

- » Evaluate current and past industry structure and market characteristics
- » Produce an industry profile report with aggregated findings and characteristics
- » Identify critical issues that require special consideration in the MIA, for example:
  - » Types or groups of manufacturers
  - » Access to technology
  - » Potential regulatory scenarios

#### Preliminary MIA Interviews

- » Occurs during the engineering analysis
- » Topics include:
  - » Shipment projections
  - » Conversion costs
  - » Product mix and profitability
  - » Market shares and industry consolidation
  - » Cumulative regulatory burden



## Methodology: Phase 2

- Consists of the straw-man GRIM and interview guide preparation

### Straw-man GRIM

- » Starting point for discussion of impacts
- » Inputs include:
  - » Manufacturer prices
  - » Shipment forecasts
  - » Manufacturing cost estimates
  - » Financial information

### Interview Guide Preparation

- » Interview topics include:
  - » Engineering analysis
  - » Shipments model
  - » Cost structure and financial parameters
  - » Conversion costs
  - » Cumulative burden
  - » Direct employment impacts
  - » Import / Export issues
  - » Consolidation / competitive impacts
  - » Replacement parts or refurbishments
  - » Impact of the standard's effective date



## Methodology: Phase 3

- Consists of the manufacturer interviews, subgroup analyses, and assessment of industry impacts

### Manufacturer Interviews

- » Confidential discussion of potential impacts resulting from standards, including:
  - » Obsolescence of existing manufacturing assets
  - » Tooling
  - » Investment

### Assessment of Impacts

- » Assess competitive impacts on smaller, significant manufacturers
- » Assess cumulative regulatory burden on manufacturers from amended DOE standards and other regulatory actions
- » Assess impacts on industry employment levels
- » Assess impacts on manufacturer subgroups



## Request for Feedback

**Item 12-1** What procedures should the Department follow when scheduling interviews and requesting information?

**Item 12-2** The Department seeks comment on the establishment of manufacturer subgroups for commercial refrigeration equipment.

**Item 12-3** What regulations or pending regulations should the Department consider in the analysis of cumulative regulatory burden?



# Analyses for Notice of Proposed Rulemaking

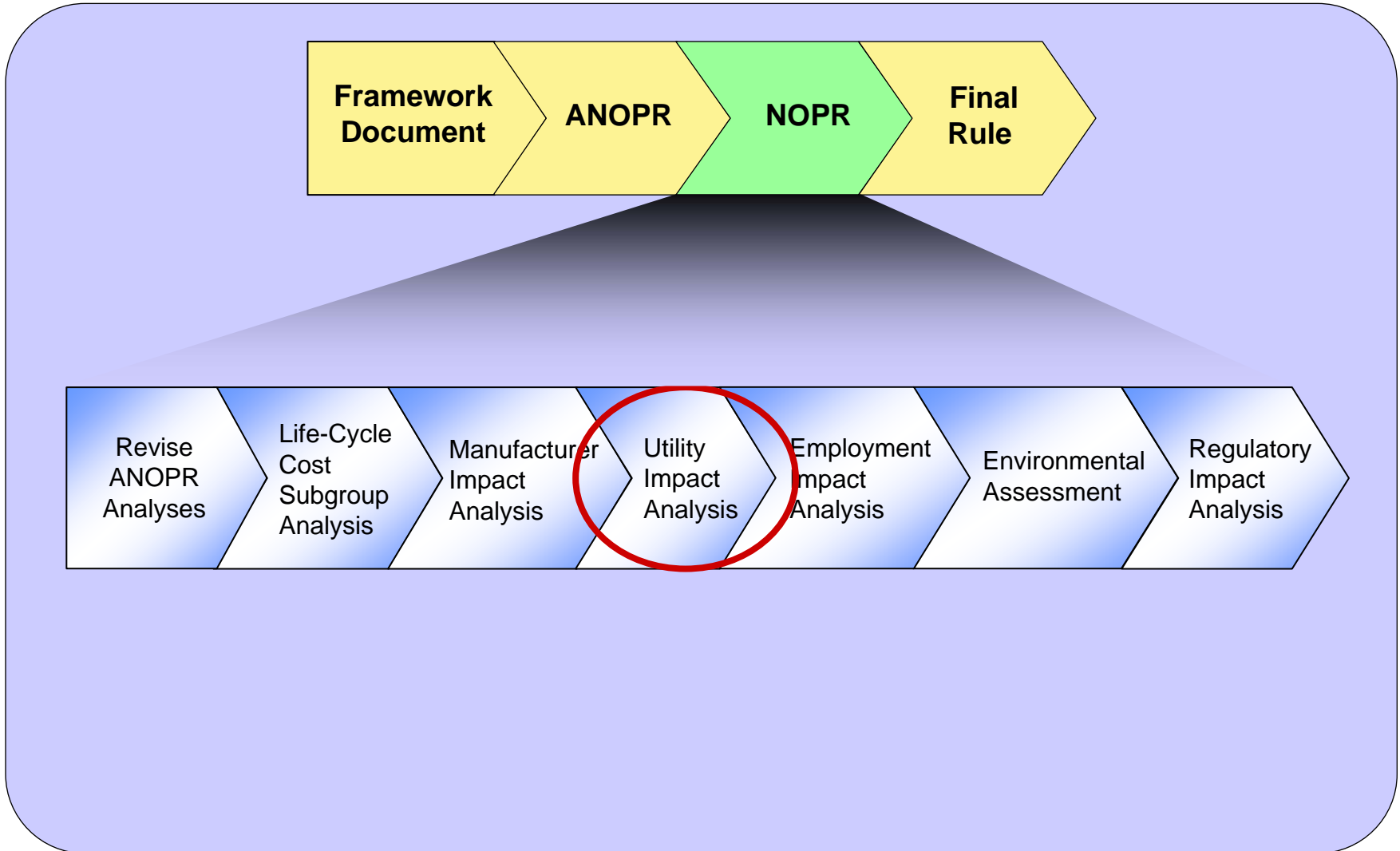



### Purpose

- Assess the overall impacts on domestic energy supplies that would result from the imposition of standards.

### Method

- The Department proposes to use NEMS-BT, a variant of the NEMS (National Energy Modeling System) developed and used by DOE/EIA for their Annual Energy Outlook report, as the basis of the Utility Impact Analysis.
- Use the energy savings calculated from the NES spreadsheet analysis to reduce the sector electrical loads from the Commercial Building Demand Module in NEMS-BT.
- Energy savings translated to a reduction in the electrical demand faced by the utility system over time.

**Item 13-1** The Department seeks input from stakeholders on its proposed use of NEMS-BT to conduct the utility impact analysis.



# Analyses for Notice of Proposed Rulemaking

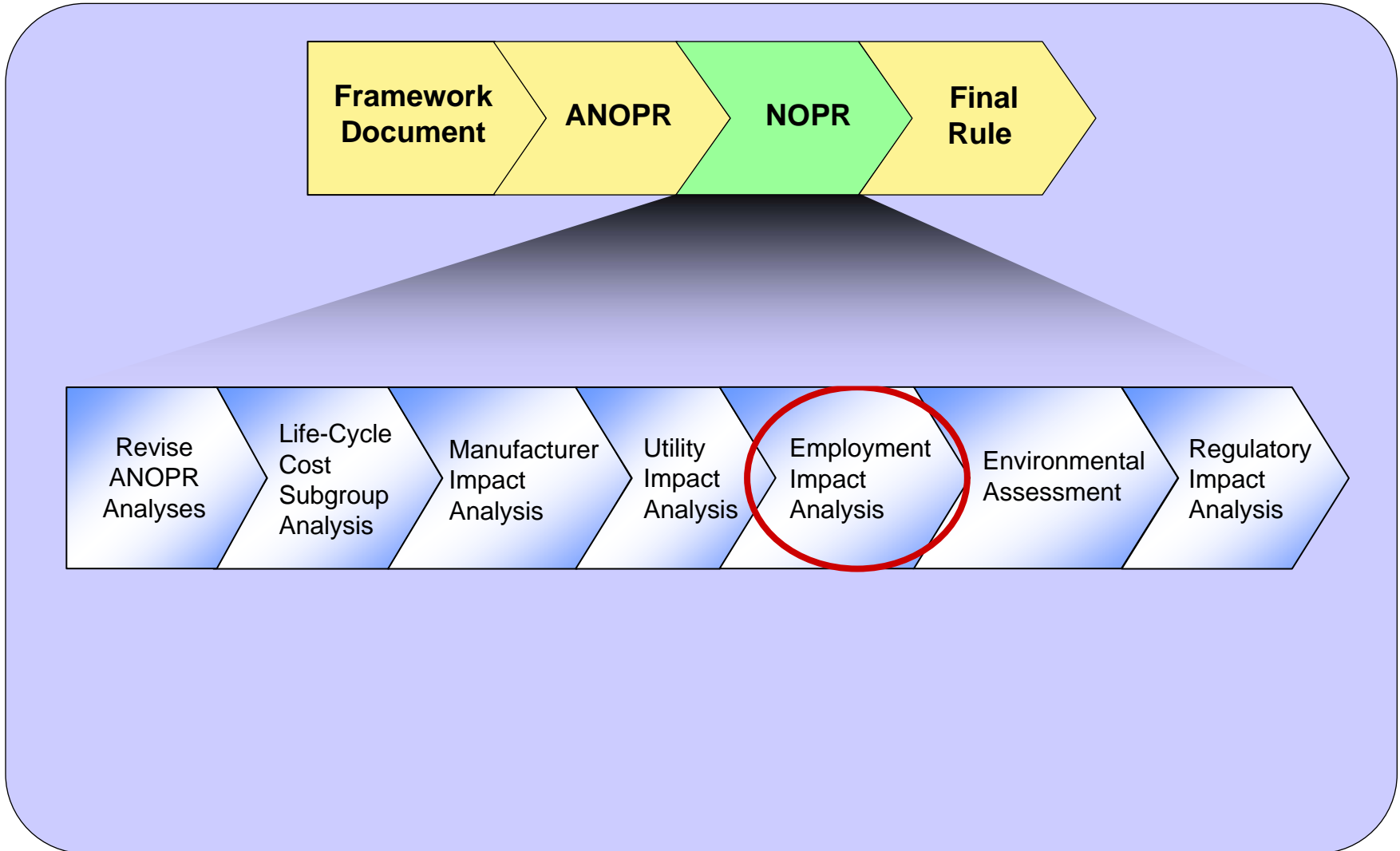



### Purpose

- Assess the overall impact on national employment from the imposition of efficiency standards at differing levels.
- Include both direct and indirect employment impacts
  - Direct employment impacts are estimated in the manufacturer impact analysis
  - Indirect employment impacts result from shifting consumer expenditures among goods and services ( “substitution effect”) and changing equipment and energy costs (“income effect”)

### Method

- The Department intends to use the IMSET (Impact of Sector Energy Technologies) model for the evaluation of indirect employment impacts.

**Item 14-1** The Department requests feedback on this approach to assessing employment impacts



# Analyses for Notice of Proposed Rulemaking

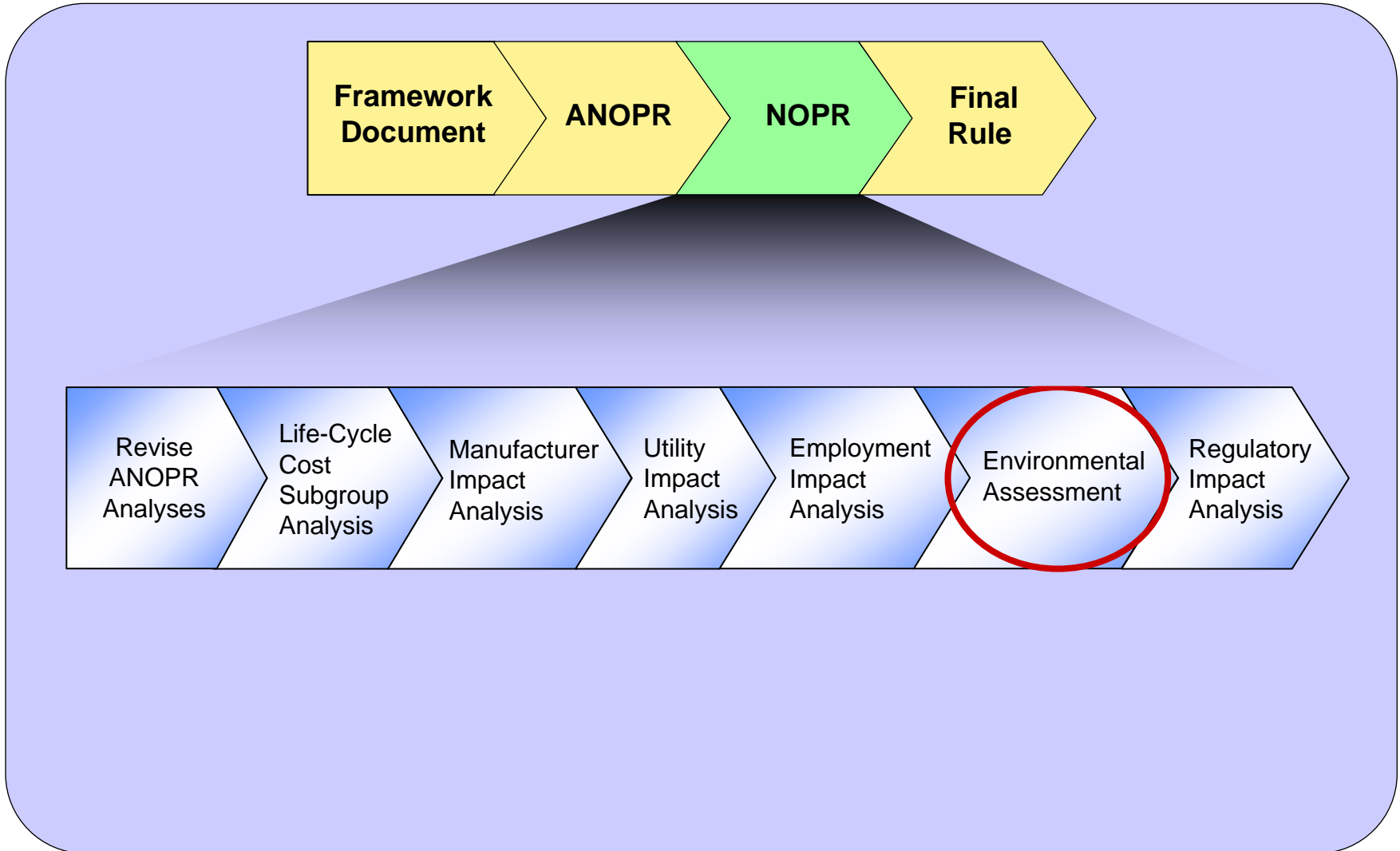



## Purpose

- Estimate national environmental impacts from new energy efficiency standards for commercial refrigeration equipment covered under this rule.

## Method

- The Department intends to use the environmental impacts predicted from the NEMS-BT modeling analysis used for the Utility Impacts Analysis. Impacts calculated within NEMS include:
  - Quantities of U.S. emissions ( $\text{CO}_2$ ) and nitrogen oxides ( $\text{NO}_x$ ) from power plants
  - Direct environmental Impacts from reduction of fossil fuel use at the building level.
  - Any measurable impact from NEMS in terms of the trading price of sulfur dioxide ( $\text{SO}_2$ ) in the utility sector and subsequent impact on  $\text{SO}_2$  emissions.

**Item 15-1** The Department requests feedback on this approach to assessing environmental factors.



# Analyses for Notice of Proposed Rulemaking

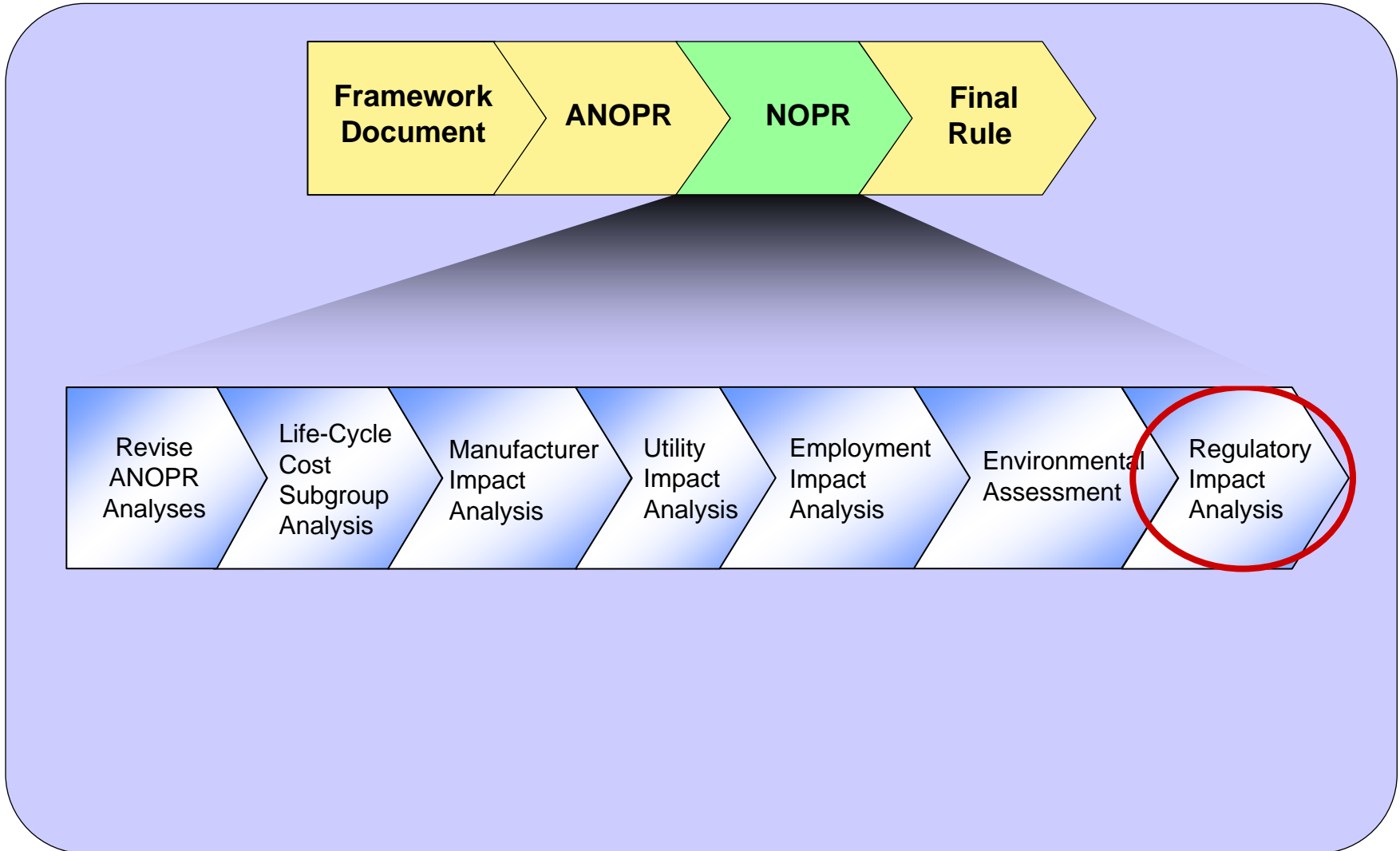



## Purpose

- Explore the potential for non-regulatory alternative to new manufacturing efficiency standards

## Method

- Base the assessment on the actual impacts of any such initiatives to date, but will consider information presented regarding the impacts that any existing initiative might have in the future

**Item 16-1** The Department is unaware of any current non-regulatory programs that specifically target the commercial refrigeration equipment covered under this rulemaking. Are stakeholders aware of any such programs that should be examined as optional, non-regulatory approaches?

**Item 16-2** Are there specific subgroups of end-users whom the Department should consider in its review of potential adverse impacts from standards developed under this rulemaking?



## Public Meeting Agenda

- 1 Introduction
- 2 Rulemaking Overview
- 3 ANOPR Analyses
- 4 NOPR Analyses
- 5 Final Rule Analyses**
- 6 Closing Remarks



## Analyses for Final Rule

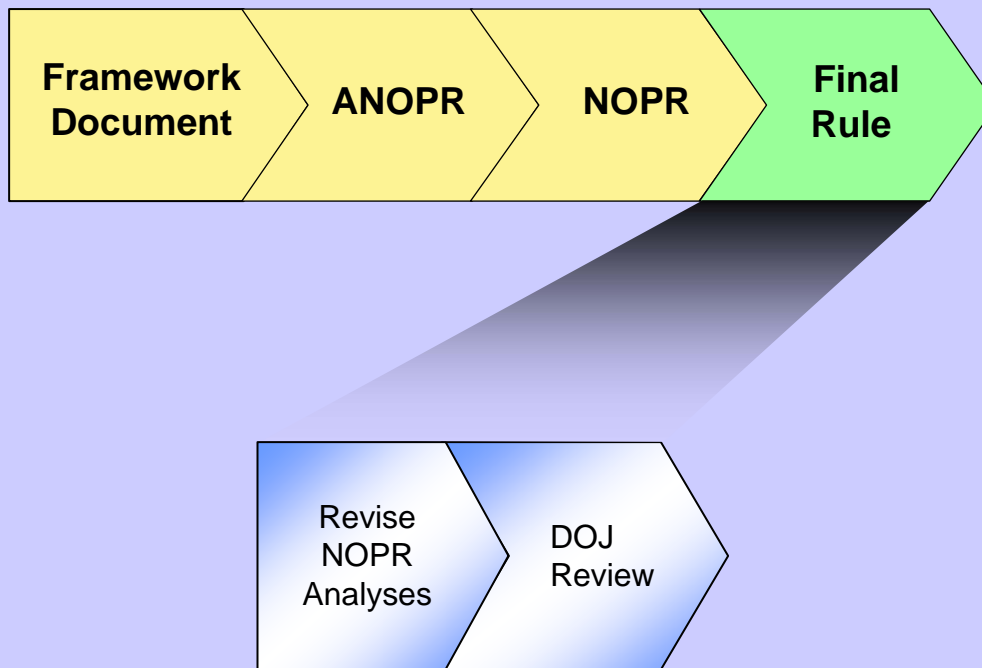



## Public Meeting Agenda

- 1 Introduction
- 2 Rulemaking Overview
- 3 ANOPR Analyses
- 4 NOPR Analyses
- 5 Final Rule Analyses
- 6 Closing Remarks



## Thank you. For more information...

- Website:

[http://www.eere.energy.gov/buildings/appliance\\_standards/](http://www.eere.energy.gov/buildings/appliance_standards/)

[http://www.eere.energy.gov/buildings/appliance\\_standards/commercial/commercial\\_refrigeration.html](http://www.eere.energy.gov/buildings/appliance_standards/commercial/commercial_refrigeration.html)

- Written comments

- The comment period will be open until **May 30, 2006**. Please reference the rulemaking docket number **EE-2006-STD-0126** and/or RIN number **1904-AB59**, in all correspondence.

**Email:** commercialrefrigeration.rulemaking@ee.doe.gov

**Mail:** Ms. Brenda Edwards-Jones  
U.S. Department of Energy  
Building Technologies Program, Mail stop EE-2J  
Framework for Commercial Refrigeration Equipment, RIN 1904-AB59  
1000 Independence Avenue, SW  
Washington DC, 20585-0121

**Courier:** Ms. Brenda Edwards-Jones  
U.S. Department of Energy  
Building Technologies Program, 1J-018  
1000 Independence Avenue, SW  
Washington DC, 20585-0121

- Contact:

- Mr. James Raba, telephone: (202) 586-8654, or e-mail: [jim.raba@ee.doe.gov](mailto:jim.raba@ee.doe.gov)



## Last Word

- **Review key decisions or accomplishments**
- **Identify next steps**
  - **Action items**
  - **People responsible**
  - **Due dates**
- **Evaluate session effectiveness**