



the Energy to Lead

Renewable Natural Gas Clean-up Challenges and Applications

Renewable Resource Webinar

July 13, 2011

Brian Weeks, Gas Technology Institute

281 235 7993, brian.weeks@gastechnology.org

Kristine Wiley, Gas Technology Institute

847 768 0910, kristine.wiley@gastechnology.org

Today's Talk

- > **Who is GTI**
- > **What is Renewable Natural Gas (RNG)**
- > **Challenges for Renewable Natural Gas**
- > **How do we clean up RNG?**
- > **Recommendations and Summary**

GTI at a Glance...

- > Not-for-profit research, with 65+ year history
- > Facilities
 - 18 acre campus near Chicago
 - 200,000 ft², 28 specialized labs
- > \$60 + million in revenue
- > Staff of 250
- > A growing business
- > Commercial partners take our technologies to market



Offices
& Labs



Flex-Fuel
Test
Facility



Energy & Environmental Technology Center

Gas Quality and RNG Clean-up

A Sustainable Gas Network Will Include Renewable Sources

Gas Distributors increasingly asked to accept renewable gas.

Pipeline tariffs generally don't address "trace" constituents.

Existing clean-up methods are generally intended for on-site use.

Little data on impact of constituents on pipelines or end use equipment

Gas quality research also important for unconventional shale gas supplies.

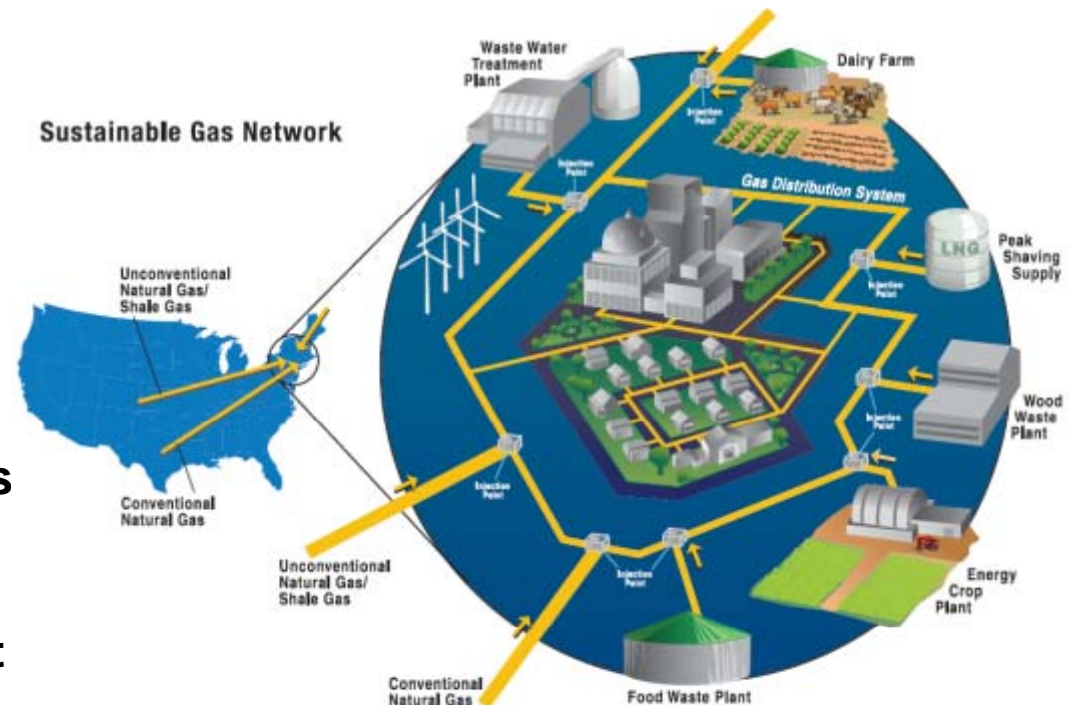

National Grid, Renewable Gas, "Vision for a sustainable gas network", 2010

Renewable Natural Gas is...

- > Methane produced from digesters
 - Animal manure (dairy cows, swine)
 - Waste water treatment facilities
- > Methane from Landfills
- > RNG produced from thermal chemical processes like gasification utilizing renewable feed-stocks including forest residues and agricultural wastes.



RENEWABLE NATURAL GAS CAN BE CLEANED-UP AND PLACED IN THE NATURAL GAS PIPELINE SYSTEM

GTI RNG Project Examples

> Example GTI Projects:

- Gills Onions—Anaerobic digestion of agricultural waste for on-site electricity generation
- Altamont Landfill—Landfill gas (LFG) cleanup for production of liquefied natural gas (LNG) for vehicle fuel
- Ft. Lewis —Anaerobic digestion of waste water for production of hydrogen as a fuel cell vehicle fuel
- SCRA * – Landfill gas (LFG) cleanup and on-site reformation to generate hydrogen for MHE in S.C.

*Project pending final authorization

Difference between “Conventional Gas” and “Renewable Natural Gas”

- > Conventional gas is 95% - 98% methane (CH₄)*
 - Constituents are well understood
 - Utility and Interstate pipeline tariffs account for typical components
 - Methods for treating “raw” gas are proven and in-place
- > RNG is also 95% - 98% methane*
 - Constituents are not as well understood
 - Utility and Interstate pipeline tariffs don’t typically address all components
 - Methods for treating “raw” biogas can be costly

*Post clean-up. Methane percentage could be lower in some cases

Trace Constituents Possibly Found in RNG

- > CO₂ & O₂ found at % to ppm level concentrations. Tariff limits typical 1-2% CO₂ & 0.2% O₂
- > Sulfur Compounds (H₂S). Typical tariff is 0.25 grain/100SCF for H₂S and 1 grain/100scf total sulfur
- > Inerts (N₂, He) and H₂
- > Halocarbon compounds
- > Volatile Organics (BTEX, aldehydes, ketones)
- > Ammonia / Amines
- > Siloxanes
- > Mercury and Other Elementals
- > Bacteria and MIC

Focus Areas for Improvement Renewable Natural Gas Utilization

- > Supply Stability: Variability in composition & supply
- > Impact on Infrastructure / Pipeline Integrity: CO₂, water, H₂, sulfur compounds, NH₃, bacteria, etc.
- > Impact on end use applications:
 - CO₂, CO, H₂ > flame stability, engine knock
- > Safety – Odorization & leak detection
- > Contaminant Disposal – Cleanup media generally not recyclable
- > Little analysis has been performed on biogas for fuel cell applications

Supply Stability

- > Volume variability introduces process configuration challenges
- > Constituents can vary seasonally – or even more frequently
- > Most stable supplies are dairy and swine yards

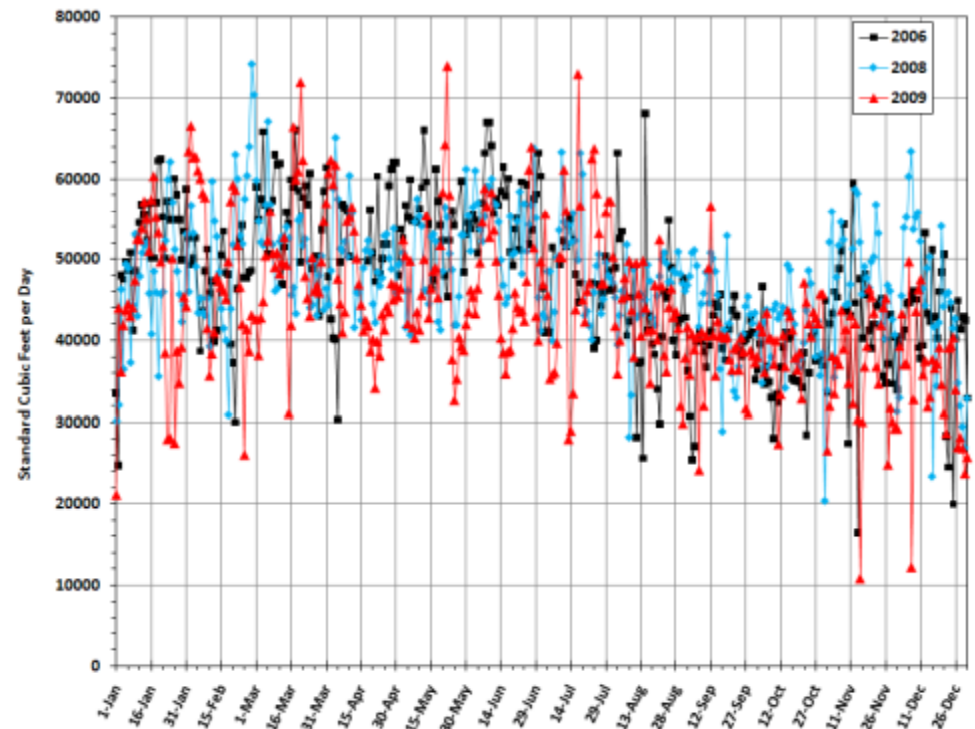

Daily WWDG Variability on a GTI ongoing project

Why Treat RNG?

Impact on Pipeline Infrastructure

- > Acid formation from sulfur compounds, carbonic acids, halocarbons or certain bacteria, promoting corrosion
- > Deposits from contaminants
- > Emissions from VOCs introduced into pipeline
- > Water collection



Why Treat RNG?

Impact on End Use Applications



- > Gas heating value / Wobbe number diminished by inerts in the gas stream
- > Deposits from contaminants
- > Emissions from VOCs introduced into pipeline
- > NO_x formation from ammonia compounds

High CO₂ flame / normal gas flame



Gas with high CO₂ content



Pipeline quality natural gas

Amell, A. (2007). Influence of altitude on the height of blue cone in a premixed flame. *Applied Thermal Engineering*, 27 (2-3), 408-412.

Normal gas flame / High H₂/CO flame

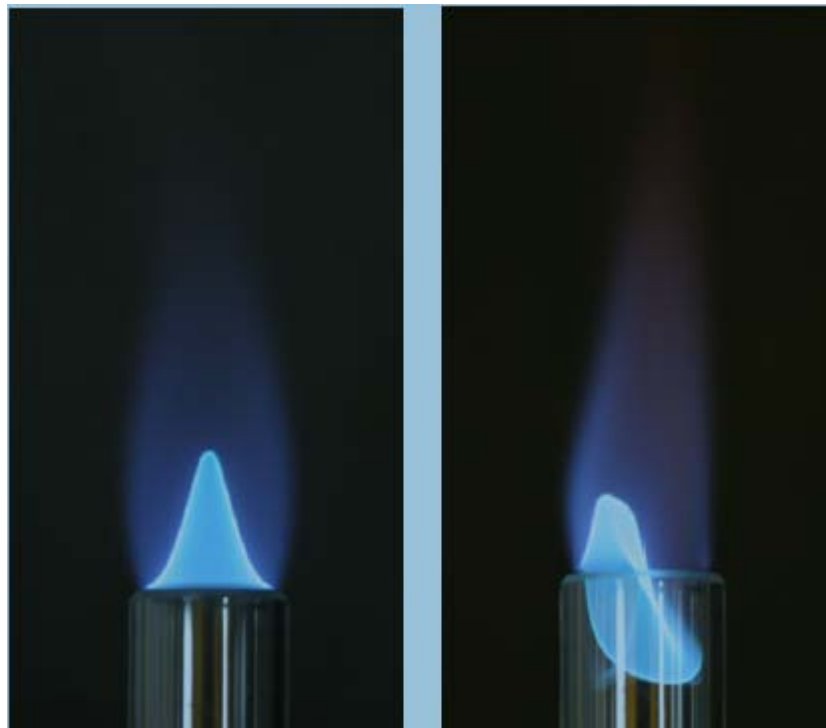

H. Levinsky, KEMA, University of Groningen,
The Netherlands

Why Treat RNG?

Impact on Fuel Cell Applications

> Impact on Reformer

> Impact on Fuel Cell

- VOC's – Coking
- Sulfur compounds – catalyst contamination and deactivation
- Siloxanes – silica compounds can coat fuel cell component surfaces and negatively impact performance
- Halogens (Chlorine, fluorine, etc) – poison catalyst
- Mercury and other elementals - catalyst poison and stack contaminant

Now that we understand the problem, What's the solution?

- > Hydrogen generation system from RNG will consist of three key components
 - Renewable natural gas cleanup system (H_2S , CO_2 , H_2O removal)
 - Biomethane reformation system (Steam-methane reformation — 75-80% efficient)
 - Hydrogen purification (remaining impurities removed including CO , CO_2 , CH_4)

Illustrative Process Flow Diagram for On-site H₂ Supply System & SOFC Power Generation (Hydrogen Fuel Production at 50kg/day)

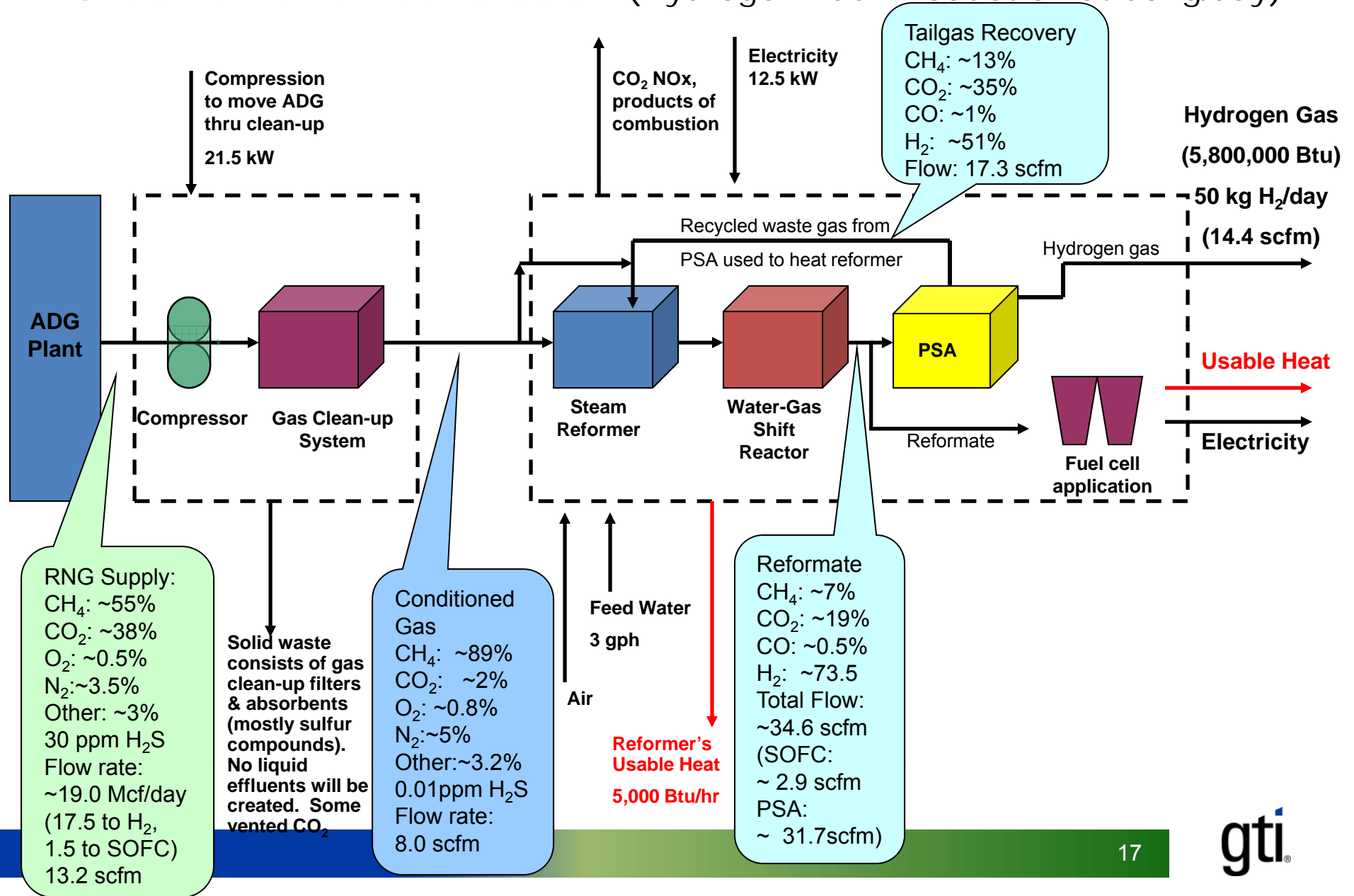

Illustrative Gas Cleanup System for WWDG

(not necessarily typical)

- > Configured a gas cleanup system utilizing a membrane module for CO₂ separation after H₂S removal
 - Passive system – no moving parts, for increased reliability
 - Ease of operation – virtually no maintenance requirements
 - Ease of Installation – modular and lightweight and can be operated at wide turndown ratio

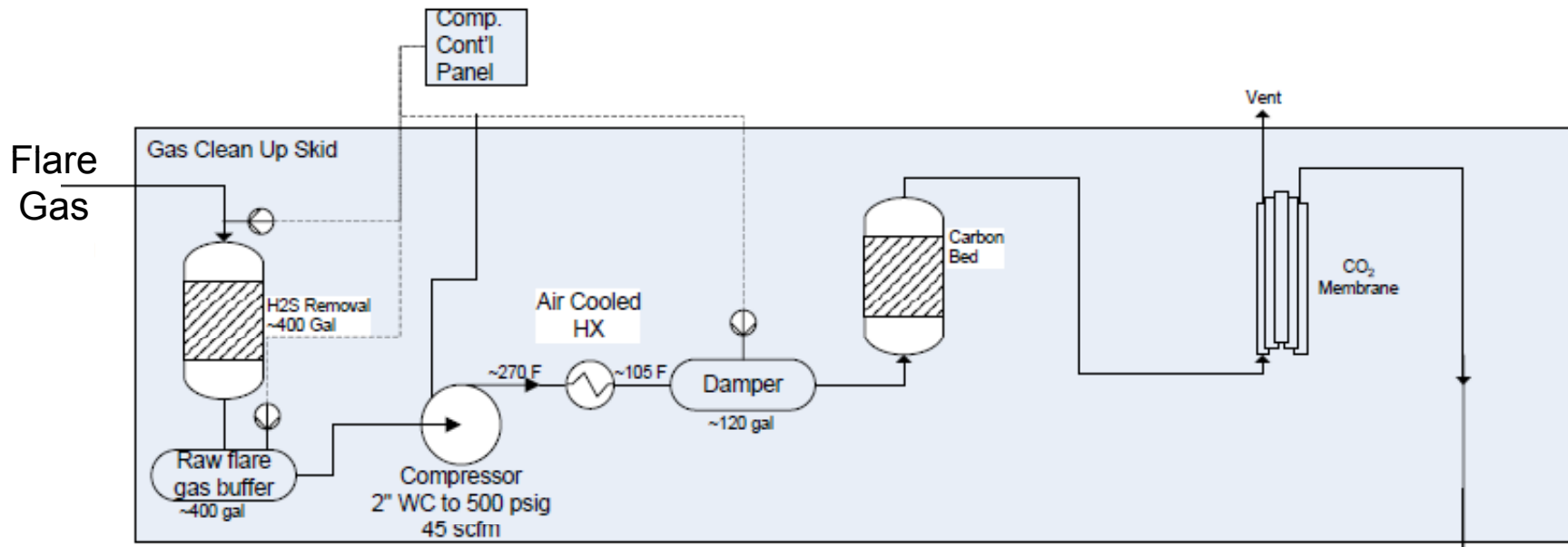

To Reformer

Removal of Trace Constituents

The Technology is here – need cost reduction

> Volatile Organics

- Zeolites
- Silica gel / adsorbents

> Sulfur compounds

- Activated carbon
- Zinc oxide
- Other – biofiltering, hydro desulfurization

> Siloxanes

- Adsorption on activated carbon bed
- Absorption in solvents
- Adsorption on polymorphous graphite

GTI Gas Quality Initiatives

- > Dairy Waste Biomethane Guidance Document
- > Landfill Gas Renewable Methane Guidance Document
 - Develop baseline for expected constituents
 - Analyze clean-up techniques (membrane, reactants, PSA)
- > Constituent Impact on Operations & End Use Applications
- > Gas Quality Sensor Development (real time monitoring for RNG)
- > Unconventional and Conventional Gas Trace Constituent Analysis
- > Gas Quality Resource Center

Gas Quality Resource Center

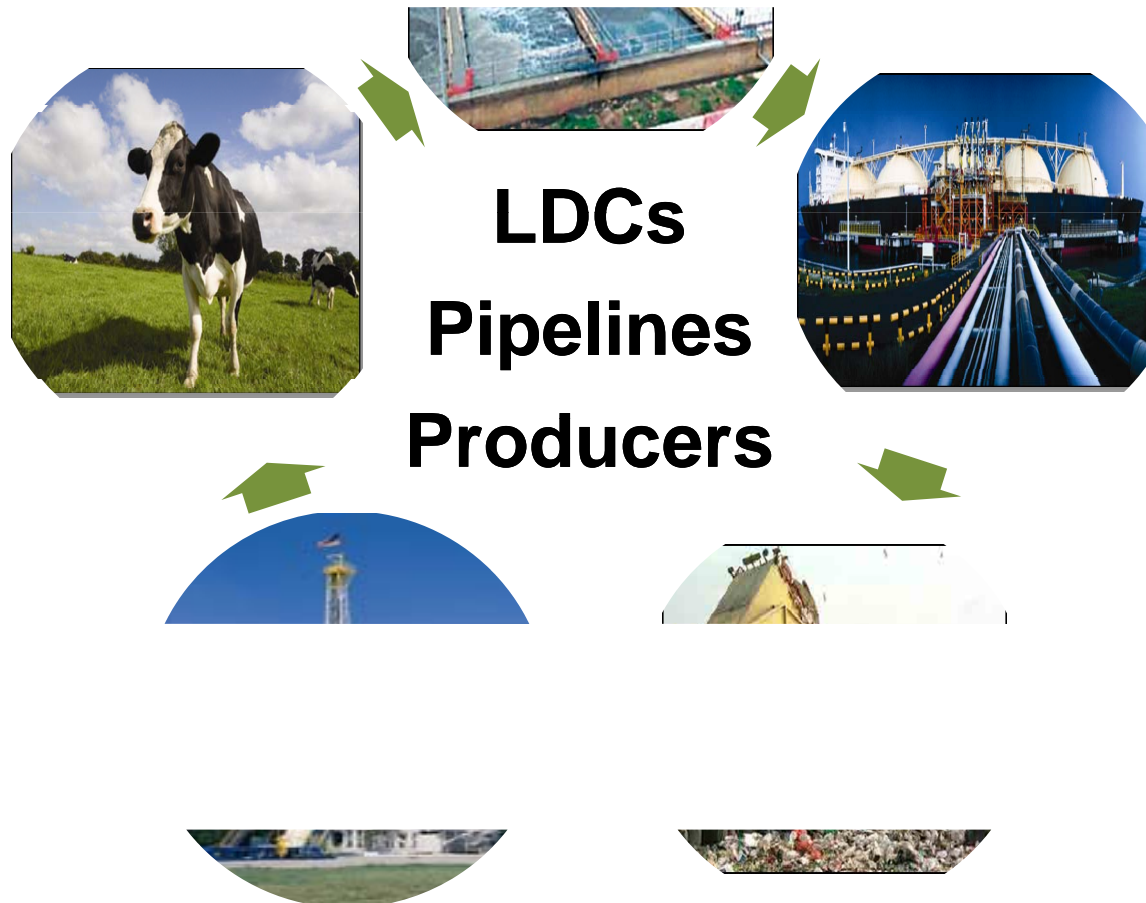

GQRC Considerations and Impacts

“Do we know what we don’t know?”

How do we manage/get access to information, and what does it mean for us?

Are producers utilizing suitable clean-up technologies ?

What are the current government policies and regulations impacting gas quality (FERC open documents)?



Gas Quality from a Regional perspective (historic and trending)?

How do we address variances in quality from the same source (Marcellus)?

How is it impacting our infrastructure and the end user (Interchangeability)?

How do we actively monitor the gas to ensure sustainable Quality?

What are the current best practices regarding elemental sulfur analysis?

GQRC Vision for Sustainability

Advisory Committee and Membership driven

- > Development of Web Based Resource Database
 - “Google with Intelligence”
 - Clearinghouse for Gas Quality Information
- > Development of Targeted Information “Modules”
- > Provide on-going Informational and Technical Gap Analysis
- > Create Community of Industry GQ Experts Across Sectors Address “Aging Workforce”

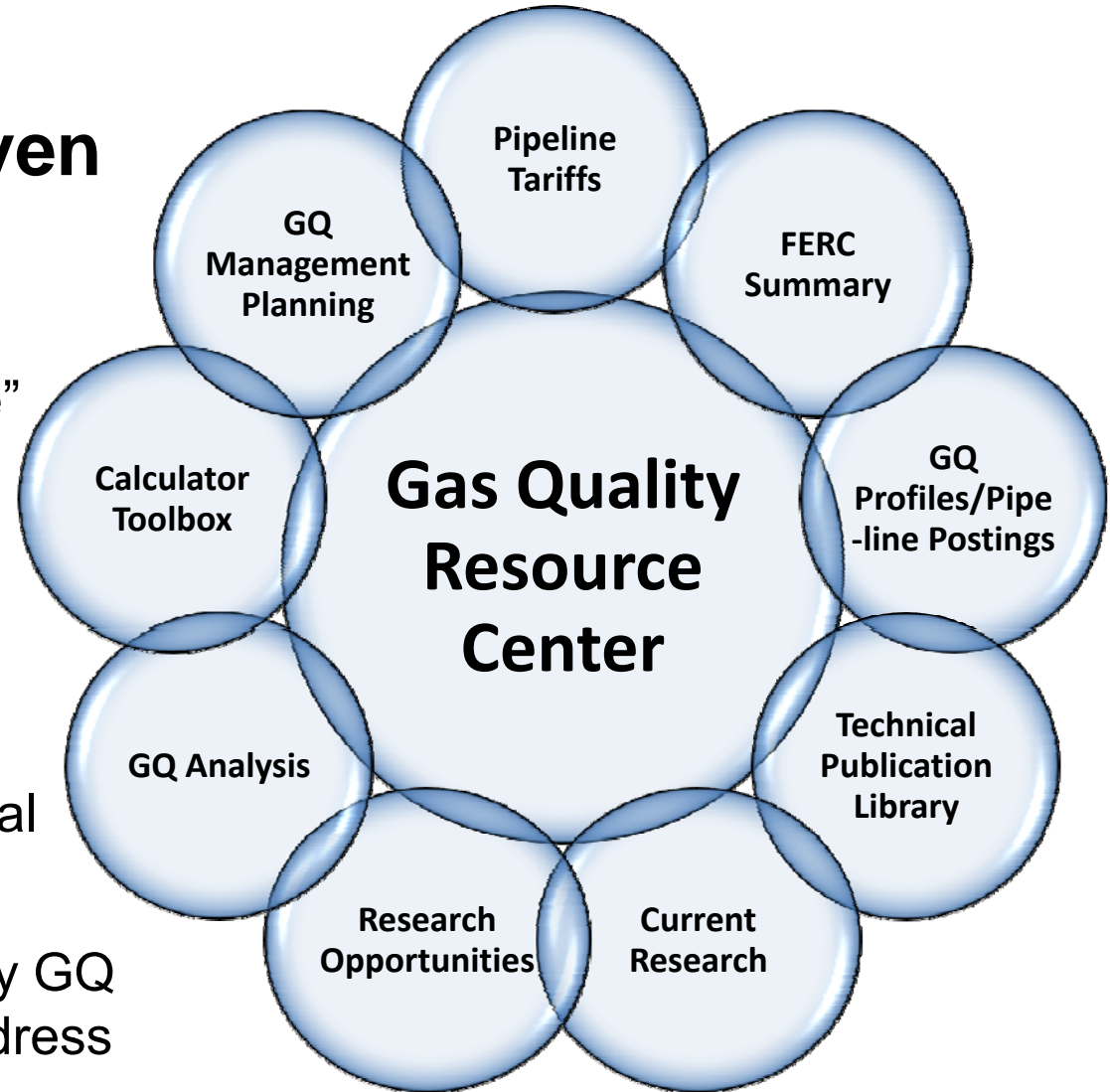

R&D Recommendations

- > Develop resource baseline data to better understand digester gas and landfill gas production (volumetric & constituent variability)
- > Initiate data analysis for operation of end use equipment (including fuel cell) with various levels of contaminants found in biogas to establish operating parameters.
- > Develop recycling technologies for gas clean-up techniques that can reduce O&M costs.
- > Assess performance of existing clean-up systems in various environments.
- > Perform economic analysis on optimal end-use application for renewable natural gas; vehicle fuel, pipeline injection, electricity generation, etc.
- > Broader support for gas quality analysis initiatives

Summary

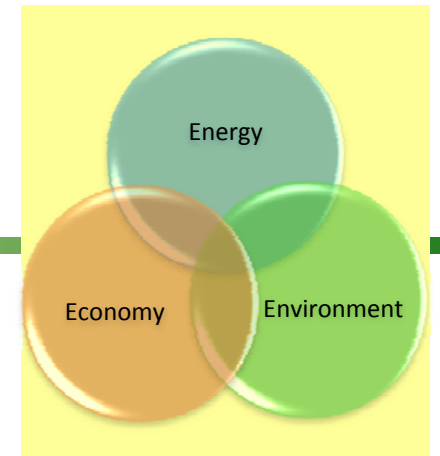

>Renewable Natural Gas

- Other than wind and solar, may be the lowest carbon renewable fuel available today
- RNG is being successfully injected into pipeline supply at over two dozen sites in the U.S.
- Additional analysis can help to reduce clean-up costs by better understanding constituent components and their potential impact on pipeline operations and consumers.
- Need to reduce costs of clean-up methods.
- Renewable Natural Gas is an increasing part of the supply portfolio – need better understanding of the resource in order to maximize the opportunity.



**Creating
technology solutions
with **impact****

▼
**across the
energy spectrum**

*Thank you for being interested
in clean, reliable energy!*

For more information:

Brian Weeks

Phone: 281 235-7993

brian.weeks@gastechnology.org

Kristine Wiley

Phone: 847 768-0910

kristine.wiley@gastechnology.org